

ISSN 2518-1483 (Online),
ISSN 2224-5227 (Print)

2020 • 5

ҚАЗАҚСТАН РЕСПУБЛИКАСЫ
ҰЛТТЫҚ ҒЫЛЫМ АКАДЕМИЯСЫНЫҢ

БАЯНДАМАЛАРЫ

ДОКЛАДЫ

НАЦИОНАЛЬНОЙ АКАДЕМИИ НАУК
РЕСПУБЛИКИ КАЗАХСТАН

REPORTS

OF THE NATIONAL ACADEMY OF SCIENCES
OF THE REPUBLIC OF KAZAKHSTAN

PUBLISHED SINCE 1944



ALMATY, NAS RK

Бас редакторы
х.ғ.д., проф., ҚР ҰҒА академигі
М.Ж. Жұрынов

Редакция алқасы:

Адекенов С.М. проф., академик (Қазақстан) (бас ред. орынбасары)
Бенберин В.В., проф., академик (Қазақстан)
Березин В.Э., проф., корр.-мүшесі (Қазақстан)
Величкин В.И. проф., корр.-мүшесі (Ресей)
Вольдемар Вуйцик проф. (Польша)
Елешев Р.Е., проф., академик (Қазақстан)
Жамбакин Қ.Ж., проф., академик (Қазақстан)
Иванов Н.П., проф., академик (Қазақстан)
Илолов М.И. проф., академик (Тәжікстан)
Кригер Виктор проф. (Германия)
Кененбаев С.Б., проф., академик (Қазақстан)
Леска Богуслава проф. (Польша)
Локшин В.Н. проф., академик (Қазақстан)
Неклюдов И.М. проф., академик (Украина)
Нур Изура Удзир проф. (Малайзия)
Нургожин Т.С., проф., корр.-мүшесі (Қазақстан)
Перни Стефано проф. (Ұлыбритания)
Потапов В.А. проф. (Украина)
Прокопович Полина проф. (Ұлыбритания)
Рамазанов Т.С. проф., академик (Қазақстан)
Раманкулов Е.М., проф., корр.-мүшесі (Қазақстан)
Садықұлов Т., проф., академик (Қазақстан)
Семенов В.Г., проф., академик (Россия)
Сикорски Марек проф., (Польша)
Такибаев Н.Ж. проф., академик (Қазақстан), бас ред. орынбасары
Уразалиев Р.А., проф., академик (Қазақстан)
Харин С.Н. проф., академик (Қазақстан)
Харун Парлар проф. (Германия)
Чечин Л.М. проф., корр.-мүшесі (Қазақстан)
Энджун Гао проф. (Қытай)

«Қазақстан Республикасы Ұлттық ғылым академиясының баяндамалары»

ISSN 2518-1483 (Online),

ISSN 2224-5227 (Print)

Меншіктенуші: «Қазақстан Республикасының Ұлттық ғылым академиясы» Республикалық қоғамдық бірлестігі (Алматы қ.).

Қазақстан Республикасының Ақпарат және қоғамдық даму министрлігінің Ақпарат комитетінде 29.07.2020 ж. берілген № KZ93VPY00025418 мерзімдік басылым тіркеуіне қойылу туралы куәлік.

Тақырыптық бағыты: *наноматериалдар алу, биотехнология және экология саласындағы бірегей зерттеу нәтижелерін жариялау.*

Мерзімділігі: жылына 6 рет.

Тиражы: 500 дана.

Редакцияның мекенжайы: 050010, Алматы қ., Шевченко көш., 28; 219, 220 бөл.; тел.: 272-13-19, 272-13-18,
<http://reports-science.kz/index.php/en/archive>

© Қазақстан Республикасының Ұлттық ғылым академиясы, 2020

Типографияның мекенжайы: «NurNaz GRACE», Алматы қ., Рысқұлов көш., 103.

Главный редактор
д.х.н., проф., академик НАН РК
М. Ж. Журинов

Редакционная коллегия:

Адекенов С.М. проф., академик (Казахстан) (зам. гл. ред.)
Бенберин В.В., проф., академик (Казахстан)
Березин В.Э., проф., чл.-корр. (Казахстан)
Величкин В.И. проф., чл.-корр. (Россия)
Вольдемар Вуйцик проф. (Польша)
Елешев Р.Е., проф., академик (Казахстан)
Жамбакин К.Ж., проф., академик (Казахстан)
Иванов Н.П., проф., академик (Казахстан)
Илолов М.И. проф., академик (Таджикистан)
Кригер Виктор проф. (Германия)
Кененбаев С.Б., проф., академик (Казахстан)
Леска Богуслава проф. (Польша)
Локшин В.Н. проф., академик (Казахстан)
Неклюдов И.М. проф., академик (Украина)
Нур Изура Удзир проф. (Малайзия)
Нургожин Т.С., проф., чл.-корр. (Казахстан)
Перни Стефано проф. (Великобритания)
Потапов В.А. проф. (Украина)
Прокопович Полина проф. (Великобритания)
Рамазанов Т.С. проф., академик (Казахстан)
Раманкулов Е.М., проф., чл.-корр. (Казахстан)
Садыкулов Т., проф., академик (Казахстан)
Семенов В.Г., проф., академик (Россия)
Сикорски Марек проф., (Польша)
Такибаев Н.Ж. проф., академик (Казахстан), зам. гл. ред.
Уразалиев Р.А., проф., академик (Казахстан)
Харин С.Н. проф., академик (Казахстан)
Харун Парлар проф. (Германия)
Чечин Л.М. проф., чл.-корр. (Казахстан)
Энджун Гао проф. (Китай)

Доклады Национальной академии наук Республики Казахстан»

ISSN 2518-1483 (Online),

ISSN 2224-5227 (Print)

Собственник: Республиканское общественное объединение «Национальная академия наук Республики Казахстан» (г. Алматы).

Свидетельство о постановке на учет периодического печатного издания в Комитете информации Министерства информации и общественного развития Республики Казахстан № **KZ93VPY00025418**, выданное 29.07.2020 г.

Тематическая направленность: *публикация оригинальных результатов исследований в области получения наноматериалов, биотехнологии и экологии.*

Периодичность: 6 раз в год.

Тираж: 500 экземпляров

Адрес редакции: 050010, г. Алматы, ул. Шевченко, 28; ком. 219, 220; тел. 272-13-19, 272-13-18,

<http://reports-science.kz/index.php/en/archive>

© Национальная академия наук Республики Казахстан, 2020 г.

Адрес типографии: «NurNaz GRACE», г. Алматы, ул. Рыскулова, 103.

E d i t o r i n c h i e f

doctor of chemistry, professor, academician of NAS RK

M.Zh. Zhurinov

E d i t o r i a l b o a r d :

Adekenov S.M. prof., academician (Kazakhstan) (deputy editor in chief)**Benberin V.V.**, prof., academician (Kazakhstan)**Berezin V.Ye.**, prof., corr. member. (Kazakhstan)**Velichkin V.I.** prof., corr. member (Russia)**Voitsik Valdemar** prof. (Poland)**Eleshev R.E.**, prof., academician (Kazakhstan)**Zhambakin K.Zh.**, prof., academician (Kazakhstan)**Ivanov N.P.**, prof., academician (Kazakhstan)**Iolov M.I.** prof., academician (Tadjikistan)**Krieger Viktor** prof. (Germany)**Kenenbayev S.B.**, prof., academician (Kazakhstan)**Leska Boguslava** prof. (Poland)**Lokshin V.N.** prof., academician (Kazakhstan)**Nekludov I.M.** prof., academician (Ukraine)**Nur Izura Udzir** prof. (Malaysia)**Nurgozhin T.S.**, prof., corr. member. (Kazakhstan)**Perni Stephano** prof. (Great Britain)**Potapov V.A.** prof. (Ukraine)**Prokopovich Polina** prof. (Great Britain)**Ramankulov E.M.**, prof., corr. member. (Kazakhstan)**Sadykulov T.**, prof., academician (Kazakhstan)**Semenov V.G.**, prof., academician (Russia)**Sikorski Marek** prof., (Poland)**Ramazanov T.S.** prof., academician (Kazakhstan)**Takibayev N.Zh.** prof., academician (Kazakhstan), deputy editor in chief**Urazaliev R.A.**, prof., academician (Kazakhstan)**Kharin S.N.** prof., academician (Kazakhstan)**Kharun Parlar** prof. (Germany)**Chechin L.M.** prof., corr. member (Kazakhstan)**Endzhun Gao** prof. (China)**Reports of the National Academy of Sciences of the Republic of Kazakhstan.****ISSN 2224-5227****ISSN 2518-1483 (Online),****ISSN 2224-5227 (Print)**

Owner: RPA "National Academy of Sciences of the Republic of Kazakhstan" (Almaty).

The certificate of registration of a periodical printed publication in the Committee of information of the Ministry of Information and Social Development of the Republic of Kazakhstan **No. KZ93VPY00025418**, issued 29.07.2020.Thematic scope: *publication of original research results in the field of obtaining nanomaterials, biotechnology and ecology.*

Periodicity: 6 times a year.

Circulation: 500 copies.

Editorial address: 28, Shevchenko str., of. 219, 220, Almaty, 050010, tel. 272-13-19, 272-13-18,

<http://reports-science.kz/index.php/en/archive>

© National Academy of Sciences of the Republic of Kazakhstan, 2020

Address of printing house: «NurNaz GRACE», 103, Ryskulov str, Almaty.

Obtaining nanomaterials in the fields of natural sciences, medicine and agriculture

REPORTS OF THE NATIONAL ACADEMY OF SCIENCES
OF THE REPUBLIC OF KAZAKHSTAN

ISSN 2224-5227

<https://doi.org/10.32014/2020.2518-1483.112>

Volume 5, Number 333 (2020), 5 – 12

UDC57.084

IRSTI 34.35. 33

A. V. Ubaskin^{1,2}, N. E. Tarasovskaya³, K. I. Akhmetov¹, A. I. Lunkov²

¹Toraighyrov University, Pavlodar, Kazakhstan;

²LLP «Irtys Environmental Center», Pavlodar, Kazakhstan;

³ Pavlodar State Pedagogical University, Pavlodar, Kazakhstan.

E-mail: awupawl@mail.ru, kairat_akhmetov@mail.ru, al67kz@mail.ru

ON THE PROBLEM OF USING NATURAL BIOLOGICALLY ACTIVE SUBSTANCES TO ACTIVATE ARTEMIA EGGS

Abstract. Currently branchiopod from the genus of Artemia Leach, 1819 became the common starting feed №1 for growing young aquatic organisms. However, there is often reduced hatching of nauplius from the collected eggs and artificial activation is required. As a result of empirical research, it was possible to experimentally detect the activating effect of excretion products – diluted adult urine. The research was carried out in several stages. It was found that the rate of germination growth for different populations ranges from 0, 2 to 0, 6% per day. In the first experiment, cysts with 24% of hatching were placed in a solution of lake water diluted with urine to a concentration of 105 g/l. After two weeks, the outage reached 66. 7 % and exceeded the control 2.55 times. But over time, the activity of the embryos decreased and by the end of April, the hatching reached zero. By using eggs from the 1st experiment with 66. 9% hatching in a fresh solution of «lake water + urine» (105 g / l) on the first day, the hatching exceeded the control by 52. 1% and by 23.7% the data from experiment 1. Later, when 80.8% were hatched, a large number of weakened and dead nauplius was observed.

In the third experiment, spring egg with a hatching rate of 36. 7% was used. Different salinity concentrations (110-140 g/l) were used due to dilution of lake water (233 g/l) with urine and fresh water. When activated in a solution with a salinity of 110 g/l after one month, the discharge exceeded the control by 1. 65 times. At the end of the experiments, an increase in the salt concentration reduced the activating effect with a slight decrease in hatching. The mechanisms of activating action of the components of the proposed liquid folds the physiological effects of steroid hormone metabolites on the formation of the larva in the egg and the destructive physical and chemical effects of a number of substances on the egg shell. For complex activation of the development of the embryo with the destruction of egg's shells, savings are achieved in the plastic and energy substances available in the egg, preserving the nutritional value of nauplius.

Keywords: Artemia, eggs, shell, hatching of nauplius, urina.

Introduction. Currently branchiopod from the genus of Artemia Leach, 1819 became the common starting feed №1 for growing young aquatic organisms. The main problem with using Artemia eggs to get nauplius is a low percentage of hatching; that requires activities for the activation. For a long period and to the present time the development of methods for activating Artemia eggs by the action of various factors and reagents has been underway: light and magnetic field, ultraviolet rays, freezing, mechanical impact when grinding eggs with sand, chemical reagent (components, included in the salt solution, sodas and borax, hydrogen peroxide), organic solvents, (acetone, butane, ethyl alcohol), parapsychical impacts and mums, the literature review is given in [1-3].

The authors of this article, as a result of empirical research, were able to experimentally detect the activating effect of excretion products – dilute urine of an adult. The relevance of the research is that an incubating and activating medium for the cultivation of Artemia eggs has been developed, which is characterized by ease of manufacture, economic and technological feasibility.

Materials and methods. Artemia's eggs were collected for experiments in the autumn in salty reservoirs of the Pavlodar region. The hatching of nauplius was determined by using standard methods [4]. Determination of the size of the hatching was carried out under round-the-clock lighting, at a temperature of 25-28°C for 24 hours. In different variants of the experiments the salt brine was diluted with fresh urine of an adult to a certain concentration of salt. Quantitative data were processed using statistical methods [5].

Research results. At the first stage of research, was experimentally determined the amount of hatching of nauplius from autumn Artemis eggs in local reservoirs with different levels of salinity. During this period, the embryos reach the stage of gastrula and become close to the state of diapause, characterized by a sharp decrease in the intensity of metabolism and cease the forming processes, and have a low percentage of hatching nauplius. In spring, eggs in the reservoir usually have 72-99% hatch rate [6]. To achieve those values of maturation (germination) of eggs it should undergo through the activation process. The ability to hatch increases gradually during the period of egg storage in a humid environment. The rate of growth of the germination index varies for different populations and ranges from 0, 2 to 0, 6% per day. The conducted research has shown that for performing artificial activation of Artemia's eggs diapause, it is necessary to prepare salty environment of a certain concentration, taking into account the natural mineralization of the mother reservoir. The salinity gradients found in experiments that are optimal for hatching nauplius are most likely favorable for the targeted use of various activating reagents [7,8], including the isolation products used by the authors.

The second stage of experimental research consisted of activation of eggs in liquid environment with different proportions of the activating substance (adult urine) and salt lake water.

Experiment 1. Artemia's egg, collected in a lake with a mineralization of 285 g / l in early October, was stored in a humid environment at a temperature of minus 5 to minus 17°C. In mid-December, the outage rate was 24% (22. 4–25. 2). The egg sample was placed in a solution of lake water (natural salinity in the lake – 285 g/l), diluted with urine to a concentration of 105 g/l. Preliminary experiments have shown that this amount of mineralization is optimal for activation of crustacean eggs. During the experiments, the samples were stored at a temperature of + 4° – + 6°C. In the control, during the entire activation period, there was a gradual increase in the hatching rate. However, in General, the final result was very low (40. 4 %) and was almost 1. 7 times less for achievement the product standard (at least 70%)(figure 1).

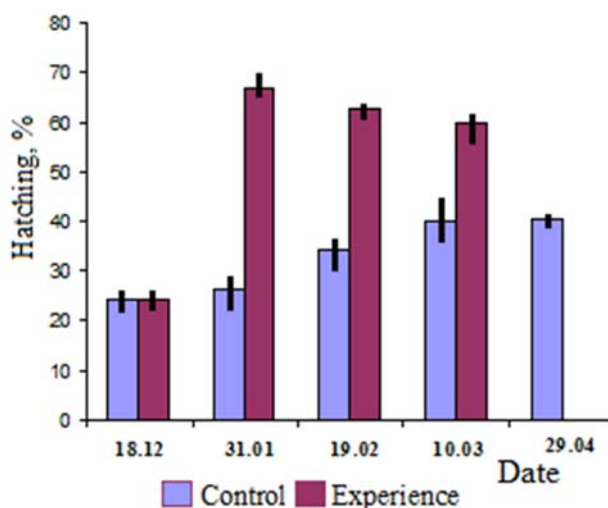

Figure 1–Hatching of Artemianauplius in a controlled and activated environment

The use of fresh urine in the activation solution stimulated the release of Artemianauplius, and in two weeks this indicator reached a value of 66. 7 %, exceeding the control value by 2. 55 times. In the future, the activity of the embryos began to decrease, and by the end of April, the offspring fell to zero.

Experiment 2. After the 1st experiment the hatching of the Artemia's egg reached 66. 9 % (31. 01), part of the experimental eggs were placed in a fresh solution of "lake water + urin" with a concentration of 105g/l. The distribution of the activation has been introduced in three different environments (figure 2).

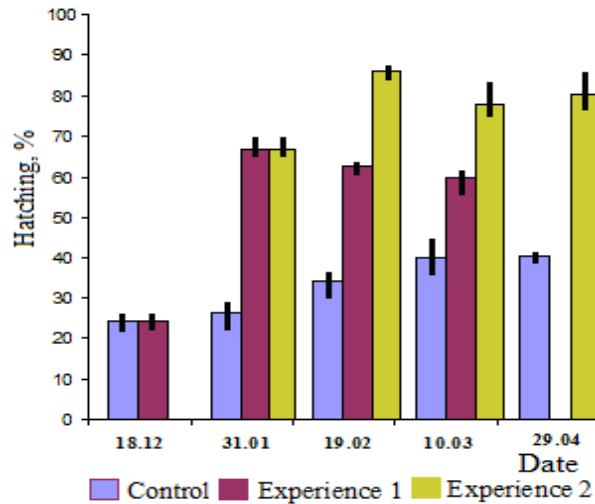

Figure 2 – Hatching of Artemia'snauplius in a controlled and activated environment

The fresh solution immediately stimulated high development of eggs, and after 19 days, hatching increased by 52.1% compared to the control and 23.7% exceeded the data of 1st experiment. In the future, a fairly high level of hatching was maintained, but on 29.04, when 80.8% were hatched, a large number of weakened and dead naupliuses were observed.

Experiment 3. An Artemia's egg collected in the spring (March) in a lake with a mineralization of 233g/l showed a very low percentage of hatching, total 36,7% (27,0 – 46,5).

The egg was laid for activation in various concentrations of salt and urine:

1. Lake water (natural salinity 233 g/l) is diluted with urine to a concentration of 110 g/l.
2. Lake water (233 g/l) is diluted with urine of 140 g/l.
3. Lake water (233 g/l) is diluted with urine to 150 g/l, and then diluted with addition of the fresh water to 140 g/l.
4. Lake water (233 g/l) is diluted with urine to 160 g/l, and then diluted with addition of the fresh water to 140 g/l.
5. Lake water (233 g/l) is diluted with urine to 170 g/l, and then diluted with addition of the fresh water to 140 g/l.

The main monitoring objects were eggs in a salt solution with a concentration of 140 g/l. Figure 3 shows data on the hatching of Artemia'snauplius after 20 and 30 days of activation. Salt concentrations before dilution with fresh water are shown in parentheses. The results of experiments showed that when Artemia's eggs are activated in a solution with a mineralization of 110 g/l, there is a constant growth of hatching, which in one month exceeded the control by 1.65 times. An increase in the salt concentration reduced the activating effect and there was even a slight decrease in hatching at the end of the experiments. Diluting the "lake water + urin" solution with fresh water to the required concentrations reduced the effectiveness of the solution, and at higher dilutions, complete death of the embryos was observed.

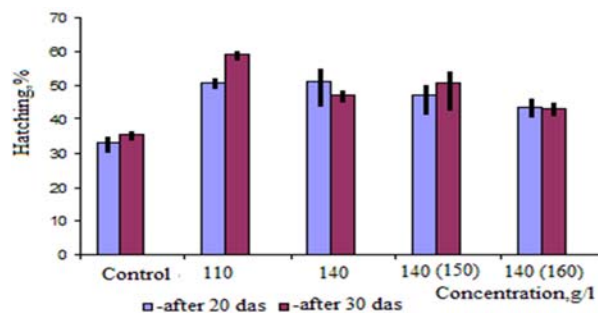

Figure 3 – Disabling Artemia'snauplius in a controlled and activated environment, %

Discussion of research results. The mechanisms of activating effects of the components of the proposed liquid are formed, on the one hand, from the physiological effects of steroid hormone metabolites on the formation of the larva in the egg, on the other – from the destructive physical and chemical effects of a number of substances on the egg shell.

Metabolites of adrenal cortex hormones (mineralocorticoids and glucocorticoids) contained in the urine of people and animals of any age [9] can have an activating effect on the development of the embryo of any animal by enhancing metabolic processes in tissues [10].

Metabolites of sex steroid hormones present in the urine of an adult (while in the female body, along with estrogens, a small amount of androgens is synthesized, and in the male body – estrogens), have an anabolic effect and contribute the formation of tissues and organs of the embryo. The destructive effect of the components of urine on the egg shell, which facilitates the exit of nauplius (and thus increases the viability of larvae, preserving their energy resources and increasing their feed value), is as follows. The egg shell of the arthropods consists of several layers and includes chitin, lipids, and tanned proteins. Urea, also known as carbamide, the content of which in human urine reaches 2%, and in the prepared activating liquid-about 1%, partially pollinating fats due to the alkaline reaction (which means that it converts them to a soluble state), softens tanned proteins, and then destroys their secondary and tertiary structure and leads to partial hydrolysis. Egg's shell passes liquid inside and undergoes further destruction. The properties of urea as a macerating substance are well known in biology and medicine (and find appropriate application where it is necessary to achieve partial or complete maceration of tissues). In practical biochemistry, urea is widely and successfully used to destroy the quaternary structure of proteins and supramolecular protein complexes (including antigen – antibody [11]).

In addition, urea and other organic substances – non-electrolytic, contained in the urine, are antagonists of salt ions. They contribute swelling of egg shells, performing, in fact, the same function as fresh water in the spring, formed when snow and ice melt on salt lakes. Proteins, partially hydrolyzed by urea, also attach water and swell, speeding up the overall process of destruction of the shell.

A certain role in the swelling of the egg shells could play the order of penetration of substances into the shell. Apparently, at first there is a partial destruction of the shell under the action of urea, and afterwards mobile sodium ions penetrate through the concentration gradient, and only then – organic substances available in the urine (urea, a small amount of other metabolic products, steroids). Sodium cations penetrate the hydrate shell and have water-retaining properties. Metabolites of steroid hormones also contribute swelling and further rupture egg's shells due to the fact that, penetrating into the shell, they delay sodium cations [12], which means that they contribute to the accumulation of liquid since monovalent cations have hydrating properties for living tissues [13].

Destruction of egg's shells promotes the penetration of oxygen, which also has a stimulating effect on the development of nauplius.

It is possible that with comprehensive activation in the development of the embryo with the destruction of egg shells, savings are achieved in the plastic and energy substances available in the egg.

First of all, the hatching nauplius does not spend extra energy on breaking the egg shells, which by the time the larva leaves are destroyed or significantly lose their strength. Secondly, the products of hydrolysis of proteins and lipids of the shell may well be assimilated by the embryo for plastic or energy needs. Secondly, the products of hydrolysis of proteins and lipids of the shell may be assimilated by the embryo for plastic or energy needs. Third, urea and other ultimate products of protein metabolism can inhibit excessive catabolic breakdown of proteins on the principle of auto-inhibition (thereby partially preventing the strengthening of protein catabolics caused by corticosteroid metabolites).

Fourth, metabolites of sex hormones (and especially androgens) enhance anabolic processes (and androgens are also present in the female body due to their synthesis by the adrenal glands). Fifth, corticosteroid metabolites contribute to the accumulation of sugars in tissues, thereby forming a stock of easily and quickly oxidizing energy substances [10].

The death of formed embryos in eggs at the attempt of trying to activate them with undiluted adult urine may be associated with several, not excluding each other, reasons.

First, a high concentration of urea could cause a violation of the structure and partial hydrolysis of proteins not only of the shells, but also of the embryo itself, whereas in dilute urine, urea is consumed for hydrolysis and destruction of shell proteins, and its concentration is insufficient to cause fatal changes in the tissues of the embryo.

Secondly, a high concentration of urea and other products of nitrogen metabolism can cause intoxication of the emerging and already formed embryo.

Third, urea, along with other products of nitrogen metabolism, contained in the urine, can suppress (and in high concentrations – irreversibly) the vital activity of any kind of living organisms on the principle of auto-inhibition [11].

Fourth, it is also possible that corticosteroids and their metabolites contained in the urine accelerate catabolic processes, thereby depriving the emerging, but not yet released nauplius protein and inhibiting its anabolic processes. Which means that such an embryo may not even have enough opportunities to exit the egg shells and start self-feeding; in addition, due to excessive catabolics of proteins, it may not be fully formed and is doomed to death.

Fifth, when using pure urine as an activating agent, without adding salt brine, the macerating effect of urea in the absence of salts is stronger and destroys the developing embryo.

It is somewhat more difficult to explain the facts of death of the formed larvae in cases when distilled water was added to the mixture of urine and lake salt brine – while maintaining the same concentration of salts in the prepared activating liquid. The following assumptions can be advanced.

In a dilute solution, urea is more susceptible to decomposition (hydrolysis) with the formation of a toxic product – ammonia, as well as carbon dioxide, which inhibits the life of the larva.

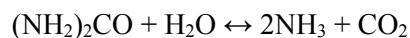

According to the law of mass activity (and the following law of Ostwald dilution), when a weak electrolyte (or a salt of a weak acid or a weak base, or other hydrolysable product) is diluted with water, both dissociation and hydrolysis processes are enhanced.

$$K = \alpha^2 \cdot C / (1 - \alpha),$$

where, C is the concentration of the substance, K is the constant, and α is the degree of decomposition of the substance (dissociation or hydrolysis).

Since the degree of dissociation α is very small and close to zero, it can be ignored in the denominator, and then:

$$K = \alpha^2 \cdot C \text{ or } C = K / \alpha^2,$$

in other words, there is an inverse relationship between the concentration and the degree of dissociation or hydrolysis [12].

When activating *Artemia*'s eggs with such a dilute urea, steroid hormones have a stimulating effect on the embryo, but the formed nauplius dies from the action of ammonia and carbon dioxide, which are released and penetrate into the shells as the eggs are kept in such an activating solution. This assumption is also supported by the facts noted in experiment 1: the long-term content of eggs in a brine + urine solution without replacing the activating liquid led to significant death of nauplius, which could be associated with the gradual decomposition of urea into ammonia and carbon dioxide. At the same time, replacing the activating solution with a fresh portion of it increased the yield of nauplius and did not reduce the viability of the larvae.

Thus, the use of the natural product of human and animal excretion in the proposed concentrations and in compliance with the specified terms of egg activation significantly increases the percentage of nauplius yield without reducing their viability and without accumulation of toxic or foreign substances for living organisms in the base feed facility.

А.В. Убаскин^{1,2}, Н.Е. Тарасовская³, К.И. Ахметов¹, А.И. Луньков²

¹Торайғыров университеті, Павлодар, Қазақстан;

²«Ертіс өңірінің экологиялық орталығы» ЖШС, Павлодар, Қазақстан;

³Павлодар мемлекеттік педагогикалық университеті, Павлодар, Қазақстан

АРТЕМИЯ ЖҰМЫРТҚАЛАРЫН БЕЛСЕНДІРУ ҮШІН ТАБИҒИ БИОЛОГИЯЛЫҚ БЕЛСЕНДІ ЗАТТАРДЫ ПАЙДАЛАНУ МӘСЕЛЕСІ БОЙЫНША

Аннотация. Қазіргі уақытта *Artemia Leach* тұқымының желбезекаяқтылар отрядының шаянтәрізділері 1819 жас гидробионттарды жасанды өсіру барысында бастапқы жем болып саналады. Дегенмен, жұмыртқалардан жиналған науплиус шығымының төмендегені байқалады және жасанды белсендіруді талап етеді. Эмпирикалық зерттеулер нәтижесінде тәжірибелі жолмен бөлу өнімдерін белсендіретін әрекет – ересек адамның сұйылтылған несепі екені анықталды. Зерттеулер бірнеше кезеңдерде жүргізілді.

Зерттеудің бірінші кезеңінде тәжірибелік жолмен эмбриондар диапауза жағдайына жақын болған кезеңде және табиғи белсендіруден кейінгі көктемгі кезеңде артемийдің күзгі жұмыртқаларынан науплиустардың шығу мөлшері анықталды. Әртүрлі популяцияларда орташа өсу қарқыны тәулігіне 0, 2-ден 0, 6%-ға дейін ауытқиды.

Эксперименталды зерттеулердің екінші кезеңі белсенді заттың (ересек адамның несепі) және тұзды көл суы қосылған сұйықтық ортада жұмыртқаны белсендіруден тұрады.

Бірінші тәжірибеде 24% шығымы бар цистадағы көл суының ерітіндісі 105 г/л концентрациясы бар несеппен араластырылды. Ерітіндіні активтендіруде жаңа несепті пайдалану Артемия науплиустар шығымын ынталандырды және екі аптадан кейін бұл көрсеткіш 66,7% -ға жетті, бұл бақылау көлемінен 2,55 есе артық. Алдағы уақытта эмбриондар белсенділігі төмендеп, сәуір айының соңында нөлге дейін жетті.

Екінші тәжірибеде бірінші тәжірибеден алынған жұмыртқа қолданылды, яғни сол жұмыртқаның шығымы 66,9 % (31. 01) және «көл суы + несеп» (105 г/л) жаңа ерітіндісіне орналастырылды. 19 күннен кейін, бақылаумен салыстырғанда, науплиус шығымы 52,1%-ға өсті және бірінші тәжірибеден 23,7%-ға артты. Алдағы уақытта жоғары деңгей сақталған, бірақ 29. 04. 80,8%-дағы шығу деңгейі кезінде көптеген әлсіреген және өлі науплиус саны байқалды.

Үшінші тәжірибеде 233 г/л минералданған және 36,7% өскен көлден алынған көктемгі жұмыртқа қолданылды. Көл суын (233 г/л) несеп және тұщы сумен араластыру есебінен тұздың түрлі концентрациясы (110-140 г/л) пайдаланылды. Активтендірудің ұзақтығы 20 және 30 күнге созылды. Ерітіндіні 110 г/л минералдап, белсендірілген кезде науплиус шығымы өсті және бір айдан кейін бақылаудан 1,65 есе асып түсті. Тәжірибе соңында тұз концентрациясының артуы науплиус шығымын төмендетіп, белсендіруші әсерді баяулатты. Ерітіндіні тұщы сумен араластыру ерітіндінің әсер ету тиімділігін төмендетті, ал жоғары араласқанда эмбриондардың толық жойылғаны байқалды.

Ұсынылатын сұйықтық компоненттерінің белсендіретін әсер ету механизмдері стероидты гормон метаболиттерінің жұмыртқада личинканың қалыптасуына физиологиялық ықпалы әрі жұмыртқа қабығына бірқатар заттардың деструктивті физикалық-химиялық әсері бар. Бүйрек үсті без қабығы гормондарының (минералокортикоид және глюкокортикоид), сондай-ақ адам мен жануар несепіндегі жыныс гормондарының метаболиттері тіндегі алмасу үдерісін күшейтетіндіктен, кез келген жануар эмбрионының дамуына белсенді әсер етуі мүмкін. Несеп компоненттерінің жұмыртқа қабығына деструктивті әсері, науплиус шығымын жеңілдетеді әрі липидтерді ішінара шаю, ақуыз құрылымы мен гидролиздің бұзылуы, ұлпаны ажырату әсері бар. Карбамид және басқа да органикалық заттар – несептегі электролитті емес тұз иондарының антагонисі болып есептеледі және жұмыртқа қабығының ісінуіне ықпал етеді.

Несеп нәрмен ішінара гидролизденген ақуыздар, сондай-ақ су, қабық деструкциясының жалпы үдерісін жылдамдатады. Жұмыртқа қабығы ісінгенде заттардың қабық ішіне ену тәртібі маңызды рөл атқарады. Алдымен несепте нәр әсерінен қабықтың ішінара деструкциясы пайда болады, содан кейін концентрация градиенті бойынша ішке жылжымалы натрий иондары кіреді, содан кейін несептегі органикалық заттар (карбамид, басқа аз мөлшердегі алмасу өнімдері, стероидтар) енеді. Натрий катиондары гидрат қабығына еніп, су өткізбейтін қасиеттерге ие болады. Стероидты гормон метаболиттері қабық ішіне еніп, натрий катиондарын (минералокортикоидтар) ұстап қалады, демек, сұйықтықтың жиналуына ықпал етеді, себебі бір валентті катиондар тірі тінге гидрат жасайтын қасиеттерге ие. Жұмыртқа қабығының деструкциясы оттегінің ішіне енуіне ықпал етеді, ол да науплиус дамуын ынталандырады.

Жұмыртқа қабығының деструкциясы бар эмбрионның дамуын осындай кешенді белсендіруде науплиустардың қоректік құндылығын сақтай отырып, жұмыртқаның пластикалық және энергетикалық субстанцияларын үнемдейді.

Түйін сөздер: артемия, жұмыртқа, қабық, науплиустардың шығуы, несеп.

А.В. Убаськин^{1,2}, Н.Е. Тарасовская³, К.И. Ахметов¹, А.И. Луньков²

¹Торайгыров университет, Павлодар, Казахстан;

² ТОО «Экологический Центр Прииртышья», Павлодар, Казахстан;

³Павлодарский государственный педагогический университет, Павлодар, Казахстан;

К ПРОБЛЕМЕ ИСПОЛЬЗОВАНИЯ ЕСТЕСТВЕННЫХ БИОЛОГИЧЕСКИ АКТИВНЫХ ВЕЩЕСТВ ДЛЯ АКТИВАЦИИ ЯИЦ АРТЕМИИ

Аннотация. В настоящее время жаброногий рачок рода *Artemia* Leach, 1819 является хорошим стартовым кормом при искусственном выращивании молоди гидробионтов. Однако часто наблюдается пониженный выклев науплиусов из собранных яиц и требуется проведение искусственной активации. В результате эмпирических исследований удалось опытным путем обнаружить активирующее действие продуктов выделения – разбавленной урины взрослого человека. Исследования были проведены в несколько этапов.

На первом этапе исследований опытным путем определили величину выклева науплиусов из осенних яиц артемий в период, когда эмбрионы становятся близки к состоянию диапаузы и в весенний период после естественной активации. Установлено, что в среднем темп прироста всхожести для разных популяций колеблется от 0, 2 до 0, 6% в сутки.

Второй этап экспериментальных исследований состоял в активации яиц в жидких средах с различной долей активирующего вещества (урины взрослого человека) и соленой озерной воды.

В первом опыте цисты с выклевом 24% поместили в раствор озерной воды разбавленной уриной до концентрации 105 г/л. Использование свежей урины в растворе активации стимулировало выклев науплиусов артемий, и уже через две недели этот показатель достиг величины 66,7 %, превышая величину контроля в 2,55 раза. В дальнейшем активность эмбрионов начала снижаться, и к концу апреля выклев упал до нуля.

Во втором опыте использовалось яйцо из опыта 1 с выклевом 66,9 % (31.01), помещенное в свежий раствор «озерная вода + урина» (105 г/л). Через 19 дней выклев повысился на 52,1 % по сравнению с контролем и на 23,7 % превысил данные опыта 1. В дальнейшем сохранялся высокий уровень выклева, но 29.04. при выклевом 80,8 % наблюдалось большое число ослабленных и мертвых науплиусов.

В третьем опыте использовалось весеннее яйцо из озера с минерализацией 233 г/л и всхожестью 36,7%. Были использованы различные концентрации солености (110-140 г/л) за счет разбавления озерной воды (233 г/л) уриной и пресной водой. Продолжительность активации составляла 20 и 30 суток. При активации в растворе с минерализацией 110 г/л шел рост выклева и через один месяц превысил контроль в 1,65 раза. Увеличение концентрации соли снизило активирующий эффект с некоторым снижением выклева в конце опытов. Разбавление раствора пресной водой снизило эффективность действия раствора, а при более высоких разбавлениях наблюдалась полная гибель эмбрионов.

Механизмы активирующего действия компонентов предлагаемой жидкости складываются из физиологических влияний метаболитов стероидных гормонов на формирование личинки в яйце и деструктивных физико-химических воздействий ряда веществ на оболочку яйца. Метаболиты гормонов коры надпочечников (минералокортикоидов и глюкокортикоидов), а также половых гормонов, содержащиеся в моче людей и животных, могут оказать активирующее воздействие на развитие эмбриона любого животного за счет усиления обменных процессов в тканях. Деструктивное влияние компонентов урины на оболочку яиц, облегчающее выход науплиусов, заключается в частичном омылении липидов, нарушении структуры и гидролизе белков, мацерующем действии. Карбамид и другие органические вещества-неэлектролиты, содержащиеся в моче, являются антагонистами ионов солей и способствуют набуханию яйцевых оболочек. Белки, частично гидролизованные мочевиной, также присоединяют воду и набухают, ускоряя общий процесс деструкции оболочки. Определенную роль в набухании яйцевых оболочек мог сыграть порядок проникновения веществ внутрь оболочки. По-видимому, сначала происходит частичная деструкция оболочки под действием мочевины, затем внутрь по градиенту концентрации проникают подвижные ионы натрия, и лишь затем – органические вещества, имеющиеся в моче (карбамид, небольшое количество других продуктов обмена, стероиды). Катионы натрия проникают в гидратной оболочке и обладают водоудерживающими свойствами. Метаболиты стероидных гормонов также способствуют набуханию и дальнейшему разрыву яйцевых оболочек за счет того, что, проникая внутрь оболочки, они задерживают катионы натрия (минералокортикоиды), а значит, способствуют накоплению жидкости, поскольку одновалентные катионы обладают для живых тканей гидратирующими свойствами. Деструкция оболочек яйца способствует проникновению внутрь кислорода, который также оказывает стимулирующее воздействие на развитие науплиуса. При такой комплексной активации развития зародыша с деструкцией яйцевых оболочек достигается экономия имеющихся в яйце пластических и энергетических субстанций, сохраняя питательную ценность науплиусов.

Ключевые слова: артемия, яйца, оболочка, выклев науплиусов, урина.

Information about authors:

Ubaskin A. V., candidate of biological sciences, associate professor of department of Biology and Ecology, Toraighyrov University, Lomov str. 64, Pavlodar, Kazakhstan. E-mail: awupawl@mail. Ru, <https://orcid.org/0000-0001-9835-9043>;

Tarasovskaya N. E., professor of department of Education program «Biology», Pavlodar State Pedagogical University, Mira str. 60 Pavlodar, Kazakhstan. <https://orcid.org/0000-0002-6040-6374>;

Akhmetov K. I., master of biology, senior lecturer of department of Biology and Ecology, Toraighyrov University, Lomov str. 64, Pavlodar, Kazakhstan. E-mail: kairat_akhmetov@mail. Ru, <https://orcid.org/0000-0003-3354-4023>;

Lunkov A. I., engineer, Toraighyrov University, Lomov str. 64, Pavlodar, Kazakhstan. E-mail: al67kz@mail. ru, <https://orcid.org/0000-0002-5146-0897>

REFERENCES

[1] Litvinenko L.I., Matveeva E.P., Yaduvankina M.A. (2008) Activation of Artemia cysts as an important component in the Biotechnics of obtaining live starter feed for aquaculture facilities. Freshwater aquaculture: state, trends and prospects of development, Tyumen, Russian Federation. P.72.

[2] Sorgeloos P., Lavens P., Leger Ph., Tackaert W., Versichele D. (1986) Manual for the culture and use of brine shrimp in aquaculture. Chentuniversiteit, Belgium.

[3] Litvinenko L.I., Mamontov Yu.P., Ivanova O.V., Litvinenko A.I., Chebanov M.S. (2000) Instructions for the use of Artemia in aquaculture. SibrybNIIproekt, Russian Federation.

[4] Koichubekov B.K., Sorokina M.A., Bukeeva A.S., Takuadina A.I. (2012) Biostatistics in examples and problems: educational and methodological guide. LLP«Evero», Kazakhstan. ISBN: 978-601-240-194-3

[5] Ubaskin A.V., Akhmetov K.I., Lunkov A.I., Yerzhanov N.T., Abylkhasanov T.Zh., Abylkhasanova A.U. (2020) Experimental research for technological preparation of artemia (*Artemia*) artificial cultivation in salt lakes, Proceedings of the national Academy of Sciences of the Republic of Kazakhstan. Biological and medical series, 2518-1629. DOI:10.32014/2020.2519-1629.15 (in Eng.).

[6] Ubaskin A.V. (2003) Natural sciences and ecology [Estestvennyye nauki i jekologija] 7:164-171 (in Russ.).

[7] Wolf L.A. (2007) The usage of various drugs to activate Artemia's eggs. Chemistry and chemical technology in the XXI century, Tomsk, Russian Federation. P.72.

[8] Golikov A.N., Bazanova N.U., Kozhebekov Z. Kand etc. (1991) Physiology of farm animals. Agropromizdat, USSR. ISBN: 5-10-001154-8

[9] Ryazhenov V.V., Volnova G.I. etc. (1994) Pharmacology. Medicine, Russian Federation. ISBN: 5-225-04768-8

[10] Haggis G., Michie D., Muir A., Roberts K., Walker P. (1974) Introduction to Molecular Biology. Wiley, USA. ISBN: 9780470338742

[11] Yakushkina N.I. (2005) Plant physiology. Vlados, Russian Federation. ISBN: 5-691-01353-X

[12] Glinka N.L. (2020) General chemistry. Urait, Russian Federation. ISBN: 978-5-9916-9672-2

[13] Petrov A.A., Balyan H.V., Troshchenko A.T. (2002) Organic chemistry. Ivan Fedorov, Russian Federation. ISBN: 5-81940-067-4

**REPORTS OF THE NATIONAL ACADEMY OF SCIENCES
OF THE REPUBLIC OF KAZAKHSTAN**

ISSN 2224-5227

<https://doi.org/10.32014/2020.2518-1483.113>

Volume 5, Number 333 (2020), 13 – 18

UDC 61.339.13; 61.659.1;616.9

E.G. Tolokonnikov¹, A.S. Adekenova², O.V. Maslova²¹LLP «Karaganda Pharmaceutical Plant», Karaganda, Kazakhstan;²JSC «International Research and Production Holding «Phytochemistry», Karaganda, Kazakhstan.E-mail: etolokonnikov@krgpharm.kz; info@phyto.kz**PHARMACOECONOMICAL ANALYSIS
OF ANTI-PERIODONTOSIS DRUGS**

Abstract. In this work, a retrospective analysis of anti-periodontosis drugs is carried out using the methods of pharmacoeconomic analysis: analysis of the "cost of disease" (direct costs), "cost-effectiveness" for promoting the original drug "Matripin-Dent" on the pharmaceutical market.

In the clinic of the Dental Institute of Kazakh National Medical University named after S.D. Asfendiyarov (Almaty), clinical trials of a new domestic phytopreparation "Dental gel Matripin-Dent" were carried out. The gel preparation was used in the complex therapy of periodontal diseases of an inflammatory and inflammatory-destructive nature. As a result of the experimental studies, it was found that "Matripin-Dent", due to the original composition of the gel composition, provides high adhesion to mucous surfaces, ensures reliable fixation of the drug on the gums, contributes to a better distribution of active components due to good absorption of the ointment base composition.

It has been proven that the developed dosage form "Matripin-Dent" based on pharmacologically active compounds of *Populus balsamifera* L. buds and flowers, leaves, buds of *Matricaria chamomilla* L. has a number of advantages in comparison with the drugs existing on the pharmaceutical market used in dental practice.

Key words: Parodontosis, Matripin-Dent, "Kamistad", pharmacoeconomics.

Introduction. According to the World Health Organization, published in the annual news-bulletin, the most common dental diseases include caries, periodontitis, congenital and traumatic oral pathologies, diseases of an infectious nature.

To date, the pharmaceutical market is represented by a fairly wide range of therapeutic and prophylactic agents used for the treatment and prevention of periodontitis, containing extracts of medicinal plants as active ingredients. The main active ingredients in therapeutic and prophylactic agents used in dental practice are biologically active substances of medicinal plants: *Matricaria chamomilla* L., *Potentilla erecta* (L.) Hampe., *Hypericum perforatum* L., *Achillea millefolium* L., *Salvia officinalis* L., *Acorus calamus* L., *Arnica*, *Mentha piperita* L., *Eucalyptus viminalis* Labill. Based on the results of studying the chemical composition and pharmacological properties of medicinal plants, there is a unique opportunity to use plant substances as an active ingredient in the development of the composition and technology of new drugs used for the treatment and prevention of infectious and inflammatory diseases of the oral mucosa [1-2].

Numerous studies have shown that the introduction of plant extracts into the composition of dosage forms can increase the effectiveness of therapy for various inflammatory diseases of the gums, especially of an infectious nature. In this regard, the development of new, more effective and safe agents for the treatment of this disease is urgent.

In dental practice, the following pharmacopoeial preparations based on plant raw materials are used with great efficiency: maraslavin, sangviritrin (liniment, alcohol and water solutions), novoimaninum, chlorophyllipt and others [3-4].

Globally, 70-90% of school-age children and 95-99% of the adult population have caries. Severe periodontitis is found in 20% of people aged 35 to 45 years. Globally, 30% of elderly people aged 65 and over have a complete absence of natural teeth. The prevalence of dental pathologies is higher and tends to increase among populations from disadvantaged groups and in countries with a low level of living.

For the treatment of inflammatory periodontal diseases, antioxidants and antihypoxants (mexidol, vitamins of group E and others) are actively used, which have a wide range of therapeutic action, low toxicity, increasing the adaptive capabilities of the body, including compensatory ways of maintaining peripheral homeostasis. These preparations have anti-inflammatory and anti-edematous effects, enhance the regeneration processes.

The possibilities of using drugs based on plant substances for the treatment of dental diseases are very relevant. In the modern pharmaceutical industry, there is a wide range of medicinal preparations from plant raw materials used for diseases of the oral cavity, however, the treatment of periodontal diseases is largely empirical in nature, due to the lack of convincing evidence of the advisability of using certain drugs in the treatment of periodontal diseases. Therefore, the development of anti-parodontosis drugs based on plant raw materials that meet modern requirements for proper manufacturing practice is a promising direction.

Pharmacologically active compounds of poplar species (*Populus* L.) are a promising source for obtaining antimicrobial, anti-inflammatory and wound-healing drugs [5].

A significant role in the development of the inflammatory process in the parodontosis is played by the microbial factor. Complex therapy should also provide a specificity of the effect of drugs on a specific type of microorganism. A high level of inflammatory periodontal diseases (IPD) is observed at the age of 20-44 (65-95%) and 15-19 years (55-89%) [6-13].

Therefore, the developed drug "Matripin-Dent" based on the plant substances of *Populus balsamifera* L. and *Matricaria chamomilla* L. has a number of advantages in comparison with the drugs existing on the pharmaceutical market used in dental practice [14].

Firstly, the drug "Matripin-Dent" allows you to expand the range of complex phytopreparations for the treatment of inflammatory diseases of the oral mucosa, get rid of the purchase of expensive imported drugs of similar pharmacological action. Secondly, it shortens the treatment time for patients.

A positive aspect when creating a gel dosage form is the provision of a pharmacological action due to the presence of a combined effect of the extracts of biologically active substances, which affects technological factors such as the accuracy of dosing, the constancy of the concentration of biologically active substances for a long time, strong fixation to damaged tissues of the oral mucosa.

The aim of the study: to carry out a pharmacoeconomical analysis of the use of anti-parodontosis drugs using the analysis of "cost of disease" and "cost-effectiveness".

Materials and methods: A retrospective analytical review was carried out using the methods of pharmacoeconomical analysis: analysis of the "cost of disease" (direct costs), "cost-effectiveness" with the definition of competitive advantages, life cycle, target audience, ultimate consumer, links of strong and weak influence on the marketing promotion of the drug on the pharmaceutical market. SWOT analysis of drug, Sell-in, Sell-out analysis, Porter's Five Forces methodology, which allows to visually consider the market in a competitive environment.

Study results.

In the clinic of the Dental Institute of Kazakh National Medical University named after S.D. Asfendiyarov (Almaty), clinical studies of a new domestic phytopreparation "Dental gel Matripin-Dent" were carried out. The gel preparation was used in the complex therapy of periodontal diseases of an inflammatory and inflammatory-destructive nature.

As a result of experimental and clinical studies, it was found that "Matripin-Dent", due to the original composition of the gel composition, provides high adhesion to mucous surfaces, ensures reliable fixation of the drug on the gums, promotes a better distribution of active components due to the good absorption of the ointment base composition.

The results obtained indicate the effectiveness of the drug in a complex of therapeutic measures in the treatment of gingivitis and parodontosis.

Based on the processed data and information on the state of the pharmacological market in Kazakhstan and the countries of the Eurasian Economic Union (EAEU), the following conclusions can be drawn - at the moment is the most favorable time for the development and launch of drugs on the market. The policy of the EAEU countries is aimed at creating a self-sufficient pharmaceutical industry, ousting imported drugs from the market and increasing healthcare costs. The state policy of countries and market participants is facing strong resistance from importing companies with strong market positions and possibly a strong lobby in the government (for example, the Russian Federation).

The economic impact on the industry is especially noticeable against the background of US and European sanctions. Trade wars and weaknesses in national currencies will slow down the development of national industries in every possible way. Do not discount the fact that Russia makes up 85% of the population and economy of the EAEU. The creation of a single market and the ousting of foreign suppliers will be beneficial first of all to Russia; it is quite expected that Russian companies will seize national markets in the near future. It is not excluded that the market in five to seven years will have a similar structure as now, but 75-90% of the products will be imported not from India or Europe, but from Russia.

Difficulties with the protection of intellectual property, the weak efficiency of the courts of the EAEU countries calls into question the development of original drugs. Pharmaceutical companies prefer to develop the generics niche. Unfortunately, this is a dead-end branch of development, which may contribute to the achievement of financial goals of manufacturers in the short term, but will not contribute to improving public health in the long term.

Given the described situation, it is assumed that the current economic situation and the policies undertaken by the EAEU member states in the long term will contribute to the development of national industries and the displacement of imported products.

According to BMI Research forecasts, the pharmaceutical market will grow and reach a volume of USD 1.55 billion in 2018. Going forward, growth will continue with an average (CAGR) of 14%, doubling by 2022.

In 2017, as a whole in the Eurasian Economic Union, there was a positive trend in industrial production, agricultural production, freight turnover, passenger turnover, retail trade, volumes of foreign and mutual trade.

There was an increase in industrial production in all the EAEU member states, agricultural production - in Belarus (by 4.1%), Kazakhstan (by 2.9%), Kyrgyzstan (by 2.2%) and Russia (by 2.4%). %, the volume of construction work performed - in Armenia (by 37.7%), Kazakhstan (by 1.9%), cargo turnover, passenger turnover, retail trade turnover - in all EAEU member states.

The index of the physical volume of the gross domestic product in the EAEU in January - September 2017 compared to January - September 2016 amounted to 101.9% (in January - September 2016 compared to January - September - 2015 - 99.6%).

With a population of 6.1 million, the market is one of the smallest in the region - Tajikistan (8.9 million), Azerbaijan (9.8 million) and Kazakhstan (18.2 million). In addition, the rural population predominates; only 36.1% live in urban areas, which is one of the lowest rates in the entire region. Market size is only 246 million USD and 41 USD per capita. Kyrgyzstan is one of the smallest and least developed pharmaceutical markets in the Central Asia region. Pharmaceutical sales in 2017 amounted to 3.3% of GDP and 54.0% of total healthcare spending. While data on the size of market sectors are not currently available, limited purchasing power of the population, combined with a high dependence on cash payments, leads to the fact that the demand for drugs is almost exclusively for generic drugs (mainly non-brand) and OTC drugs.

The Porter's Five Forces methodology was used to analyze the dental market. Breakdown of the competitive environment into five components allows you to visually examine the market.

Competitors, international conglomerates with powerful sales and marketing divisions that hold the overwhelming market share have the greatest influence on the market. Despite the large potential audience, population growth is limited. Supplier influence and entry of new players is seen as limited.

Direct drug competitors are plant-based products.

We managed to obtain reliable sales data on "Kamistad-gel", manufactured by "Stada".

According to the "MedElement" company, as of January 30, 2018, 3,970 pharmacies function in large cities of Kazakhstan (excluding pharmacy points in state medical institutions).

The largest number of pharmacies is in Almaty - 870. Also, in the top three in terms of the number of pharmacies are in Nur-Sultan and Shymkent - 442 pharmacies. Among the three outsiders are Taraz, Kokshetau, Temirtau - 69, 59, 57 pharmacies, respectively.

According to news-bulletin of World Health Organization №318 dated May 2012, severe paradontosis (gum disease), which can lead to tooth loss, is found in 15-20% of middle-aged people (35-44 years), while worldwide 60-90% of school-age children and almost 100% of adults have dental caries or other oral diseases.

According to BMI Research data, Kazakhstan's population was 17.7 million in 2018, with an average growth of 1.3% through 2025.

For a more accurate calculation of the target audience, the urban population of the Republic of Kazakhstan was taken into account.

Given the prevalence of diseases, it can be concluded that the risk group (35-44 years) will be 156 thousand people in 2020 and will double to 323 thousand by 2025. School-age children currently (according to 2015 data) are 1.5 million children, and will increase to 2.2 million in 2025.

The target audience is estimated at 1.4 million in 2020 and 2.5 million in 2025. The maximum possible target audience will be 5.9 million people in 2020 and 8.4 million people in 2025.

The analysis of Sell-in, Sell-out and calculations allow us to conclude that the vast majority of retail chains have a stock of 6% in their own warehouses. It can be assumed that "Metrogyl" almost never stays on the shelves, and is almost entirely sold by pharmacy chains. The only exceptions are some regions of the country. Perhaps this is due to the fact that pharmacy chains sold drugs from their stocks and did not purchase new ones.

The target audience of the drug is divided into two large groups, B2B sector and patients.

B2B sector - health-promoting institutions, dental clinics and dental rooms, as well as pharmacy chains.

Patients - risk groups (35-44 years old), school-age children.

To calculate marketing costs and tools, the experience of the Russian market was taken as an example.

Pharmaceutical companies increased their TV advertising expenses in 2016, increasing the share of expenses to 90%. Some companies have sharply increased their expenses in the regions. According to the assessment of Media Direction Group (part of the BBDO group), which also monitors the pharmaceutical segment of the advertising market, STADA CIS increased its advertising costs on regional television more than 20 times in 2016.

Based on the experience of Russian colleagues described above, it seems rational to focus on television advertising. Comparing the volume of advertising budgets of the largest companies in Russia and their range of drugs, the following conclusions can be drawn using the example of PJSC "OTCPharm". In 2016, the company spent 3.359 million rubles on advertising to advertise 145 names of drugs 23.17 million rubles or 115 million tenge were spent on advertising one drug in year.

The sales plan is based on the following assumptions:

- Proven annual market volume of 470 thousand tubes per year.
- The minimum required market capture of 16% (181 thousand tubes per year) is needed from the requirements to maintain a break-even point of 174 thousand tubes.
- This section presents the minimum required production volume, in the sensitivity analysis section, financial indicators are indicated taking into account different productivity.

It should be especially noted that the original drug "Matripin-Dent" requires regular use, which will help to maintain demand. Market size of 470 thousand tubes per year is proven and only reflects a known part of the market.

Treatment of the disease with the use of gels is temporary; complete cure of parodontosis without medical intervention is unlikely. Regular use of soft dosage forms is essential to prevent the development and spread of the disease. In this regard, the patient will need to regularly purchase the drug "Matripin-Dent".

In the first years of production, the level will be 180 thousand tubes per year, occupying 16% of the market. In 2027, the market capture will reach 20% and will amount to 234 thousand tubes. Starting from 2029, the occupied share will be 30% and will be equivalent to 358 thousand tubes. It is assumed that the market size will grow by 1% annually, which corresponds to natural population growth. By 2048, the volume will reach 432 thousand per year.

These assumptions are based on the fact that the real market size can be 1,070 thousand tubes per year, given that there are 8 competitor drugs on the market.

Conclusions.

The results of clinical studies and pharmacological indicators of a new drug indicate the correctness of the chosen path to create a comparatively competitive drug. The drug "Matripin-Dent" with a high

degree of probability by the end of all stages of testing will confirm its characteristics and will be able to surpass the currently available competing drugs.

Understanding the environment and business activities of competitors, one can conclude that the original drug is promising and has every chance of achieving commercial success. At the same time, the success of the domestic drug "Matripin-Dent" will largely be determined by the chosen development strategy. The optimal strategy for its promotion will allow you to realize the full potential of the market and minimize risks.

Е.Г. Толоконников¹, А.С. Әдекенова², О.В. Маслова²

¹«Қарағанды фармацевтикалық зауыты» ЖШС, Қарағанды, Қазақстан;

²«Фитохимия» халықаралық ғылыми-өндірістік холдингі» АҚ, Қарағанды, Қазақстан

ПАРОДОНТОЗҒА ҚАРСЫ ПРЕПАРАТТАРДЫ ФАРМАКОЭКОНОМИКАЛЫҚ ТАЛДАУ

Аннотация. Жұмыста бірегей «Матрипин-Дент» препаратын фармацевтикалық нарыққа шығару үшін «аурудың құны» (тікелей шығын), «шығын-тиімділік» фармакоэкономикалық талдау әдістерін қолдана отырып, пародонтозға қарсы дәрілік құралдарға ретроспективті талдау жүргізілді.

С.Ж. Асфендияров атындағы ҚазҰМУ-дың стоматология институты клиникасында (Алматы қ.) жаңа отандық «Матрипин-Дент (Matripin-Dent) стоматологиялық гелі» фитопрепаратына клиникалық сынақ жүргізілді. Гельдік препарат қабыну және қабыну-деструктивті сипаттағы пародонт ауруларының кешенді терапиясында қолданылды. Жүргізілген эксперименттік зерттеу нәтижесінде «Матрипин-Дент» гельдік композицияның бірегей құрамының арқасында шырышты беттерге жоғары адгезияны және дәрілік құралдың қызыл иекке сенімді бекітілуін қамтамасыз ететіні, бұған қоса жақпамай композициясының жақсы сіңуінің арқасында әсер етуші компоненттердің жақсы таралуына ықпал ететіні анықталды.

Бальзамды терек бүршігі мен дәрілік түймедақ гүлі, жапырағы, гүлшанақтарының фармакологиялық белсенді қосылыстары негізінде жасалған «Матрипин-Дент» дәрілік түрі стоматологиялық тәжірибеде қолданылатын фармацевтикалық нарықтағы дәрі-дәрмектермен салыстырғанда бірқатар артықшылығы бар екендігі дәлелденді.

Түйін сөздер: пародонтоз, Матрипин-Дент, «Камистад», фармакоэкономика.

Е.Г. Толоконников¹, А.С. Адекенова², О.В. Маслова²

¹ТОО «Карагандинский фармацевтический завод», Караганда, Казахстан;

²АО «Международный научно-производственный холдинг «Фитохимия», Караганда, Казахстан

ФАРМАКОЭКОНОМИЧЕСКИЙ АНАЛИЗ ПРОТИВОПАРОДОНТОЗНЫХ ПРЕПАРАТОВ

Аннотация. В данной работе проведен ретроспективный анализ противопародонтозных лекарственных средств с использованием методов фармакоэкономического анализа: анализ «стоимость болезни» (прямые затраты), «затраты-эффективность» для продвижения на фармацевтический рынок оригинального препарата «Матрипин-Дент».

В клинике стоматологического института КазНМУ им. С.Д. Асфендиярова (г. Алматы) проводились клинические испытания нового отечественного фитопрепарата «Стоматологический гель Матрипин-Дент (Matripin-Dent)». Гелевый препарат использовали в комплексной терапии заболеваний пародонта воспалительно-деструктивного характера. В результате проведенных экспериментальных исследований, было установлено, что «Матрипин-Дент», благодаря оригинальному составу гелевой композиции, обеспечивает высокую адгезию к слизистым поверхностям, обеспечивает надежную фиксацию лекарственного средства на деснах,

способствует лучшему распределению действующих компонентов благодаря хорошей всасываемости основы мазевой композиции.

Доказано, что разработанная лекарственная форма «Матрипин-Дент» на основе фармакологически активных соединений почек тополя бальзамического и цветов, листьев, бутонов ромашки аптечной имеет ряд преимуществ в сравнении с существующими на фармацевтическом рынке средствами, применяемыми в стоматологической практике.

Ключевые слова: пародонтоз, Матрипин-Дент, «Камистад», фармакоэкономика.

Information about authors:

Tolokonnikov E.G., Doctor of Pharmaceutical Sciences, LLP «Karaganda Pharmaceutical Plant», e-mail etolokonnikov@krghpharm.kz, <https://orcid.org/0000-0002-0098-6098>;

Aizhan S. Adekenova, LLP «Karaganda Pharmaceutical Plant, e-mail - adekenova@gmail.com, <https://orcid.org/0000-0002-1886-5606>;

Maslova O.V., JSC «International Research and Production Holding «Phytochemistry», e-mail - info@phyto.kz, <https://orcid.org/0000-0001-8601-0098>

REFERENCES

- [1] Banchenko G.V., Fleysher G.M. Lekarstvennyye rasteniya v stomatologii. Stomatologicheskii travnik. 2017. 210 p. (In Russian).
- [2] Fleysher G.M. Fitoterapiya v stomatologii. 2017. 290 p. (In Russian).
- [3] Goncharova E.I. Preparaty lekarstvennykh rasteniy v lechenii zabolevaniy slizistoy obolochki rta // Rossiyskiy stomatologicheskii zhurnal. 2015. Vol.19. №4. P. 55–57. (In Russian).
- [4] Mashkovskiy M.D. Lekarstvennyye sredstva. Moskva: Novaya volna, 2007. 1216 p. (In Russian).
- [5] Polyakov V.V., Adekenov S.M. Biologicheski aktivnyye soedineniya rasteniy roda Populus L. i preparaty na ikh osnove. Almaty: Nauka, 1999. 158p. (In Russian).
- [6] Nikitina N.V., Stepanyuk S.N., Klishina I.I., Makarova A.N. Osobennosti razrabotki i analiza mazi s dvukhfaznym ekstraktom pochek topolya chernogo // Zdorov'e i obrazovaniye v XXI Veke. 2011. Vol.13, №12. P. 587-588. (In Russian).
- [7] Tarasova Yu. G., Redinova T. L. Degree based on clinical parameters and quality of life in patients with chronic generalized periodontitis in the Udmurt Republic // Periodontics. 2012. Vol 62, № 1. P. 73-78. (In English).
- [8] Blashkova S.L., Mustafin I.G., Khaliullina G.R. Diagnostic criteria of risk of development of inflammatory periodontal diseases in individuals undergoin orthodontic treatment gingivitis // Periodontics. 2015. Vol 63, №2. P.9-12. (In English).
- [9] Giljarov E.M., Levin N.M. Breach of oral hygiene as a risk factor hypertrophic gingivitis in pregnant women // The postgraduate Bulletin of the Volga region. 2014. № 1-2. P. 193-197. (In English).
- [10] Silin A.V., Kirsanov E.V., Medvedev E.Yu. Influence of initial periodontal status on the choice of the plan of orthodontic treatment in adult patients with dentofacial anomalies // Institute of dentistry. 2011. Vol. 53, №6. P.37-38. (In English).
- [11] Soldatova O.Y., Bulgakova A. I., Ganceva H.H., Khismatullina R.F. Study of the effect of Smoking on indicators of dental health and the relationship of the number of emitted carbon monoxide to Smoking history // Periodontics. 2016. Vol.78, №1. P.26-29. (In English).
- [12] Trunin D. A., Kirillov V. P. Microbial factor in the treatment of periodontitis. // In book: «Actual problems of dentistry», Etching. 2011. P. 345-347. (In English).
- [13] Krechina E.K. Sovremenny podkhod k otsenke pokazateley mikrogedinamiki v tkanyakh parodonta // Stomatologiya. 2017. №1. P. 28-32. (In Russian).
- [14] Patent RK № 32653 ot 15.01.2018g. «Protivoparodontoznoe sredstvo». Zayavl.23.05.2016g.- Opubl. Byul. № 6, 12.02.2018g. / Adekenov S.M., Zhabayeva A.N., Itzhanova Kh.I., Titova N.G. (In Russian).

UDC 678.03:546.26; 677.4

ISRSTI 61.67.33

B.T. Yermagambet^{1,2}, M.K. Kazankapova¹, Zh.M. Kassenova^{1,2}, A.T. Nauryzbayeva¹¹“Institute of Coal Chemistry and Technology” LLP, Nur-Sultan, Kazakhstan;²“KazTechCoal” Scientific and Production Association” LLP, Nur-Sultan, Kazakhstan.

E-mail: coaltech@bk.ru, maira_1986@mail.ru, asemai_2296@mail.ru, zhanar_k_68@mail.ru

SYNTHESIS OF NANOCOMPOSITE FIBERS BASED ON ROCK PITCH AND NANOIRON BY ELECTROSPINNING

Abstract. The article presents experiments on the production of nanocomposite fibers based on the Shubarkol coal tar pitch and nano-iron by the method of electrospinning in a laboratory setup. The elemental composition was determined and the surface morphology of the test sample was studied. As a result of energy dispersive X-ray spectroscopy and SEM microscopy, the elemental composition was determined: C-92.14%, O-6.16%, Al-0.30%, Si-0.26%, P-0.07%, S -0.20%, Cl -0.40%, Fe-0.47% and the diameter of the carbon nanofiber, which ranged from 94.2 nm to 800.0 nm. The results of IR spectroscopy showed an increase in the intensity of the peaks in the region of 2920-2850 cm⁻¹ and the appearance of a signal at 2359 cm⁻¹, which is explained by the breaking of several chemical bonds in the sample structure and the formation of a composite with nano-iron.

Key words: coal tar, nano-iron, nanocomposite fibers, electrospinning, formation, oxidation, carbonization.

Introduction. Carbon nanofibers (CNFs), as one of the most important representatives of carbon materials, have been investigated both in fundamental scientific research and practical applications [1]. CNFs are a class of such materials in which bent graphene layers or nanocones are folded in the form of a quasi-one-dimensional filament, and the internal structure can be characterized by the angle α between graphene layers and the fiber axis [2].

Composite materials often consist of a polymer, metal, carbon or carbide matrix reinforced with fillers of high-strength, high-modulus fibers or whiskers. By varying the composition of the matrix and filler, their ratio, orientation of the filler, a wide range of materials with the required set of properties is obtained. The use of composites usually reduces the weight of the structure while maintaining or improving its mechanical characteristics.

The achievements of recent years in the chemistry of carbon open up very broad prospects for obtaining a composition based on carbon-containing raw materials. Due to their unique properties, extremely high chemical resistance, thermal strength, heat resistance and specific strength, carbon composites have found application as materials for the manufacture of high-temperature technology [3, 4].

By their structure, composites are divided into several main classes: fibrous, dispersion-strengthened, particle-strengthened, and nanocomposites. A low content of filler in composites leads to the appearance of qualitatively new mechanical properties of the material. The material properties can also be varied widely by changing the orientation of the size and concentration of the fibers. In addition, fiber reinforcement gives the material anisotropic properties, and by adding conductor fibers, it is possible to impart electrical conductivity to the material along a given axis.

The microstructure of the remaining classes of composite materials is characterized by the fact that the matrix is filled with particles of a reinforcing substance, and they differ in particle size. In composites reinforced with particles, their size is more than 1 μm , and the content is 20-25% (by volume), while dispersion-strengthened composites include from 1 to 15% (by volume) of particles with a size of 0.01 to 0.1 μm . The sizes of particles included in the composition of nanocomposites - a new class of composite materials - are even smaller and amount to 10-100 nm [5].

CNVs have attracted much attention of scientists for their potential thermal, electrical, shielding and mechanical properties [6]. Due to their exceptional properties and low cost, they are now increasingly used in various materials such as composites.

CNF-based composites can be used as promising materials in many fields, such as electrical devices, electrode materials for batteries and supercapacitors, and also as sensors.

Coal tar (CT), which are formed during the pyrolysis of raw materials, has the following characteristics: density at 20 °C - 1070 kg / m³, viscosity at 80 °C - 2.9-3.3 conventional degrees, coking capacity - 2.0-3, 5%, flash point - 110-120 °C, softening temperature - 60-70 °C, volatile matter yield - 83.0%. It is not electrically conductive and insoluble in water, dissolves only in organic solvents (pyridine, benzene, etc.), and is resistant to acids.

The technology for producing carbon fiber based on coal tar includes several stages: substrate preparation, fiber synthesis by electrospinning, stabilization in an oxidizing atmosphere, carbonization in an inert atmosphere, graphitization at elevated temperatures.

Electrospinning is a versatile and efficient method of producing continuous nanofibers from submicron to nanometer diameters using a high potential electric field. The technology can be easily used in the laboratory and can be scaled up to an industrial process. Electroconversion of nanofibers from polymer solutions or melts is of practical interest, since they have many potential applications [7]. Electrospinning is a process that leads to the formation of nanofibers as a result of the action of electrostatic forces on an electrically charged flow of a solution or melt [8].

Research methodology. Samples of composite CNFs were obtained at the “Institute of Coal Chemistry and Technology” LLP (Nur-Sultan) by electrospinning in laboratory conditions. Coal tar from the coal of the “Shubarkol” deposit and iron nanopowders obtained by the electroexplosive method, which have a size from 70 nm to 150 nm, were used as a raw material.

To prepare raw materials and obtain carbon nanocomposite fibers, the following devices were used: an ultrasonic bath, a laboratory electrospinning unit, a scanning electron microscope (SEM) with an attachment for energy dispersive analysis from EDAX, transmission electron microscopy (TEM) JEM1400 PLUS, and Nicoletis 10 FT-IR spectrometer.

In the study, the electrospinning method was used to obtain nanocomposite fibers in laboratory conditions, since this method, unlike the usual mechanical pulling of fibers from solution, does not impose high requirements on the chemistry of the process, does not require high temperatures for fiber solidification, which means that it allows creating fibers of long and complex molecules. Despite the complexity of the physical processes of electrospinning, this method is distinguished by its instrumental simplicity, high energy efficiency of production, wide versatility for the formed materials, and flexibility in controlling the process parameters. All this makes the electrospinning process attractive for the industrial production of nanofibers [9].

The method of obtaining carbon nanocomposite fibers from coal tar by the electrospinning method includes the following stages: preparation of raw materials, formation, stabilization (oxidation - to remove low molecular weight products of destruction and the formation of crosslinked and cyclic structures) and carbonization (to remove hydrogen and heteroatoms in the form of volatile compounds, where final formation of carbon fibers). To obtain carbon nanocomposite fibers (d = 94.2-800 nm), coal tar and iron nanopowder are used, and polymethyl methacrylate is used as a binder, 1,2-dichloroethane is used as a solvent, the mixture of starting products is subjected to dispersion in an ultrasonic bath at a temperature of 35 °C, frequency - 35 kHz, holding time 30 min, the prepared solution is placed in an electrospinning installation with a syringe, the set voltage is 20-25 kV, the distance between the syringe receiver is 20-30 cm, the fibers obtained after spinning are oxidized at a temperature of 300 °C in the flow air, the holding time is 1 hour, after oxidation, the carbonization process is carried out in an inert argon atmosphere at a temperature of 800 °C, the heating rate is 5 °C / min, the holding time is 60 minutes [9-10].

Results and its discussion. The elemental composition of the original nanocomposite fiber, oxidized and carbonized forms, are presented in table 1.

Table 1 - Elemental composition of samples

№	Name	Content of elements, wt. %										
		C	O	Na	Mg	Al	Si	P	Fe	S	Cl	Ca
1	CNF based on nano-iron and CT	92.14	6.16	-	-	0.30	0.26	0.07	0.47	0.20	0.40	-
2	Oxidized CNF based on nano-iron and CT	93.05	6.66	-	-	-	-	-	0.20	0.03	-	0.07
3	Carbonized CNF based on nano-iron and CT	85.88	6.02	0.44	0.21	0.09	0.78	0.13	5.66	0.28	-	0.43

The functional composition of the sample of the initial coal tar "Shubarkol" was investigated using IR spectroscopy during the experiments. Vibrations typical for C = O carbonyl groups, esters (1762 cm^{-1}), amines (3127 cm^{-1}), aliphatic -CH groups ($2900, 2800\text{ cm}^{-1}$), C-C aromatic hydrocarbons (1602 cm^{-1}), high molecular weight polycyclic aromatic compounds ($825, 722\text{ cm}^{-1}$).

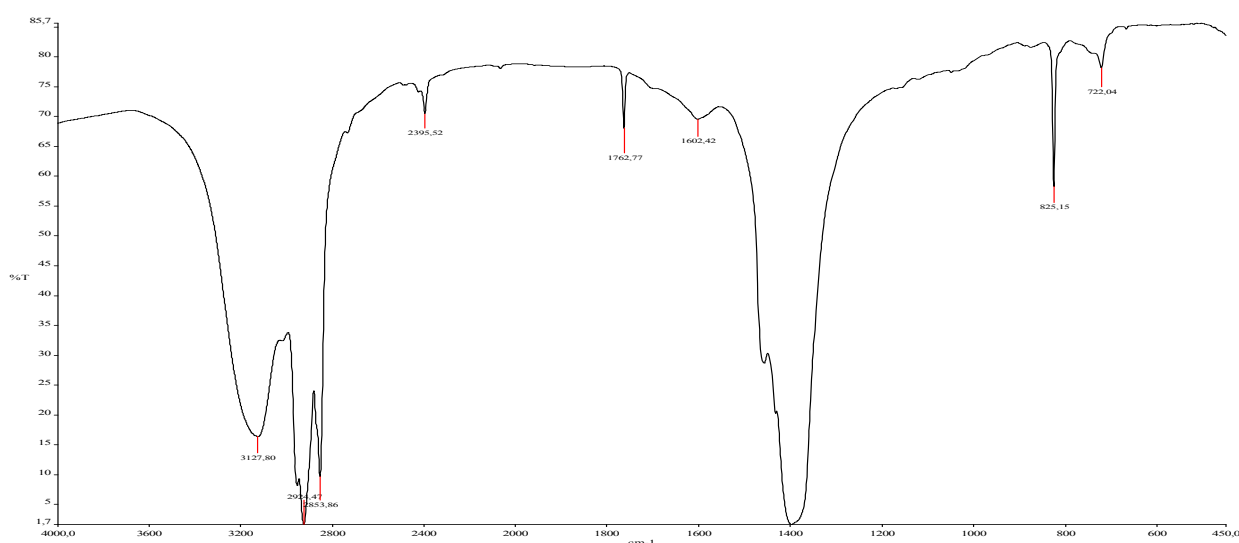

Figure 1- IR spectrum of "Shubarkol" coal tar

SEM and TEM images of a nanocomposite fiber based on CT and nano iron are shown in figures 2 and 3, where carbon nanofibers with a diameter of 94.2 nm to 800 nm are clearly visible. The dimensions and shape of the cross-section of the fibers obtained in the EPI process, as in some other types of dry spinning, are quite clearly interrelated. Fibers less than $1\text{ }\mu\text{m}$ thick have a circular cross-section, however, with increasing thickness, it gradually turns into an oval, and then into a characteristic dumbbell-shaped, showing a tendency for uncured jets of dope to split along the axis.

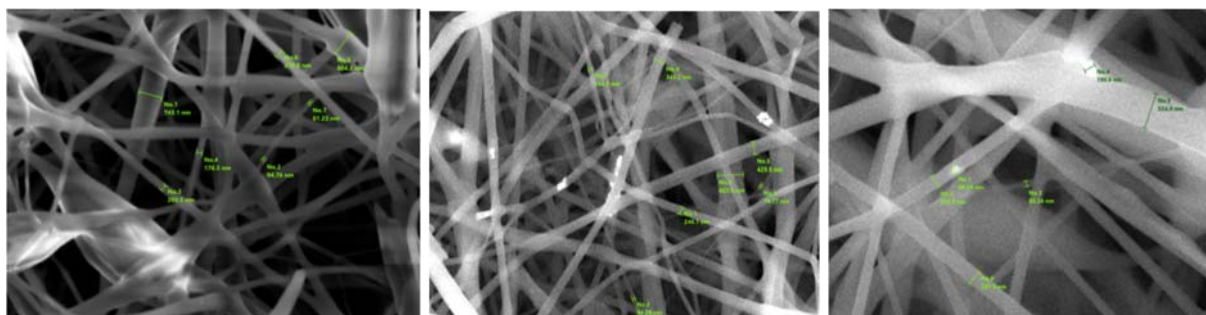

Figure 2 - Electron microscopic images of a nanocomposite fiber based on CT and nano-iron

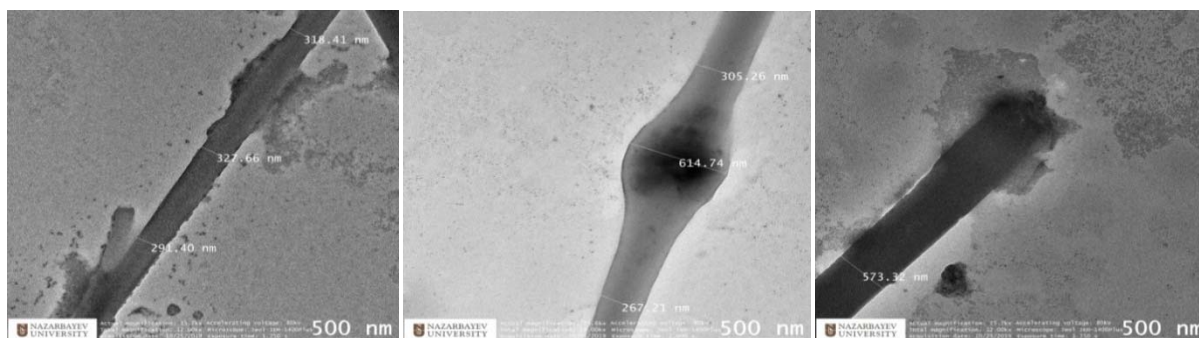

Figure 3 - TEM micrograph of a nanocomposite fiber based on CT and nano-iron

In the IR spectrum of the nanocomposite fiber (figure 4), there is a slight rise in the spectrum in the range $3000-3500\text{ cm}^{-1}$, which refers to weak stretching vibrations of O – H bonds, which may be caused by the presence of moisture. The intensity of the peak in the range from 1260 cm^{-1} – 1275 cm^{-1} decreases; this can be explained by the weakening of the vibrational C – O bond and the 1069 cm^{-1} peak of C – H flexion in the plane. In addition, an increase in the intensity of the peaks in the region of $2920-2850\text{ cm}^{-1}$ and the appearance of a signal at 2359 cm^{-1} are explained by the breaking of several chemical bonds in the sample structure and the formation of a composite iron / polymer nanosphere.

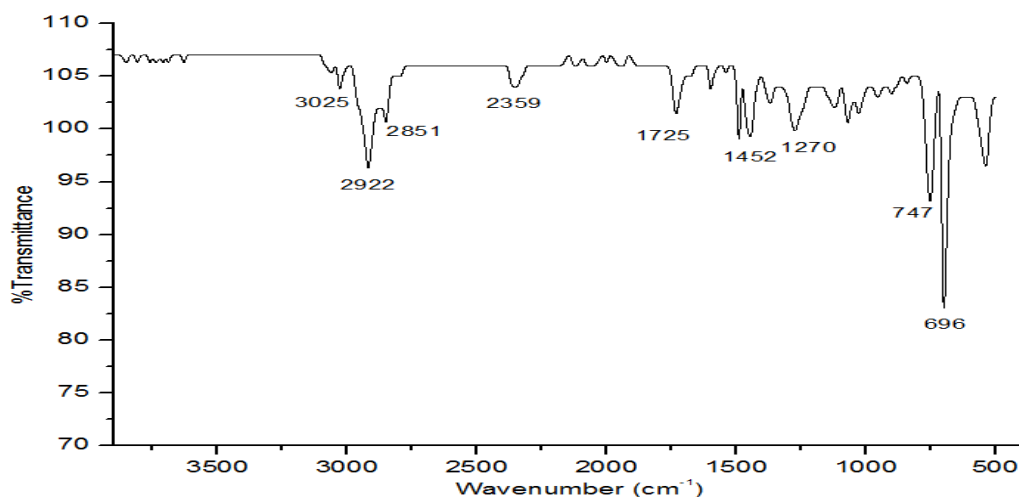

Figure 4 - IR spectrum of a nanocomposite fiber based on CT and nano-iron

Further, we conduct research on the oxidation and carbonization of the obtained CNF, since the spun fiber, as a rule, is characterized by low strength and increased fragility. SEM images of the oxidized form of CNF are shown in figure 5.

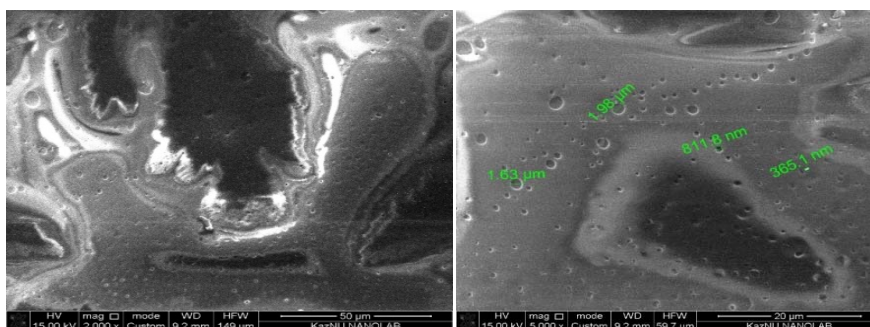

Figure 5 - Electron microscopic images of CNF after oxidation at $300\text{ }^{\circ}\text{C}$

The IR spectra of the oxidized CNF form revealed signals corresponding to the initial sample (figure 6). The absorption bands in the range of wave numbers 3000–3500 cm^{-1} are related to weak stretching vibrations of O – H bonds, probably due to the presence of moisture in this compound.

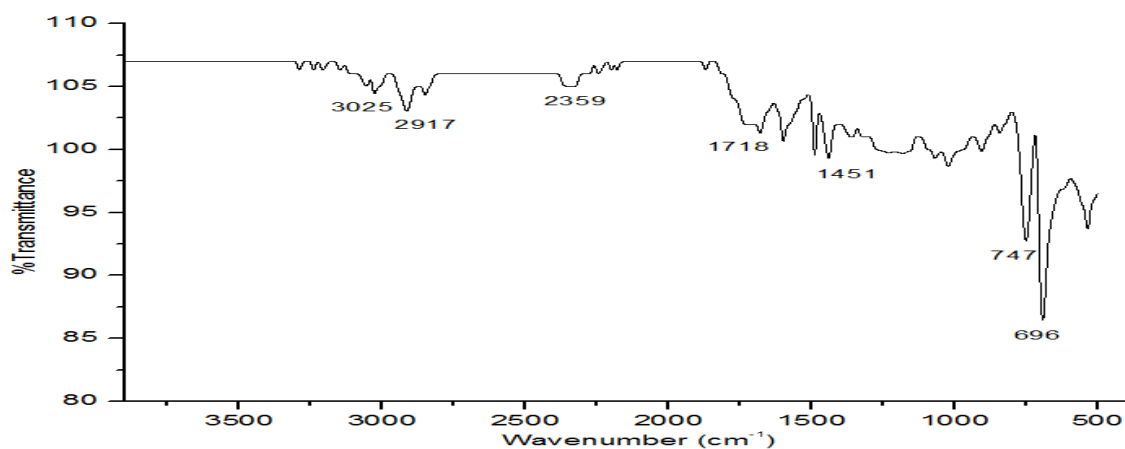

Figure 6 - IR spectrum of the oxidized form of a nanocomposite fiber based on CT and nano-iron

SEM images of the carbonized CNF form are shown in figure 7, where carbon spheres were found with particle sizes from 179.1 nm to 1.08 μm .

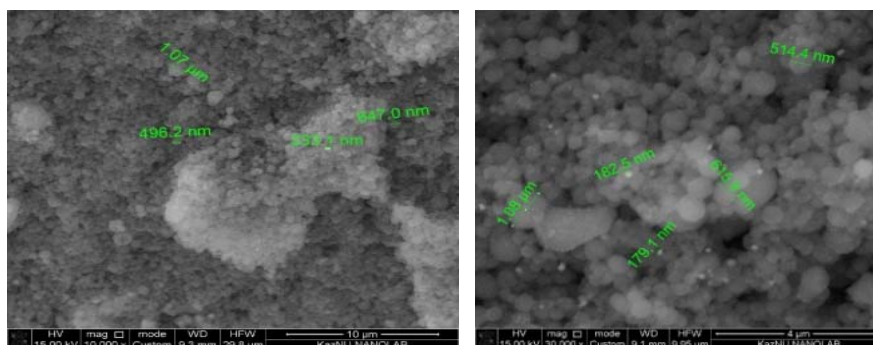

Figure 7 - Electron microscopic images of CNF after carbonization at 800 °C

Thus, as a result of carbonization of CNF, one more product can be obtained - carbon spheres (CS), which have attracted considerable interest among researchers due to their potential application, for example, in gas separation and as molecular sieves, crystals with a photonic band gap, catalyst substrates, and electrode materials for lithium-ion batteries. CSs serve as support substrates due to their high surface area and high structural stability, among other properties. Compared to coal, oil, or derivatives, CSs derived from sustainable, inexpensive raw materials for energy storage have become particularly interesting. The carbonized form of CNF does not give any signal on the FT-IR spectrometer.

Conclusion. Thus, the proposed method for producing composite CNFs is based on the electrospinning method, which is the most promising method of industrial production and provides a product with a relatively high fractional homogeneity, which determines the achievement of the strength characteristics required for structural materials.

The ecological effect of the research consists in the creation of an environmentally friendly technology based on the processing of secondary raw materials (coal tar and other waste from coal mining) to obtain carbon fibers and composites based on them. The creation of this technology will make it possible to solve the ecological aspect of the disposal of this type of waste with the receipt of an economically viable product.

The proposed method is unique in that the raw material that we use to obtain carbon fibers is a renewable resource, in comparison with the technology for producing fibers from many other precursors

(nylon, polyester, acrylic, polypropylene, etc.). The prospect of these studies lies in the possibility of large-scale production of carbon fibers from coal tar, which will lead to the appearance of domestically produced materials and composites based on them on the Kazakhstan market.

Acknowledgement. This work was carried out as part of the scientific and technical program No. IRN BR05236359 “Scientific and technological support for coal processing and production of high-value coal products” and project No. IRN AP05130707 on the theme “Development of technology and creation of production of carbon nanocomposite materials based on domestic mineral raw materials for gas phase purification and wastewater”, funded by the Science Committee of the Ministry of Education and Science of the Republic of Kazakhstan

**Б.Т. Ермагамбет^{1,2}, М.К. Казанкапова¹,
Ж.М. Касенова^{1,2}, А.Т. Наурызбаева¹**

¹«Көмір химиясы және технология институты» ЖШС, Нұр-Сұлтан, Қазақстан;

² «Қазтехнокөмір» ғылыми өндірістік бірлестігі» ЖШС, Нұр-Сұлтан, Қазақстан

ЭЛЕКТРОСПИННИНГ ӘДІСІМЕН ТАСКӨМІР ШАЙЫРЫ МЕН НАНОТЕМІР НЕГІЗІНДЕ НАНОКОМПОЗИТТІ ТАЛШЫҚТЫ СИНТЕЗДЕУ

Аннотация. Мақалада «Шұбаркөл» таскөмір шайыры және нанотемір негізінде нанокөмір талшықтарын электроспиннинг әдісімен зертханалық қондырғыда алу бойынша тәжірибелер жүргізілді. Зерттелетін үлгінің элементтік құрамы анықталып, бет морфологиясы зерттелді. Энергия дисперсиялық рентгендік спектроскопия және СЭМ-микроскопия нәтижесінде элементтік құрамы: С-92,14 %, О-6,16 %, АІ-0,30 %, Si-0,26 %, Р-0,07 %, S-0,20 %, Cl-0,40 %, Fe-0,47 % және көміртегі наноталшығының диаметрі 94,2 нм-ден 800,0 нм-ге анықталды. ИҚ – спектроскопия нәтижелері 2920-2850 см⁻¹ облыстағы шың қарқынының жоғарылайтынын және 2359 см⁻¹ кезінде сигналдың пайда болатынын айқындады, бұл үлгі құрылымындағы бірнеше химиялық байланыстардың үзілуі және нанотемірмен композиттің пайда болуы негізінде түсіндіріледі. Көміртекті наноталшықты алу үшін қолжетімді материалдар пайдаланылды, шикізат пиролизі кезінде пайда болатын «Шұбаркөл» кен орнындағы көмірден таскөмір шайыры, нанокөмір алу үшін КНТ темір наноұнтақтарымен модификацияланды, байланыстырғыш ретінде полиметилметакрилат, еріткіш ретінде 1,2-дихлорэтан пайдаланылды, шикізатты дайындау келесі кезеңдерден тұрады: 1) тас көмір шайыры мен нанотемір ультрадыбыстық ваннада 1,2-дихлорэтанмен 35 °С температурада ерітілген, жиілігі – 35 кГц, ұстау уақыты 30 мин; 2) сондай-ақ полиметилметаакрилат 35 °С температурада ультрадыбыстық ваннада 1,2 – дихлорэтанмен ерітілген (салмақтық үлесі 3%), жиілігі-35 кГц, ұстау уақыты 30 мин; 3) 1 және 2 сатыларында алынған дайын ерітінділер 1:1 қатынасында араластырылады, алынған өнім біртекті масса болу үшін алдыңғы сатыға ұқсас параметрлерімен ультрадыбыстық ваннада араластырылды; 4) дайындалған ерітіндіні шприцті бар электроспиннинг қондырғысына орналастырады, диаметрі 0,6 мм ине түріндегі фильер пайдаланылады, оған 20-25 кВ импульсті жоғары вольтты кернеу орналастырады, шприцпен қабылдағыш арасындағы қашықтық 20-30 см; 5) иіруден кейін талшықтар ауада 300 °С-та тотығады, ұстау уақыты 1 сағат, б) тотығудан кейін 800 °С-та карбонизация үдерісі жүреді, кейін бөлме температурасына сәйкес салқындатылады. КНТ карбонизациясы нәтижесінде тағы бір өнімді алуға болады – көміртекті сфера (КС), бұл зерттеушілер арасында үлкен қызығушылық тудырды, мысалы, газды бөлуде және молекулалық елек, фотонды тыйым салынған аймақтағы кристалдар, катализатор субстраттары және литий-иондық аккумуляторларға арналған электрод материалдары. КС жоғары беткі ауданы мен жоғары құрылымдық тұрақтылығына байланысты тірек субстрат ретінде қызмет етеді. Көмірмен, мұнаймен немесе туынды өнімдермен салыстырғанда тұрақты, арзан энергия сақтау шикізатынан алынған КС қызығушылық тудырды. КНТ карбонизацияланған формасы ИК-Фурье спектромтерінде ешқандай сигнал бермейді. Композитті КНТ алудың әдісі өнеркәсіптік өндірістің перспективті әдісі болып саналады және құрылымдық материалдарға ұсынылған беріктік сипаттамаларына қол жеткізуді анықтайтын салыстырмалы түрде жоғары фракциялы біртектілігі бар өнім алуды қамтамасыз ететін электроспиннинг әдісіне негізделген. Зерттеудің экологиялық әсері көміртекті талшықтар мен соның негізінде композит алу үшін қайталама шикізатты (таскөмір шайыры және көмір өндірудің басқа да қалдықтары) өңдеуге негізделген экологиялық таза технологияны құрудан тұрады. Бұл технологияны құру экономикалық рентабельді өнім ала отырып, қалдықтың осы түрін кәдеге жаратудың экологиялық аспектісін шешуге мүмкіндік береді. Ұсынылған әдіс бірегей, өйткені біз көміртегі талшықтарын алу үшін пайдаланатын шикізат көптеген басқа прекурсорлардан (нейлон, полиэстер, акрил, полипропилен және т.б.) талшықтар алу технологиясымен салыстырғанда жаңартылатын ресурс болып

саналады. Осы зерттеулердің перспективтілігі таскөмір шайырынан көміртекті талшықтарды ауқымды өндіру мүмкіндігі болып есептеледі, бұл Қазақстан нарығында КНТ негізінде отандық өндіріс материалдары мен композиттерінің пайда болуына ықпал етеді.

Түйін сөздер: таскөмір шайыры, нанотемір, нанокөмір талшықтары, электропиннинг, қалыптастыру, тотығу, карбонизация.

Б.Т. Ермагамбет^{1,2}, М.К. Казанкапова¹, Ж.М. Касенова^{1,2}, А.Т. Наурызбаева¹

¹ТОО «Институт химии угля и технологии», Нур-Султан, Қазақстан;

²ТОО "Научно-производственное объединение "Казтехноуголь", Нур-Султан, Қазақстан

СИНТЕЗ НАНОКОМПОЗИТНЫХ ВОЛОКОН НА ОСНОВЕ КАМЕННОУГОЛЬНОЙ СМОЛЫ И НАНОЖЕЛЕЗА МЕТОДОМ ЭЛЕКТРОСПИННИНГА

Аннотация. В статье проведены эксперименты по получению нанокөмір талшықтары на основе каменноугольной смолы «Шубарколь» и наножелеза методом электропиннинга в лабораторной установке. Определен элементный состав и изучена морфология поверхности исследуемого образца. В результате энергодисперсионной рентгеновской спектроскопии и СЭМ-микроскопии был определен элементный состав: С-92,14 %, О-6,16 %, Аl-0,30 %, Si-0,26 %, Р-0,07 %, S-0,20 %, Cl-0,40 %, Fe-0,47 % и диаметр углеродного нановолокна, который составил от 94,2 нм до 800,0 нм. Результаты ИК-спектроскопии показали увеличение интенсивности пиков в области 2920-2850 см⁻¹ и появление сигнала при 2359 см⁻¹, что объясняется разрывом нескольких химических связей в структуре образца и образованием композита с наножелезом. Для получения углеродных нановолокон использованы доступные материалы как каменноугольная смола из угля месторождения «Шубарколь», которые образуются при пиролизе сырья, для получения нанокөмір талшықтары, УНВ модифицирован нанопорошками железа, в качестве связующего был использован – полиметилметакрилат, в качестве растворителя 1,2-дихлорэтан, подготовка сырья состоит из следующих стадий: 1) каменноугольную смолу и наножелезо растворили в 1,2-дихлорэтано в ультразвуковой ванне при температуре 35 °С, частота – 35 кГц, время выдержки 30 мин; 2) полиметилметакрилат также растворили в 1,2-дихлорэтано (массовая доля 3 %) в ультразвуковой ванне при температуре 35 °С, частота – 35 кГц, время выдержки 30 мин; 3) готовые растворы, полученные на стадиях 1 и 2, смешивают в соотношениях 1:1, полученный продукт перемешивали в ультразвуковой ванне при аналогичных параметрах предыдущих стадий для получения однородной массы; 4) приготовленный раствор помещают в установку электропиннинга со шприцом, где использует фильтр в виде иглы диаметром 0,6 мм, к которому прикладывают импульсное высоковольтное напряжение 20-25 кВ, расстояния между приемником шприца 20-30 см; 5) волокна после прядения окисляют при 300 °С на воздухе, время выдержки 1 ч., 6) после окисления проводятся процесс карбонизации при 800 °С, затем охлаждают до комнатной температуры. В результате карбонизации УНВ можно получить еще один продукт – углеродные сферы (УС), которые привлекли значительный интерес среди исследователей из-за их потенциального применения, например, в газовом разделении и в качестве молекулярных сит, кристаллов с фотонной запрещенной зоной, подложек катализаторов и материалов электродов для литий-ионных аккумуляторов. УС служат опорными подложками благодаря их высокой площади поверхности и высокой структурной стабильности, помимо других свойств. По сравнению с углем, нефтью или производными продуктами, УС полученные из устойчивого, недорогого сырья для хранения энергии, стали особенно интересными. Карбонизованная форма УНВ не дает никакого сигнала на ИК-Фурье спектрометре. Предлагаемый способ получения композитных УНВ построен на основе метода электропиннинга, который является наиболее перспективным способом промышленного производства и обеспечивает получение продукта с относительно высокой однородностью фракции, что определяет достижение прочностных характеристик, предъявляемых к конструкционным материалам. Экологический эффект исследования заключается в создании экологически чистой технологии основанной на переработке вторичного сырья (каменноугольная смола и др. отходы угледобычи) для получения углеродных волокон и композитов на их основе. Создание данной технологии позволит решить экологический аспект утилизации данного типа отходов с получением экономически рентабельного продукта. Предложенный способ уникален тем, что сырье, которое используется нами для получения углеродных волокон, является возобновляемым ресурсом, по сравнению с технологией получения волокон из множества других прекурсоров (нейлон, полиэстер, акрил, полипропилен и др.). Перспективность данных исследований заключается в возможности масштабного производства углеродных волокон из каменноугольной смолы, что приведет к появлению на рынке Казахстана материалов и композитов на их основе отечественного производства.

Ключевые слова: каменноугольная смола, наножелезо, нанокөмір талшықтары, электропиннинг, формирование, окисление, карбонизация.

Information about the authors:

Yermagambet Bolat Toleukhanuly, Director of LLP "Institute of Coal Chemistry and Technology", Doctor of Chemical Science, Professor, Nur-Sultan, Kazakhstan, e-mail: bake.yer@mail.ru; <https://orcid.org/0000-0003-1556-9526>;

Kazankapova Maira Kuttybaevna, PhD in Philosophy, LLP "Institute of Coal Chemistry and Technology", Nur-Sultan, Kazakhstan, e-mail: maira_1986@mail.ru; <https://orcid.org/0000-0001-9016-3062>;

Kassenova Zhanar Muratbekovna, Master of Chemical Sciences and Technology, Deputy Director of LLP "Institute of Coal Chemistry and Technology", Nur-Sultan, Kazakhstan, e-mail: zhanar_k_68@mail.ru; <https://orcid.org/0000-0002-9497-7319>;

Nauryzbaeva Asemay Turlangyzy, Bachelor, Junior Researcher of LLP "Institute of Coal Chemistry and Technology", Nur-Sultan, Kazakhstan, e-mail: asemai_2296@mail.ru; <https://orcid.org/0000-0003-4912-3856>

REFERENCES

[1] Lichao Feng, Ning Xie, Jing Zhong (2014) Carbon Nanofibers and Their Composites: A Review of Synthesizing, Properties and Applications, *Materials*, 7:3919-3945. DOI: 10.3390/ma7053919 (in Eng.).

[2] Melechko A. V., Merkulov V. I., McKnight T. E., Guillorn M. A., Klein K. L., Lowndes D. H., Simpson M. L., J. (2005) Vertically aligned carbon nanofibers and related structures: Controlled synthesis and directed assembly, *Journal of Applied Physics* 97, 041301. DOI: [org/10.1063/1.1857591](https://doi.org/10.1063/1.1857591) (in Eng.).

[3] Rempel A.A.(2007) Nanotechnologies, properties and application of nanostructured materials, *Uspekhi khimii* 76 (5): 474-500 (in Russ.).

[4] Ponomarev A.N. (2003) Technologies of micromodification of polymer and inorganic composite materials, *Science and high technologies*. P. 99-101 (in Russ.).

[5] Kerber M.L., (2008) Polymer composite materials. Structure. Properties. Technology, SPb.: Profession. P. 560 (in Russ.).

[6] Tibbetts, G.G., Lake, M.L., Strong, K.L., Rice, B.P. (2007) A Review of the Fabrication and Properties of Vapor-Grown Carbon Nanofiber/Polymer Composites, *Composites Science and Technology*, 67(7-8):1709-1718. DOI: 10.1016/j.compscitech.2006.06.015 (in Eng.).

[7] Yermagambet B.T., Kazankapova M.K., Nauryzbaeva A.T., Mansurov Z.A, Smagulova G.T., Kaidar B.B. (2019) News of the national academy of sciences of the republic of kazakhstan series of geology and technical sciences 4(436):86 – 94. DOI: [org/10.32014/2019.2518-170X.101](https://doi.org/10.32014/2019.2518-170X.101)(in Eng.).

[8] Kaidar B., Argymbaev D., Artykbayeva M., Smagulova G., Mansurov Z.A. (2017) Synthesis of carbon fibers from bitumen of heavy oils by the method of electrospinning, IX international symposium «Combustion and Plasmochimistry», 9: 97-98. (in Eng).

[9] Ermagambet B.T., Kazankapova M.K., Ermogambetov Zh.Kh., Nauryzbayeva A.T., Kanagatov K.G., Abylgazina L.D. (2018) Methods for producing carbon nanofibers from coal pitch. *Reports of the national academy of sciences of the republic of Kazakhstan* 2 (318): 9 – 16 (in Eng.).

[10] Yermagambet B.T., Kazankapova M.K., Nauryzbaeva A.T., Mansurov Z.A, Smagulova G.T., Kaidar B.B. (2019) News of the national academy of sciences of the republic of kazakhstan series of geology and technical sciences 4(436):86–94. DOI: [org/10.32014/2019.2518-170X.101](https://doi.org/10.32014/2019.2518-170X.101) (in Eng.).

REPORTS OF THE NATIONAL ACADEMY OF SCIENCES
OF THE REPUBLIC OF KAZAKHSTAN

ISSN 2224-5227

<https://doi.org/10.32014/2020.2518-1483.115>

Volume 5, Number 333 (2020), 27 – 34

UDC: 634.511

S.N. Oleichenko¹, T.K. Yegizbayeva¹, A.K. Apushev², N.S. Nusipzhanov¹

¹RSE Issyk State Dendrological Park, Almaty region, Kazakhstan;

²LLC "Almaly say", Almaty region, Kazakhstan.

E-mail: oleichenko@mail.ru, togjan26@yandex.ru, apushev-ak@mail.ru, n.nusipzhanov@bk.ru

ASSESSMENT OF PROMISING LOCAL WALNUT FORMS FOR THE SOUTH AND SOUTH-EAST OF KAZAKHSTAN

Abstract. Currently, Kazakhstan has increased interest in nut crops, especially walnuts, which bring stable yields in the most favorable areas for it. Walnut is a valuable product, and its industrial cultivation in the southern regions of the Republic has a certain perspective.

Biometric observations, accounting for productivity and average weight of the fetus and nucleus, and phenological observations were carried out. The General condition of plants was also assessed.

Selected and studied 3 forms established during the period of expedition research in the Almaty region and two in Turkestan. Observations of promising forms of walnuts in two regions have shown that the previously selected forms show a fairly high adaptive stability and yield stable yields of high enough quality. It should also be noted that the fruiting of 2018 Almaty forms took place after winter drops to -33°C and 10 days of steady cooling at the level of 23-28°C. This allows us to include all three promising forms, Aliyar (Issyk), Enbekshikazakh district, Krivenok from Kyrgyzaulda and from the Seidaliev estate, Karasay district. The largest of them is Aliyar, with an average weight of more than 13 g, a core yield of 51%, and not very strong shell. The seidali form is the least large-fruited and does not meet the requirements for the size of the fruit. The form of Kyrgyzaulda also does not reach 11 g, but it has almost a paper shell and an excellent taste of the core, which can even be attributed to dessert. The unique properties of the Turbat nut from the 19th century continue to surprise. No frost damage and saving in more. more than 100 years of age of physiological activity. This year's yield was higher, while maintaining the size of nuts with an average weight of 13 g. Further work is planned to introduce it to culture in vitro for micro-propagation and prepare documentation for recognition as a breeding achievement of global significance.

Key words: walnut, forms, evaluation, selection, phenology, biometrics.

Introduction. Currently, Kazakhstan has increased interest in nut crops, especially walnuts, which bring stable yields in the most favorable areas for it. Walnut is a valuable product, and its industrial cultivation in the southern regions of the Republic has a certain perspective. This is facilitated by favorable soil and climate conditions, and the availability of free space. The South of Kazakhstan is the most favorable region for walnut production [1]. Kazakh horticulture, including the most favorable environmental conditions of the Turkestan region, focuses, with some exceptions, on one fruit crop, the Apple tree. There are more cost-effective directions in the development of Kazakhstan's horticulture that previously were not given due attention. This is primarily nut farming, which is one of the most profitable and competitive industries [2-4]. Even 5 years ago, nut crops and almost only one walnut were cultivated only as household crops or in windbreaks. And plantation planting began to produce only in recent years and not always successfully. In addition to agrotechnical aspects, there were problems with the adaptability of varieties introduced from abroad. The South and especially the South-East of Kazakhstan are not the zone of ecological optimum for walnut culture, and it is exposed here damaged by low

temperatures in winter and frosts in spring. At the same time, in Moldova, Poland and Ukraine, such temperature drops to 25-28°C, and sometimes even 30°C walnut tolerates almost painlessly. This suggests that its adaptability is reduced not only in winter due to temperature differences accompanied by thaws, but also in summer temperatures and humidity. Walnuts are mainly cultivated in a temperate climate and the favorable environmental factors for them are high humidity of the soil and air not only in summer, but also in autumn. An extremely hot and dry climate can worsen preparations for winter and reduce the level of damaging, critical temperatures. It should be remembered that the walnut has even higher requirements for water supply than the Apple tree [5-8]. Such a global variety as Chandler is subjected to winter damage almost everywhere. At the same time, in the South and South-East of the Republic, highly adaptive forms with a fairly high quality of fruit are found in abundance in woodlands and homesteads. Individual copies are more than 100 years old. In this regard, the search for, accelerated assessment and reproduction of highly adaptive local forms is an urgent task.

Objects and methods. Biometric observations, accounting for productivity and average weight of the fetus and nucleus, and phenological observations were carried out. The General condition of plants was also evaluated [9-12].

The objects of study were 3 forms established during the period of expedition research in the Almaty region and two in Turkestan. In addition, the study of 155 promising seed forms from Turkey and a stationary collection of previously selected Saryagash forms in "Saryagash Zher Syyy" LLP will be conducted.

Research conditions. Areas of concentration of promising walnut specimens in the Almaty region are located at altitudes from 700 to 1000 m above sea level in the arid foothill zone and are characterized by a sharply continental climate, low humidity, plenty of sunlight, and a short but rather cold winter.

The transition of air temperature from positive to negative values can occur from the first decade of November, in some years from the second decade of December. Stable snow cover is formed in late November and early December. The duration of the snow period is 85–100 days. The snow cover is uneven its height is on average 20–35 cm. during frequent winter thaws, there is a complete snow cover convergence. The absolute minimum temperature registered on the territory of the experimental farm is -36 °C. A steady transition of air temperature through 0°C in spring occurs at the end of the second and beginning of the third decade of March. The spring period is short 30-50 days, with a sharp increase in temperature and a daily temperature fluctuation. Frosts with snowfall are often observed. Frosts stop in the last decade of April – the first decade of May. The average duration of the frost-free period in this zone is 150–170 days. In spring, the main reserves of soil moisture accumulate due to precipitation (March-may), when almost half of the entire annual rate falls. The maximum temperature recorded in spring is +35 °C. The longest season of the year is summer (120–180 days). The hot period can start from the second decade of April, and continue until the second decade of October. The average temperature is +20+24°C. The amplitude of daily fluctuations in daytime and night temperatures is quite high and is on average more than 20°C. The sum of positive temperatures for the summer period is 3450–3750°C, and the sum of temperatures for the period above 10°C ranges from 3100–3400°C. Relative humidity decreases in early June due to a sharp increase in air temperature and is within the range of 46–48%, with an average annual 55-60%. The amount of precipitation in comparison with spring significantly decreases, 2–3 times, during the summer the monthly precipitation rate may fall for 1 day.

The autumn temperature transition through 15°C begins in the third decade of September - early October, the duration of this period ranges from 30 to 50 days. The amplitude of daily fluctuations in daytime and night temperatures reaches 25–30 °C.

Annual precipitation ranges from 350–420 mm. During the warm period of the year, 120–300 mm of precipitation falls.

The foothill soils are gray-chestnut, mostly medium-loam and dusty. The humus horizon is clearly defined, has a brownish color and a thickness of up to 26-30 cm, contains from 2 to 2.8 % of humus. The content of the main nutrition elements in the soil is as follows: N-6-9mg/100 g, P₂O₅-2-4mg/100 g, K₂O-mg/100 g.

In the upper part of the soil zone, there are richer humus-free mountain chernozems with a humus content of 5-6%.

For the South of Kazakhstan, the most typical are gray-earth soils. They have such a characteristic-the Soil profile of light loamy serozems is characterized by the following morphological features and properties:

According to mechanical analysis, the soil data is medium loam, since the content of particles less than 0.01 mm in the 0-0.25 cm horizon is-30.62-33.76%, in the layer of 25-50 cm-29.78-35.11%. The predominant fraction in the composition of mechanical soil fractions is coarse dust (particles 0.05-0.01 mm) - 37.18 - 43.99% and fine sand (particles 0.25 - 0.01 mm) - 24.66-27.94%.

According to chemical analysis in the upper 0-25 cm horizon, this soil variety contains humus 0.74-0.96%, and in 25-50 cm-0.26-0.40%. The average humus content in the 0-50 cm layer is 0.56%.

According to the analysis of water extraction, the described soils are not salted with easily soluble salts, since the dense residue over the entire soil profile does not exceed 0.056-0.060%.

Care for the plantings consisted of watering during the hot season at the collection site in Saryagash Zher Syyy. In other areas, there was a natural background of water supply. Pesticides and fertilizers were also not used.

Results and discussion. In 2019, the study of promising forms and varieties was continued in order to further adapt them to the conditions of the South and South - East of Kazakhstan. Selected and studied 3 forms established during the period of expedition research in the Almaty region and two in Turkestan. In addition, the study of 155 promising seed forms from Turkey and a stationary collection of previously selected Saryagash forms in "Saryagash Zher Syyy" LLP will be conducted. Observations of the dynamics of development of the selected forms and varieties showed that there were no significant changes in the onset of individual development in control plants compared to the previous year. the beginning of vegetation, determined by the beginning of growth of shoots, was also delayed by about two weeks, and flowering by 7-8 days compared to the Apple tree (table 1). There are also differences in phenology in the two zones we study, the South and South-East. In the South, due to the significantly greater heat supply of the region, the phenological phases of the development of the walnut plant take place about 1 month earlier.

Biometric observations were also continued during the current year. There was a slight increase in age trees and a more significant increase in young trees (table 2).

For example, in the studied Turkish forms, the increase in the rate of infertility reached 10-13%. The same trend was observed in relation to the diameter of the stem and the size of the crown projection.

It should also be noted Almaty from the estate of Krivenok, p Kyrgauldy. It did not have enough 2 g to reach the standard size by European standards, but this form was distinguished by the most easily cracked shell, almost like the representatives of the paper group of varieties. The fruits of this form also had a better taste compared to all the studied forms. In 2019, a new form was installed in the village of Almaty. It is characterized by large fruits with a not very strong shell and a good taste of the fruit. It is also distinguished by the lateral type of fruiting. According to the Turkish forms, you can already make preliminary conclusions in accordance with their speed and large-scale fruitfulness. Their fruiting began at 4 years, all of them are relatively large-fruited. No winter damage was noted on them. The most interesting are 3 forms. One for their productivity, and two for the large size. The same expedition work to study the genetic resources of walnuts was carried out in other regions of southern Kazakhstan [13].

It should also be noted that the high level of fruit damage in 2019 at the stationary collection in "Saryagash Zher Syyy" LLP reached 10-15% of the fruitworm.

Observations of promising forms of walnuts in two regions have shown that the previously selected forms show a fairly high adaptive stability and yield stable yields of high enough quality. It should also be noted that the fruiting of 2018 Almaty forms took place after winter drops to-33°C and 10 days of steady cooling at the level of 23-28°C. This allows us to include all three promising forms, Aliyar (Issyk), Enbekshikazakh district, Krivenok from Kyrgyzaulda and from the Seidaliev estate, Karasay district. The largest of them is Aliyar, with an average weight of more than 13 g, a core yield of 51%, and not very strong shell. The seidaliev form is the least large-fruited and does not meet the requirements for the size of the fruit. The form of Kyrgyzaulda also does not reach 11 g, but it has almost a paper shell and an excellent taste of the core, which can even be attributed to dessert.

Table 1-Phenological development of various varieties and forms of walnuts

	Varieties and forms	Tree age	Start of growth of shoots	Beginning of flowering	The appearance of the ovaries	Beginning of maturation (darkening of the exocarp)	Maturation after collection	Defoliation
1	Seydaliev	13	3rd decade of April	End of the 1st decade of may	End of the 2nd decade of may	early October	mid-October	3rd decade of October
2	Krivenok	20	3rd decade of April	End of the 1st decade of may	End of the 2nd decade of may	early October	mid-October	3rd decade of October
								Latitude 43°10'52" N; Longitude 76°50'40" E
3	Aliyar	28	3rd decade of April	End of the 1st decade of may	End of the 2nd decade of may	early October	mid-October	3rd decade of October
								Latitude 43°10'28" N; Longitude 76°45'50" E
3	Ideal	17	End of March-Beginning of April	April 10	End of the 2nd decade of April	end of September	Early-mid November	November 17
								Almaty region, Enbekshikazakh district, Almaty village, 950 m above sea level.
4	T-8/13	5	-	-	-	end of September	-	-
6	T-6/14	5	-	-	-	end of September	-	-
7	T-7/2	5	-	-	-	end of September	-	-
8	T-8/9	5	-	-	-	end of September	-	-
9	Liaoh-1	8	-	-	-	end of September	-	-
10	Rootstock of Liaoh-1	7	-	-	-	end of September	-	-
11	Saryagash - 11/14	≈16	-	-	-	end of September	-	-
12	Saryagash - 4/9	≈26	-	-	-	end of September	-	-
13	Saryagash - 12	≈41	-	-	-	end of September	-	-
14	Saryagash - 22	≈36	-	-	-	end of September	-	-
15	Keles - 6	≈51	-	-	-	early October	-	-
16	Turbat	≈130	1 decade of April	2 decade of April	beginning of the 3rd decade of April	early October	-	-

Table 2. Biometric observation data

Varieties and forms	The height of the tree, m		Diameter of the stem, see		Crown diameter, m		The number of fruits on the tree, pieces		Average fruit weight, g/out of the nucleus %		Crop, tree/kg	
	2018	2019	2018	2019	2018	2019	2018	2019	2018	2019	2018	2019
1. Seydaliyev	4,5	4,5	17	17	5,5	5,5	2525	3292	8,1/50	8,2/50	≈21	≈27
2 Krivenok	5,6	5,8	22	23	7,5	7,8	2650	3870	9,0/51	9,3/52	≈24	≈36
3 Aliyar	6	6,2	26	28	7,9	8,1	2830	3383	13,0/51	13,3/51	≈37	≈45
4 Ideal	6,4	6,8	15	17	6	6	710	504	10,2/50	10,5/51	7,2	5,3
5 T-8/13	2,5	2,9	5,4	5,7	1,8	2,1	85	196	13,5/50	13,2/50	1,2	2,6
6 T-6/14	2,2	2,5	4,9	5,2	1,6	1,8	75	192	12,7/52	12,5/52	1	2,4
7 T-7/2	2,4	2,8	4,8	5,1	1,4	1,7	53	200	13,2/51	13/51	0,7	2,6
8 T-8/9	2,8	3,1	4,6	4,9	1,7	2	33	239	13,5/53	13,8/53	0,5	3,3
9 Liaobe-1	3,2	3,5	11,8	12,2	2,4	2,8	106	247	21,9	22,2/52	2,3	5,5
10 Rootstock of Liaobe-1	3,3	3,7	12,2	13	2,6	3	517	807	7,5/51	7,8/51	3,9	6,3
11 Saryagash - 11/14	5,5	5,7	15	17	5,7	6	1020	806	12,1/52	12,4/53	12,3	10
12 Saryagash - 4/9	11,6	12	47	49	5	5	1230	672	16,6/52	17,1/53	20,4	11,5
13 Saryagash - 12	9,6	10	36	38	7,6	8,2	1330	1174	13,1/51	13,2/51	17,7	15,5
14 Saryagash - 22	8,2	8,5	23	26	5,8	6,1	1238	1094	11,5/50	11,6/50	14,2	12,7
15 Keles - 6	9,6	10	35	38	7,5	8	1767	1533	11,7/51	12/51	18	18,4
16 Turbat	15	15	120	120	20	20	6125	6538	13,3/51	13/51	≈81	≈85

In the study of the forms found in Turkestan region by Shantsevym T. B also have a very promising form. Of great interest is the Chinese, low-growing variety Liaohe-1 with fruits weighing more than 20 g and paper shells. Its disadvantage, noted in plantings of 10-11 years – it is not high enough resistance to bacterial burn in the year of planting. However, this problem was solved by agronomic with special postlepoludennoe mash, which is added to topsin. We also selected 4 promising short term Turkish forms that formed the first fruits for 4 years after planting with a weight of about 13 g They show no signs of winter damage.

The unique properties of the Turbat nut from the 19th century continue to surprise. No frost damage and saving in more. more than 100 years of age of physiological activity. This year's yield was higher, while maintaining the size of nuts with an average weight of 13 g. Further work is planned to introduce it to culture in vitro for micro-propagation, which we have worked out [14] and prepare documentation for recognizing it as a breeding achievement of global significance.

Conclusion. The prospects for the use of local forms of high-quality fruits for their accelerated micro-propagation and plantation cultivation in the conditions of the Almaty and Turkestan regions have been established. Of most interest are the form A. and Krivenok for South-East Akim to the South. In the South, the Liaohe-1 variety is also promising if preventive measures are taken to combat bacteriosis in the post-planting period. A comprehensive assessment of the four perishable Turkish forms should be continued. It is also necessary to carry out targeted introduction of complex resistant varieties with lateral fruiting type from abroad.

С.Н. Олейченко¹, Т.Қ. Егізбаева¹, А.Қ. Апушев², Н.С. Нүсіпжанов¹

¹ «Есік мемлекеттік дендрология саябағы» РМҚК, Алматы облысы, Қазақстан;

² «Алмалы сай» ЖШС, Алматы облысы, Қазақстан

ҚАЗАҚСТАННЫҢ ОҢТҮСТІК ЖӘНЕ ОҢТҮСТІК-ШЫҒЫСЫНДАҒЫ ГРЕК ЖАҢҒАҒЫНЫҢ ЖЕРГІЛІКТІ ПЕРСПЕКТИВТІ ФОРМАЛАРЫН БАҒАЛАУ

Аннотация. Қазіргі уақытта Қазақстанда жаңғақ дақылына, соның ішінде қолайлы аймақта тұрақты өнім беретін грек жаңғағына қызығушылық артуда. Грек жаңғағы өте бағалы тағамдық өнім, оны республикамыздың оңтүстік өңірлерінде өнеркәсіптік деңгейде өсіру өте перспективті болып саналады. Аталған өңір өсіруге қолайлы топырақ-климат жағдайы мен бос танаптық аймақ болып есептеледі. Қазақстанның оңтүстігі – грек жаңғағын өсіруге айтарлықтай қолайлы аймақ. Түркістан облысы көп жыл бойы негізінен тек алма дақылын өсіруге бағытталған. Қазақстанның бақ шаруашылығын дамытуда бұрын жақсы көңіл бөлінбеген айтарлықтай экономикалық тиімді бағыт – жаңғақ шаруашылығы. Ол бірінші кезеңде табысты және бәсекеге қабілетті сала болып саналады. Грек жаңғағы негізінен қоңыржай аймақта өсетін дақыл болғандықтан, ол үшін қоршаған ортаның жаз және көктем айындағы топырақ және ауа ылғалдылығы қолайлы болып есептеледі. Өте ыстық және құрғақ климат өсімдіктің қысқа дайындығын төмендетіп, аязда зақымдайды. Есте сақтайтын жағдай, грек жаңғағының алма ағашына қарағанда ылғалға деген талабы өте жоғары. Әлемге танымал сорт Чандлер, барлық жерлерде қыста зақымданған. Сонымен бірге республиканың оңтүстік және оңтүстік шығысында орман алқабында және үй аймағында жоғары бейімделген, жемісі айтарлықтай сапалы формалар кездеседі. 100 жылдан асқан жеке түрлер де кездеседі. Осыған байланысты бейімділігі жоғары жергілікті формаларды іздеп, жылдам бағалап және көбейту маңызды тапсырма болып саналады.

Биометриялық бақылау, өнім есептеу және жеміс пен ішкі ядроның орташа салмағы, фенологиялық бақылау жұмыстары жүргізілді.

Зерттеу нысаны болып Алматы және Түркістан облыстарына жүргізілген экспедициялық зерттеу жұмыстары кезінде анықталған грек жаңғағының 3 формасы алынды. Одан басқа «Сарағаш жер сыйы» ЖШС стационарлық коллекциясынан сұрыпталған Сарағаш формалары мен Түркиядан әкелінген 155 тұқымдық перспективалық формалар зерттелді.

Биыл биометриялық бақылаулар жалғастырылды. Үлкен ағаштың баяу және жас ағаштың өскендігі анықталды.

Мысалға, ерте жетілуі арқылы ерекшеленетін зерттелген Түрік формаларының өсімі 10-13% артты. Осындай өсім бағананың диаметрі мен тәждің көлемінен байқалды.

Екі аймақтағы перспективті формаларға жүргізілген зерттеулер бұрын таңдалған формалардың бейімдел-гіштігі жоғары және сапалы, тұрақты өнім беретіндігін анықтады. Тағы бір айта кететін жағдай, 2018 жылғы қысқы -33 °С және 10 күн бойы 23-28 °С тұрақты аяздан кейін алматылық формалардың жеміс

беру үдерісі. Алияр (Есік формасы), Еңбешіқазақ ауданы, Кривенок Қырғауылдыдан және Сейдалиев аумағынан Қарасай ауданынан алынған барлық үш перспективті формалардың суыққа төзімді екенін көрсетеді. Осы формалардың ішіндегі ең орташа салмағы жоғарысы алияр – 13 г жоғары, ядро шығымы 51% және сыртқы қабығы аса қатты емес. Сейдалиев формасы орташа ірі болғандықтан жемістің көлеміне қойылатын таптарға сай келмеді. Қырғауылды формасының да салмағы 11 г жетпеді, бірақ оның қабығы өте жұқа қағаз тәрізді және ядросы дәмді әрі десерттік топқа жатқызуға болады. Түркістан облысында Т.Б. Шынтасовтың формаларға жүргізген зерттеулерінен айтарлықтай перспективті формалар анықталды. Соның ішінде қытайлық кішкентай жеміс салмағы 20 г асатын және қағаз тәрізді қабығы бар Ляохэ-1 сорты үлкен қызығушылық тудыруда. Оның бір кемшілігі, 2010-2011 жылдары отырғызылған ағаштардың сол жылы бактериялық күйік ауыруына шалдығуы. Бірақ бұл мәселе арнайы агротехникалық шара, яғни топсин қосылған сұйықтықпен ортырғызғаннан кейін суару арқылы шешілді. Одан басқа 4 жылдам жеміс беретін перспективті түрік формалары іріктелді, бұл формалар отырғызғаннан кейін 4-жылы салмағы 13 асатын жеміс берген. Олардан қысқы зақымдану белгілері байқалмады.

19 ғасырдан жеткен турбат грек жаңғағының ерекше қасиеттері таң қалдыруда. Яғни, аязда зақымданбайды және 100 жылдан аса уақыт өтсе де физиологиялық белсенділігі сақталған. Биылғы жылдық өнімі мен жемісінің орташа салмағы 13 г жоғары. Бұл форманы *in vitro* жағдайында микроклонды көбейтіп және жаһандық маңызы бар селекциялық жетістік ретінде тану үшін құжаттама дайындау жоспарлануда.

Түйін сөздер: грек жаңғағы, формалар, бағалау, сұрыптау, фенология, биометрия.

С.Н. Олейченко¹, Т.К. Егизбаева¹, А.К. Апушеа², Н.С. Нусипжанов¹

¹РГКП «Иссыкский государственный дендрологический парк», Алматинская область, Казахстан;

²ТОО «Алмалы сай», Алматинская область, Казахстан

ОЦЕНКА ПЕРСПЕКТИВНЫЕ МЕСТНЫХ ФОРМ ГРЕЦКОГО ОРЕХА ДЛЯ ЮГА И ЮГО-ВОСТОКА КАЗАХСТАНА

Аннотация. В настоящее время в Казахстане возрос интерес к орехоплодным культурам, особенно к грецкому ореху, приносящему стабильные урожаи в наиболее благоприятных для него зонах. Грецкий орех является ценным продуктом питания и его промышленное выращивание в южных регионах республики имеет определённую перспективу. Этому способствуют благоприятные почвенно-климатические условия и наличие свободных площадей. Юг Казахстана является наиболее благоприятным регионом для производства грецкого ореха. Казахское садоводство, в том числе и наиболее благоприятной по экологическим условиям Туркестанской области, ориентируется, за отдельными исключениями, на одну плодую культуру – яблоню. Существуют более экономически выгодные направления в развитии казахского садоводства, которым раньше не уделялось должного внимания. Это в первую очередь ореховодство, являющееся одной из самых прибыльных и конкурентноспособных отраслей. Грецкий орех – культура в основном умеренного климата и для него благоприятными факторами внешней среды являются высокая влажность почвы и воздуха не только летом, но и осенью. Экстремально жаркий и сухой климат может ухудшить подготовку к зиме и снизить уровень повреждающих, критических температур. Необходимо помнить, что грецкий орех предъявляет даже более высокие требования к влагообеспечению, чем яблоня. Такой глобальный сорт, как Чандлер подвергается зимним повреждениям практически повсеместно. При этом на юг и юго-востоке республики в изобилии встречаются в лесопосадках и приусадебных участках высокоадаптивные формы с достаточно высоким качеством плодов. Отдельным экземплярам более 100 лет. В связи с этим поиск, ускоренная оценка и размножение высокоадаптивных местных форм является актуальной задачей.

Проводились биометрические наблюдения, учет продуктивности и средней массы плода и ядра, фенологические наблюдения. Оценивалось также общее состояние растений.

Объектами изучения были 3 формы установленные в период проведения экспедиционных исследований в Алматинской области и две в Туркестанской. Кроме этого, проводится изучение 155 перспективных семенных форм из Турции и стационарной коллекции отобранных ранее Сарыагашских форм в ТОО "Сарыагаш Жер Сыйы".

В течение текущего года были также продолжены биометрические наблюдения. Установлено незначительное увеличение возрастных деревьев и более существенное у молодых.

Например, у изучаемых Турецких форм выделившихся по скороплодности увеличение достигло 10-13%. Также тенденция наблюдалась и в отношении диаметра штамба величины проекции кроны.

Наблюдения за перспективными формами грецкого ореха в двух регионах показали, что отобранные ранее формы проявляют достаточно высокую адаптационную устойчивость и дают стабильные урожаи достаточно высокого качества. Следует также отметить, что плодоношение 2018 года Алматинских форм проходила после зимних понижений до -33 °С и 10 дней устойчивого похолодания на уровне 23-28 °С. Это позволяет отнести все три перспективных формы Алияр (Иссыкская), Енбекшиказахский район, Кривенок из

Кыргаулды и из усадьбы Сейдалиева, Карасайского района. Самая крупноплодная из них Алияр, средней массой более 13 г, выходом ядра 51% и не очень крепкой скорлупой. Сейдалиевская форма наименее крупноплодная и не соответствует требованиям, предъявляемым к размеру плода. Форма из Кыргаулды также не достигает 11 г, но имеет почти бумажную скорлупу и отличный вкус ядра, который можно даже отнести к десертным. При изучении форм, найденных в Туркестанской области, Шынтасовым Т. Б. также установлены достаточно перспективные формы. Большой интерес представляет Китайский, слаборослый сорт Ляохэ-1 с плодами массой более 20 г и бумажной скорлупой. Его недостаток, отмеченный в посадках 10-11 года – это недостаточно высокая устойчивость к бактериальному ожогу в год посадки. Однако эта проблема была решена агротехническим путём с помощью специальной послепосадочной болтушки, в которую добавляется топсин. Отобраны также 4 перспективные скороплодные турецкие формы образовавшие первые плоды на 4 год после посадки с массой порядка 13 г. На них не отмечено признаков зимних повреждений.

Уникальные свойства Турбатского ореха из 19 века продолжают удивлять. Никаких морозобойных повреждений и сохранение в более чем 100-летнем возрасте физиологической активности. Урожайность этого года была выше, при сохранении размеров орехов средней массой 13 г. Планируется дальнейшая работа по введению его в культуру *in vitro* для микроразмножения и подготовка документации для признания его селекционным достижением глобального значения.

Ключевые слова: грецкий орех, формы, оценка, отбор, фенология, биометрия.

Information about the author:

Oleychenko Sergey Nikolaevich -doctor of agricultural Sciences, chief scientific officer of the Issyk state arboretum Park, oleichenko@mail.ru, <https://orcid.org/0000-0002-0611-8267>;

Yegizbayeva Togzhan Kadylbekovna is a senior researcher in the Issyk arboretum state Park, togjan26@yandex.ru, <https://orcid.org/0000-0002-3333-8839>;

Apushev Amangeldy Kairbekovich - doctor of agricultural Sciences, chief scientific officer of Almaly say LLP, apushev-ak@mail.ru, <https://orcid.org/0000-0001-7114-0391>;

Nusipzhanov Nurdan Sebegatovich -senior researcher of the Issyk state arboretum Park, n.nusipzhanov@bk.ru. <https://orcid.org/0000-0003-4249-0186>

REFERENCES

[1] Kairova G. N. Prospects of walnut production in Kazakhstan // Collection of materials of the international scientific and practical seminar "Providing the nut growing industry of Kazakhstan with high-quality planting material of promising forms and varieties". 2018, P. 6-9. (in Russ.).

[2] Aleschenko S. N. Bookmark walnut plantations in the South of Kazakhstan. // Collection of materials of the international scientific and practical seminar "Providing the nut growing industry of Kazakhstan with high-quality planting material of promising forms and varieties". 2018, P. 10-13. (in Russ.).

[3] Shyntasov T. Rustle walnut groves. Kazakhstanskaya Pravda newspaper. 2018. Issue 6. P. 3-4. (in Russ.).

[4] www.orehovod.com. Extensive analysis of the world walnut market, 2016-2017. (in Russ.).

[5] Vasin E. A. Selection and evaluation of promising forms of walnut for the middle zone of Russia. Abstract of the dissertation for the degree of candidate of agricultural Sciences spider. Saint Petersburg-Pushkin 2004. (in Russ.).

[6] Sokolova V. V., Ermakov M. A. Selection of perspective forms of walnut *Juglans regia* L. according to the economically valuable signs of the fruit in the main Botanical garden of the Russian Academy of Sciences. Collection of scientific papers-fruit And berry growing in Russia. 2017; 49: P. 303-306. (in Russ.).

[7] Ozol A. M., Horkov. E. I. Walnut, its introduction and acclimatization. Under the editorship of V. M. Kultysheva. Publishing house of the Academy of Sciences of the Latvian SSR, Riga 1968. (in Russ.).

[8] Sokolov S. Ya. Modern state of the theory of acclimatization and plant introduction // Tr. BIN an USSR, ser 6 1657, issue 5, P. 9-32. (in Russ.).

[9] Dzhigadlo E. N., Dolmatov E. A., Zhdanov V. V. program and method of variety study of fruit, berry and nut crops. (Under the General editorship of RASKhN academician E. N. Sedov and doctor of agricultural Sciences T. p. Ogoltsova) – Orel: Publishing house of the all-Russian research Institute of fruit crop selection, 1999. P. 493-534. (in Russ.).

[10] Poirier, M // A semi-physiological model of cold hardening and hardening in walnut stem / A. Lacoste, T. Améglio// Tree Physiol. 2010. Vol. 12. P. 1555–1569.

[11] Kartelev, V. G. Method of individual selection of promising individuals in the offspring of plus trees of the walnut tree [Text] / V. G. Kartelev. Ijevan: Armenian scientific research. experimental station, 1977. - 8 p. (in Russ.).

[12] Balabanov I. M. Biological aspects in the breeding of walnut. The scientific journal of the Kuban state agrarian University, no. 101(07), 2014. C-1-15. (in Russ.).

[13] Yaşar A, Yusupov B. Y, Erdenov M, Kourosh V. Exploring of Walnut Genetic Resources in Kazakhstan and Evaluation of Promising Selection. International Journal of Horticultural Science and Technology Vol. 7, No. 2; June 2020, pp 93-102. DOI: 10.22059/ijhst.2020.299930.352.

[14] Yegizbayeva T.K., Yausheva T.V., Oleichenko S.N., Licea-Moreno R.J. Influence of nutrition compositions on microclonal propagation different genotypes of the walnut *Juglans Regia* L Bulletin of national academy of sciences of the republic of Kazakhstan ISSN 1991-3494 Volume 1, Number 383 (2020), 105 – 112 <https://doi.org/10.32014/2020.2518-1467.13>

**REPORTS OF THE NATIONAL ACADEMY OF SCIENCES
OF THE REPUBLIC OF KAZAKHSTAN**

ISSN 2224-5227

<https://doi.org/10.32014/2020.2518-1483.116>

Volume 5, Number 333 (2020), 35 – 41

UDC 63.636.2.034/636.082

K.Zh. Zhumanov^{1,2}, T.N. Karymsakov¹, M.A. Kineev¹, A.D. Baimukanov³¹Kazakh Scientific Research Institute of Animal Breeding and Fodder Production, Almaty, Kazakhstan;²Federal Science Center for Animal Husbandry - VIZh named after academy member L.K. Ernst,
Podolsk, Moscow region, Russian Federation;³Russian State Agrarian University - Moscow Agricultural Academy named after K.A. Timiryazev, Moscow, Russia.E-mail: kano_zh@mail.ru, kartalgat@mail.ru, k_maratAK@mail.ru, aidartaidar98@mail.ru**ESTIMATED BREEDING VALUES OF SERVICING BULLS
OF THE HOLSTEIN BLACK-AND-WHITE BREED BY QUALITY
OF OFFSPRING USING THE BLUP METHOD**

Abstract. The aim of the research was to estimate the breeding value of the servicing bulls of the Holstein black-and-white breed according to the optimized equation of the mixed BLUP model. Within a comparative aspect, the estimation results of bulls calculated using the BLUP methodology are presented. As an object of the research, information was used on first-calf heifers (daughters of the evaluated bulls), who lactated in breeding herds of the Holstein cattle of the Republic of Kazakhstan in 2016-2017. The source was the official information analytical system (IAS) of livestock breeding of the Republic of Kazakhstan. The analysis of information on the dairy productivity of the cows-daughters of the estimated bulls was performed according to the indicators of the milk yield, the contents of fat and protein in milk, the milk fat and protein yield for 305 days of lactation and the study period.

To compare the obtained results, the average values of breeding value indices, the reliability of their assessment, and the rank correlation coefficients were calculated.

Keywords: servicing bulls, breeding value, dairy productivity, reliability, correlation, BLUP method.

Introduction. The estimated breeding value consists of obtaining information on the bull genotype with maximum accuracy. These requirements are most fully met by the Best Linear Unbiased Prediction (BLUP) procedure based on mixed-type linear statistical models. BLUP takes into account both environmental and genetic factors affecting the variability of traits of dairy productivity. When developing the methodology for the index estimation of the breeding value of servicing bulls of domestic breeds on the quality of offspring using the BLUP method, it is advisable to use as a basis the principles of international methods used to evaluate breeds related to domestic breeds [1].

According to D.A. Baimukanov, et al. all data on the productive and exterior indicators of cattle are entered into the program of the information-analytical system (IAS), where the estimated breeder value of the studied cows is automatically calculated. The average estimated breeding value (EBV) for all breeds was 81.4. Among all breeds, the highest EBV level was determined for Holstein cows (84.3) of imported selection [2].

Further productivity of cows depends on their reproductive ability and timely preventive measures against infertility [3].

The relevance of the research is the need to improve breeding work in dairy cattle breeding in Kazakhstan through the development of new and adaptation of digital technologies for estimation of the breeding value of animals existing in world practice, in particular using the mathematical BLUP method.

Material and brief research methodology. The research materials were data of phenotypic indicators of dairy productivity of first-calf cows (milk yield, fat and protein content, milk fat, and protein yield) of the Holstein black-and-white dairy cattle breed, obtained from the database of the information-analytical system of the Republic of Kazakhstan for 2016-2017. The estimated breeding value of bulls by productive indicators of daughters was carried out based on the methodological principles of the BLUP Sire Model [4]. The reliability of the obtained values of the estimated breeding values of servicing bulls

using the mixed model equation was determined based on the estimation of the confidence coefficient determined by the values of the diagonal elements of the inverted submatrix Z'Z [5]. The coefficient of rank correlation was determined using the Spearman formula. Analysis of the research results was done using common methods of statistical data processing used in biological research. [6, 7, 8, 9, 10, 11, 12].

Research results. Estimation of breeding value of bulls according to the dairy productivity of daughters for independent (2016 and 2017) years and the aggregate (2016-2017) period was performed using the optimized equation of the BLUP mixed model:

$$y_{ijk} = \mu + HYS_i + s_j + b_1 A_{jk} + b_2^2 L_{pjk} + e_{ijk}$$

where: y_{ijk} – estimated indicator (milk yield, fat content in milk, protein content in milk, milk fat yield, milk protein yield) of the k-th first-calf heifer, daughter of the j-th bull, lactating in the i-th gradation "herd - year - season", (vector of phenotypic values); μ – population constant; HYS_i – fixed factor of the i-th gradation "herd-year-season"; $b_1 A_{jk}$ – coefficient of linear regression of the trait of productivity on age at the calving of the k-th first-calf heifer; A_{jk} – age (in months) of the k-th first-calf heifer; $b_2^2 L_{pjk}$ – coefficient of quadratic regression of the productivity trait by the number of milking days during the 1st lactation of the k-th first-calf heifer; L_{pjk} – duration of lactation (in days) of the k-th first-calf heifer; s_j – randomized effect of the j-th servicing bull ($O, I\delta_s^2$); e_{ijk} – residual (randomized) effect of the model ($O, I\delta_e^2$).

The calculations were carried out in a computer program specially developed by RISC "Mospleminform" specialists according to our developed algorithms.

It should be noted that in countries with developed dairy cattle breeding, only those bulls with the confidence index of its results exceeding the reliability value equal to 0.60 [13, 14], which with a sufficient degree of confidence allows us to judge genetic features of the estimated animals.

Based on the results, the analysis of the estimated breeding value of the servicing bulls for independent years and for the total period. The characteristics of the analysis data are given in table 1.

In the first year of the analysis (2016), of 256 tested bulls used in the reproduction system with the corresponding reliability criterion ($Rel \geq 0.60$), only 29 servicing bulls or 12.5% of the number of the tested were satisfied. The average number of daughters per one estimated bull was 30 animals, the average number of effective daughters was 20, and the average number of HYS gradations was 4.6. The average estimated breeding value of servicing bulls for milk yield was -15.64 kg and ranged from -598 kg to +616 kg; the yield of milk fat and protein -1.09 and -0.11 kg, respectively, and were in the range from -24.1 kg to +24.8 kg); according to the fat and protein content in milk - 0.01 and +0.01% respectively, varying from -0.13% to + 0.14%, with an average value of the confidence coefficient equal to 0.70. In 2017, out of 152 servicing bulls, 40 animals or 26.9% met these requirements. The average load on one estimated bull was 40 daughters, the average number of effective daughters was 27, and the average number of effects of HYS factors was 1.3 gradations more than in 2016. The average estimated breeding values of bulls were: -39.09 kg for milk yield in the range from -479.3 kg to +566.8 kg; -1.60 and -2.56 kg in the yield of milk fat and protein; according to these indicators, the values ranged from -24.8 to +27.4 kg; -0.01% and -0.02% - according to the fat and protein content in milk in the range from - 0.20% to + 0.16% respectively, with an average confidence coefficient of 0.73.

Table 1 - General characteristics of the estimation results of servicing bulls using the BLUP method

Years	BLUP estimate (confidence coefficient over 0.60)									
	The number of estimated bulls, animals	Average values				Average estimated breeding values of servicing bulls				
		The number of HYS gradations	The number of daughters, animals	The number of effective daughters	Confidence coefficient	Milk yield, kg	Fat, %	Fat, kg	Protein, %	Protein, kg
2016	29	4.6	30	20	0.70	-15.64	-0.01	-1.09	+0.01	-0.11
2017	40	5.9	40	27	0.73	-39.09	-0.01	-1.60	-0.02	-2.56
2016-2017	57	7.1	48	33	0.75	-15.93	-0.01	-0.67	-0.01	-0.44

In the aggregate analysis period (2016-2017), out of 407 bulls, 57 animals were evaluated based on the productivity of their daughters, or 49.12%, and 29.8% more than in independent years. The average number of daughters per one estimated servicing bull was 48 animals, i.e. 18 and 8 animals more than in 2016 and 2017, respectively, with the average number of effective daughters of 33.7 and the average number of gradations of paratypical factors (per bull) - 7.1. The average estimated breeding values were equal: -15.93 kg for milk yield, in the range from -1169.6 kg to +598.1 kg; -0.01% in terms of fat content in milk, in the range from -0.12% to +0.17%; -0.67 kg of milk fat yield, in the range from -45.1 kg to +43.8 kg; -0.01% of to the protein content in milk, in the range from -0.11% to +0.05%; -0.44 kg of the protein in milk in the range from -40.8 kg to +34.3 kg. Herewith, the average reliability coefficient of these indicators in the aggregate period was 0.75.

In the opinion of many Russian scientists, (Kuznetsov V.M., Kharitonov S.N.) the use of all available information on daughters when estimating the breeding value of servicing bulls with the BLUP method is its obvious advantage, increasing the accuracy (reliability) of the forecast of the bull genotype, as shown by real data, by 30% [14, 15].

A certain scientific interest, which has practical importance, is the comparison of revaluation data for 16 bulls from among all producers evaluated with the BLUP method using information for independent years and in the cumulative period (Tables 2, 3).

Table 2 - Estimated breeding values of bulls with revaluation results for the next year

Years	BLUP estimate (confidence coefficient over 0.60)								
	The number of estimated (2016) and subsequently reevaluated bulls (2017), animals	Average values			Average estimated breeding values of servicing bulls				
		Number of daughters, animals	The number of effective daughters	Confidence coefficient	Milk yield, kg	Fat, %	Fat, kg	Protein, %	Protein, kg
2016	16	43	26.0	0.74	-31.53	0.00	-1.50	0.01	-1.35
2017		39	27.7	0.75	-128.62	-0.02	-5.47	-0.04	-6.11
2016-2017		82	53.7	0.85	-189.98	-0.02	-7.88	-0.02	-7.77

The estimated breeding values of 16 servicing bulls evaluated in 2016 and revalued in 2017 have significantly changed for the worse: milk yield by 97.1 kg, fat and protein contents by 0.02% and 0.05%, milk fat, and protein yield by 3.97 and 4.76 kg.

Table 3 - Comparative analysis of the limits of the estimated breeding values of bulls revalued according to the BLUP-procedure

Years	The number of reevaluated bulls, animals	BLUP estimate (confidence coefficient over 0.60)									
		Limits of the estimated breeding values									
		Milk yield, kg		Fat, %		Fat, kg		Protein, %		Protein, kg	
		min	max	min	max	min	max	min	max	min	max
2016	16	-598.6	+569.8	-0.06	+0.14	-24.1	+22.1	-0.04	+0.05	-18.3	+20.6
2017		-479.3	+402.3	-0.16	+0.16	-24.8	+26.6	-0.02	+0.02	-20.1	+13.5
2016-2017		-1169.6	+229.1	-0.12	+0.10	-45.1	+12.2	-0.11	+0.04	-40.8	+6.8

Moreover, the limits of the estimated breeding values of servicing bulls in the same period were in the same range. The established bias in the estimates of the breeding value and the indicator of the number of daughters is explained by the fact that in 2017, fewer daughters finished lactation from 16 servicing bulls (4 animals per one tested bull) and, therefore, less number of daughters was involved in assessing the breeding value of servicing bulls according to the quality of offspring. But at the same time, the offspring that completed lactation in 2017 also had a negative estimate for all analyzed indicators of dairy productivity. In 2017, the average confidence coefficient remained at the level of 2016 (0.75, in the range from 0.60 to 0.89)

For the aggregate period, the results of the estimation of bull breeding values were also more negative both for independent years and for the entire period of their use. The analysis of the results obtained for the aggregate estimation period showed that when using information for two adjacent years, firstly, the number of daughters per one estimated bull increases (to 52.4%), and secondly, the average number of effective daughters increases (up to 51.5%) per one tested bull, and thirdly, the average number of effects of HYS factors increases (up to 43.1%), per one servicing bull.

It should also be noted that the above factors ensured a significant increase (by 11%) in the average value of the confidence of the estimated breeding value of 16 servicing bulls, which amounted to 0.85, with fluctuations ranging from 0.73 to 91.

Studies have found that in the procedure for determining the breeding values of bulls, the reliability of the estimates depends on the amount of information on the animal, which is associated with an increase in the length of the evaluation period of their breeding values. The proof of this is the obtaining of a high correlation coefficient between the number of daughters and the reliability of their assessment (+0.78).

It should be noted that when assessing the breeding qualities of bulls in independent years, practically all revalued servicing bulls noted a change in the estimated breeding value both positively and negatively (a rather high variability of bulls' estimates over the years).

In this regard, the rank correlation coefficients between the estimated breeding values of the bulls, obtained in independent years and the aggregate period, have been calculated (Table 4).

The results of the values of the rank correlation coefficients of dairy productivity parameters of daughters, evaluated in different years ("2016" - "2017"), indicate a low level of stability of indicators of their estimated breeding values. Also, a high degree of correlation between the ranks of the bulls was revealed when comparing the breeding values of servicing bulls for independent years and in the aggregate evaluation period. This fact confirms the conclusion that the estimation of the breeding value of bulls should be constantly (at least once a year) adjusted. Moreover, in each subsequent cycle of estimation of the breeding values of bulls, information on the results of previous assessments should be taken into account.

Table 4 - Rank correlation coefficients between estimates of bulls in different years

Breeding traits	Rank correlation coefficients of the estimated breeding values calculated with BLUP method					
	«2016»-«2017»		«2016» - «2016-2017»		«2017» - «2016-2017»	
	animals	correlation	animals	correlation	animals	correlation
Milk yield, kg	16	+0.195	29	+0.721***	40	+0.724***
MFC, %		+0.066		+0.723***		+0.786***
MFY, kg		+0.126		+0.602***		+0.841***
MPC, %		-0.134		+0.761***		+0.797***
MPY, kg		+0.091		+0.610***		+0.729***

Note: * - the coefficient value is reliable at $p>0.95$, ** - the coefficient value is reliable at $p>0.99$, *** - the coefficient value is reliable at $p>0.999$, MFC – Milk fat content, MFY – Milk fat yield, MPC – Milk protein content, MPY – Milk protein yield.

Thus, the results of the estimation of the breeding qualities of bulls obtained in independent years do not allow us to reliably judge their real estimated breeding values, which, in our opinion, is due to an increased risk of fault when choosing the best genotypes for reproduction.

In this regard, to obtain reliable results of the estimated breeding values of bulls, it is necessary to re-evaluate the breeding qualities of servicing bulls at least once a year (it is common to conduct at least 3 estimations per year; ICAR recommendations), with strict regard to the values of previous estimates through the use of the initial array of data to evaluate with an accumulative total.

Conclusion. Based on the research results, it can be stated that as the requirements for the number of daughters of the tested bulls are increased, due to more efficient use of information for two years, when bulls are evaluated using the BLUP method, the accuracy of the forecast of breeding qualities of servicing

bulls is increased, and thereby the proportion or reliably assessed bulls by the quality of the offspring increases. This, in turn, contributes to a more thorough selection of bulls and allows the use of genetically better animals for selective improvement of offspring in the dynamics of subsequent generations.

К.Ж. Жуманов^{1,2}, Т.Н. Карымсаков¹, М.А. Кинеев¹, А.Д. Баймұқанов³

¹«Қазақ мал шаруашылығы және жемшөп өндірісі ғылыми-зерттеу институты» ЖШС, Алматы, Қазақстан;

²«Мал шаруашылығының федералдық ғылыми орталығы – академик Л.К. Эрнст атындағы БМШҒЗИ»
Федералдық мемлекеттік бюджеттік ғылыми мекемесі, Мәскеу, Ресей Федерациясы;

³Ресей мемлекеттік аграрлық университеті – К.А. Тимирязев атындағы Мәскеу ауылшаруашылық академиясы, Мәскеу, Ресей

VLUP ӘДІСІ НЕГІЗІНДЕ ГОЛШТИН ҚАРА-АЛА БҰҚАСЫНЫҢ ТҰҚЫМДЫҚ ҚҰНДЫЛЫҒЫН ТҰҚЫМЫНЫҢ САПАСЫ БОЙЫНША БАҒАЛАУ

Аннотация. Зерттеудің өзектілігі жануарлардың тұқымдық құндылығын бағалаудың әлемдік тәжірибесінде, атап айтқанда, VLUP математикалық әдісін қолдана отырып, жаңа және қолданыстағы цифрлық технологияларды әзірлеу арқылы Қазақстандағы сүтті мал шаруашылығындағы асыл тұқымды жұмыстарды жүргізуді жетілдіру қажеттілігіне байланысты болып келеді.

2016 жылы бағаланған және 2017 жылы қайта бағаланған 16 өндірушінің асыл тұқымдық қасиетінің көрсеткіші нашар жағына өзгергені байқалды: 97,1 кг-ға сауу, 0,02 және 0,05%-ға май мен ақуыз, 3,97 және 4,76 кг-ға сүт майы мен ақуыздың шығуы. Асыл тұқымдық құндылықты бағалаудың белгіленген ығысуы 2017 жылы 16 өндірушіден сауылымды аз мөлшерде (бір тексерілетін өндірушіге есептегенде 4 бас малға) аяқтаған және тұқым сапасы бойынша өндірушілердің асыл тұқымдық құндылығын бағалауға аз аналық қатысты.

Бірақ 2017 жылы лактацияны аяқтаған тұқым сүт өнімінің талданатын барлық көрсеткіштері бойынша теріс бағаланды. Орташа сенімділік коэффициенті 2017 жылы 2016 жылдың деңгейінде қалды (0,75, 0,60-тан 0,89-ға дейінгі диапазонда).

Жиынтық кезең ішінде бұқалардың асыл тұқымдық құндылығының индексін бағалау нәтижелері жеке алынған жылдарда да, оларды пайдаланудың барлық кезеңінде де теріс мәнге ие болды. Бағалаудың жиынтық кезеңінде алынған нәтижелерді талдау қатар екі жыл ішінде ақпаратты пайдаланған кезде, біріншіден, бағаланатын бір өндірушіге (52,4%-ға дейін) аналықтың саны артатынын, екіншіден, тексерілетін бір өндірушіге тиімді аналықтардың орташа саны (51,5%-ға дейін) көбейетінін және үшіншіден, тексерілетін бір өндірушіге шаққанда «HYS» фактор эсерлерінің орташа саны (43,1%-ға дейін) артатынын көрсетті.

Тұқымдық бұқалардың асыл тұқымдық сапасын анықтау рәсімі кезінде алынған бағаның дұрыстығы мал туралы ақпарат санына байланысты екені айқындалды, бұл олардың асыл тұқымдық құндылығын бағалау кезеңі ұзақтығының ұлғаюына байланысты. Бұған аналық саны мен оларды бағалаудың (reliability) дұрыстығы (+0,78) арасындағы жоғары корреляция коэффициентінің алынғаны дәлел. Әр жылдары бұқаның асыл тұқымдық сапасын бағалау кезінде барлық қайта бағаланған өндірушілерде асыл тұқымдық құндылық индексінің оң және теріс жағынан (бұқаларды жылдар бойынша бағалау айтарлықтай жоғары ауытқыған) өзгергенін атап өту қажет.

Әр жылдары бағаланған (2016-2017) өндірушілердің сүт өнімі көрсеткіштерінің рангтық корреляция коэффициенттерінің алынған нәтижесі олардың асыл тұқымдық құндылығын бағалау көрсеткіші тұрақтылығының төмен деңгейде екендігін көрсетеді. Бұл ретте жекелеген жылдардағы және бағалаудың жиынтық кезеңінде тұқымдық бұқалардың асыл тұқымдық құндылығының индексін салыстыру кезінде бұқа дәрежесінің өзара байланысының жоғары дәрежесі анықталды. Бұл факт бұқалардың асыл тұқымдық құндылығын бағалау үнемі (аз дегенде жылына бір рет) түзетілуі тиіс деген қорытындыны растайды. Бұл ретте бұқалардың асыл тұқымдық құндылығын бағалаудың әрбір келесі кезеңінде бұрын жүргізілген бағалау қорытындысы туралы ақпарат ескерілуі тиіс.

Осылайша жекелеген жылдары алынған бұқаның асыл тұқымдық сапасын бағалау нәтижелері олардың асыл тұқымдық құндылығын бағалау туралы нақты айтуға мүмкіндік бермейді, біздің ойымызша, бұл өсімін молайтуға арналған үздік генотиптерді таңдаудағы қателік жасау қаупінің артуына байланысты. Осыған қатысты бұқалардың асыл тұқымдық құндылығын бағалаудың шынайы нәтижелерін алу, алдыңғы баға көрсеткішін жинақталатын нәтижемен бағалау үшін деректердің бастапқы жиынын пайдалану арқылы қатаң ескеру негізінде кем дегенде жылына бір рет тұқымдық сапасын қайта бағалау қажет (жылына аз дегенде 3 бағалаған жөн); ICAR ұсыныстары).

Түйін сөздер: бұқа, тұқымдық құндылық, сүт өнімділігі, деректілік, корреляция, VLUP әдісі.

К. Ж. Жуманов^{1,2}, Т.Н. Карымсаков¹, М.А. Кинеев¹, А.Д. Баймуканов³

¹ТОО «Казахский научно-исследовательский институт животноводства и кормопроизводства», Алматы, Казахстан;

²Федеральное государственное бюджетное научное учреждение «Федеральный научный центр животноводства – ВИЖ имени академика Л.К. Эрнста», Российская Федерация,

Московская область, г. о. Подольск, п. Дубровицы;

³Российский государственный аграрный университет – Московская сельскохозяйственная академия им. К.А. Тимирязева, Москва, Россия

ОЦЕНКА ПЛЕМЕННОЙ ЦЕННОСТИ БЫКОВ-ПРОИЗВОДИТЕЛЕЙ ГОЛШТИНСКОЙ ЧЁРНО-ПЁСТРОЙ ПОРОДЫ ПО КАЧЕСТВУ ПОТОМСТВА С ПРИМЕНЕНИЕМ МЕТОДА BLUP

Аннотация. Актуальность выполненных исследований заключается в необходимости усовершенствования ведения племенной работы в молочном скотоводстве Казахстана посредством разработки новых и адаптации существующих в мировой практике цифровых технологий оценки племенной ценности животных, в частности с применением математического метода BLUP.

Установлено, что показатели племенных качеств 16 производителей, оценённых в 2016 и переоценённых в 2017 годах, существенно изменились в худшую сторону: удой на 97,1 кг, содержание жира и белка на 0,02 и 0,05%, выход молочного жира и белка на 3,97 и 4,76 кг. При этом лимиты индексов племенной ценности производителей в этот же период был в том же диапазоне. Установленное смещение оценки племенной ценности и показателя численности дочерей объясняется тем, что в 2017 году от 16 производителей закончило лактацию меньшее количество дочерей (на 4 головы в расчёте на одного проверяемого производителя) и тем самым в оценке племенной ценности производителей по качеству потомства участвовало меньшее количество дочерей. Но при этом потомство, закончившее лактацию в 2017 году, также имело отрицательную оценку по всем анализируемым показателям молочной продуктивности. Средний коэффициент достоверности в 2017 году оставался на уровне 2016 года (0,75, в диапазоне от 0,60 до 0,89)

За совокупный период результаты оценки индексов племенной ценности быков имели также отрицательные значения как за отдельно взятые годы, так и за весь период их использования. Анализ полученных результатов за совокупный период оценки показал, что при использовании информации за два смежных года, во-первых, увеличивается число дочерей на одного оцениваемого производителя (до 52,4%), во-вторых, повышается среднее число эффективных дочерей (до 51,5%) на одного проверяемого производителя, и в-третьих, увеличивается среднее число эффектов факторов «HYS» (до 43,1%), в расчёте на одного проверяемого производителя.

Установлено, что при процедуре определения племенных качеств быков-производителей, достоверность полученных оценок зависит от количества информации о животном, что, очевидно, связано с увеличением продолжительности периода оценки их племенной ценности. Доказательством этому служит получение высокого коэффициента корреляции между численностью дочерей и достоверностью (reliability) их оценки (+0,78). Необходимо отметить, что при оценке племенных качеств быков в отдельные годы, практический у всех переоценённых производителей отмечено изменение индексов племенной ценности как в положительную, так и в отрицательную стороны (достаточно высокая вариабельность оценок быков по годам).

Полученные результаты значений коэффициентов ранговой корреляции показателей молочной продуктивности дочерей производителей, оценённых в разные годы («2016г»-«2017г»), свидетельствуют о низком уровне стабильности показателей оценок их племенной ценности. При этом была выявлена высокая степень взаимосвязи рангов быков при сравнении индексов племенной ценности производителей за отдельные годы и в совокупный период оценки. Этот факт чётко подтверждает вывод о том, что оценка племенной ценности быков должна постоянно (хотя бы раз в год) корректироваться. При этом в каждом последующем цикле оценки племенной ценности быков должна учитываться информация об итогах ранее проведённых оценок.

Таким образом, результаты оценки племенных качеств быков, полученные в отдельные годы, не позволяют достаточно надёжно судить об их реальной оценке племенной ценности, что, по нашему мнению, происходит из-за увеличения риска ошибки при выборе лучших генотипов для воспроизводства. В этой связи, для получения достоверных результатов оценки племенной ценности быков следует проводить переоценку племенных качеств производителей, как минимум, один раз в год (принято проводить, минимум 3 оценки в год; рекомендации ICAR), со строгим учётом показателей предыдущих оценок через использование исходного массива данных для оценки с накапливающим итогом.

Ключевые слова: быки-производители, племенная ценность, молочная продуктивность, достоверность, корреляция, метод BLUP.

Information on authors

Zhumanov Kanat Zheksembekovich, Master in veterinary science, Head of the Department of Breeding and Cattle Breeding of the Kazakh Research Institute of Animal Breeding and Fodder Production, Tel: +77073088082, E-mail: kano_zh@mail.ru, <https://orcid.org/0000-0001-8400-4073>;

Karymsakov Talgat Nikolaevich, Candidate of agricultural sciences, deputy general director of the Kazakh Research Institute of Animal Breeding and Fodder Production. Tel: +7 7014087167. E-mail: kartalगत@mail.ru, <https://orcid.org/0000-0003-4398-8840>;

Kineev Marat Aidarovich, Doctor of Agricultural Sciences, scientific adviser of the Kazakh Research Institute of Animal Breeding and Fodder Production. Tel: +77058732834, E-mail: k_maratAK@mail.ru, <https://orcid.org/0000-0003-2170-6160>;

Baimukanov Aidar Dastanbekuly, master degree student of the Department of Breeding and Feeding of Farm Animals, Faculty of Zootechnics and Biology, Russian State Agrarian University - Moscow Agricultural Academy named after K.A. Timiryazev, Moscow, Russia E-mail: aidartaidar98@mail.ru, <https://orcid.org/0000-0001-9669-864X>.

REFERENCES

[1] Yelemesov K.Ye., Baimukanov A. D. (2000) The estimated breeding value of servicing bulls of domestic breeds by offspring quality using the BLUP method. Bulletin of the National Academy of Sciences of the Republic of Kazakhstan. ISSN 1991–3494. Volume 3, Number 385 (2020), 51 – 59. <https://doi.org/10.32014/2020.2518-1467.69>

[2] Baimukanov D.A., Abugaliyev S.K., Seidaliyev N.B., Chindaliyev A.E., Dalibayev E.K., Zhamalov B.S., Muka Sh.B. (2019). Productivity and estimated breeding value of the dairy cattle gene pool in the Republic of Kazakhstan. Bulletin of the National Academy of Sciences of the Republic of Kazakhstan. Volume 2, Number 378 (2019), 14–28. <https://doi.org/10.32014/2019.2518-1467.36>. ISSN 2518-1467 (Online), ISSN 1991-3494 (Print).

[3] Baimukanov D.A., Seidaliyev N.B., Alentayev A.S., Abugaliyev S.K., Semenov V.G., Dalibayev E.K., Zhamalov B.S., Muka Sh.B. (2019) Improving the reproductive ability of the dairy cattle. Reports of the National Academy of Sciences of the Republic of Kazakhstan. Volume 2, Number 324 (2019), 20–31. <https://doi.org/10.32014/2019.2518-1483.33>. ISSN 2518-1483 (Online), ISSN 2224-5227 (Print).

[4] Henderson C.R. (1984) Application of linear models in Animal Breeding. University of Guelph. 544 p.

[5] Henderson C.R. (1989) Statistical methods in Animal Improvement. Historical overview. Advances in statistical methods for Genetic Improvement of Livestock. Springer. P. 1-14.

[6] Merkur'yeva E.K., Shangin-Berezovsky G.N. (1983) Genetics with the basics of biometrics [*Genetika s osnovami biometrii*]. Moscow. Publisher Kolos. 399 p. (in Russ.).

[7] Plokhinsky N.A. (1969) Biometrics Guide for Livestock Specialists. Moscow [*Rukovodstvo po biometrii dlya zootekhnikov*]. Kolos publishing house. 1969. 340 p. (in Russ.).

[8] Ruzsky S.A. (1977) Breeding work in cattle breeding [*Plemennoye delo v skotovodstve*]. Textbook. 2nd ed., Revised and supplemented. Moscow. Kolos. 320 p. (in Russ.).

[9] Bourdon R.M. (1998) Short comings of current genetice valuati on systems. J.Anim. Sci. № 76. P. 2308-2323.

[10] Drue T., Misztal I., Duangjinda M., Reverter A., Gengler N. (2001) Estimation of genetic covariances with Method R. J. Anim. Sci. №79. P.605-615. R / T. Druet I. Misztal, M. Duangjinda, A. Reverter, N. Gengler // J. Anim.Sci. 79:605-615. 2001.

[11] Falconer D.S. (1988) Introduction to Quantitative Genetics. New York. 433

[12] Van Vleck D. (1974) Notes of theory and application of selection principles for the genetic improvement of animals. 287 p.

[13] Karymsakov T.N., Abugaliyev S.K., Baimukanov D.A. (2019) Evaluation of the breeding value of sires by genome analysis. Agrarian science 2019; (10): 40–42. <https://doi.org/10.32634/0869-8155-2019-332-9-40-42>. ISSN 0869–8155 (Print). ISSN 2686–701X (Online).

[14] Kuznetsov V.M. (1995) Genetic Evaluation of Dairy Cattle by BLUP method [*Geneticheskaya otsenka molochnogo skota metodom BLUP*]. Zootechnics. No. 11. p. 8-15. (in Russ.).

[15] Kharitonov S.N., Yanchukov I.N., Ermilov A.N., Ermilov A.A. (2015) Modern problems of the estimated breeding values of servicing bulls [*Sovremennyye problemy otsenki plemennykh kachestv bykov proizvoditeley*]. Genetic resources of Moscow on breeding. Moscow. Publishing house OAO Moskovskoye in breeding. p. 14-17. (in Russ.).

UDC 678.5

K.R. Uteulin, K.Z.Zambakin

The Republican State Institution “Institute of Plant Biology and Biotechnology” The Committee of Science.
The Ministry of Education and Science of the Republic of Kazakhstan, Almaty, Kazakhstan.
E-mail: gen_uteulink@mail.ru

ON THE NEED TO DEVELOP TECHNOLOGIES FOR PRODUCING BIOPLASTICS IN KAZAKHSTAN

Abstract. This article is published with a purpose to draw attention to the need to initiate in Kazakhstan the development of technologies for producing bioplastics from Kazakhstan’s own renewable plant resources.

Every year, Kazakhstan generates hundreds of thousands of tons of plastic waste based on synthetic polymers traditionally produced from petrochemical raw material. Among them are bottles, packaging and bags. For example, in 2019 alone, plastic waste amounted to over 480 thousand tons. 15 companies, including two plastic processing plants, are not capable to cope with this amount of garbage. More than 18 million plastic bags are discarded in Kazakhstan every day, contaminating the environment.

Since only about 9% of the plastic produced is recycled, the remaining part either contaminates the environment or is damped where the complete decomposition takes up to 500 years, releasing toxic substances into the soil in the mean time.

The production of bioplastics and bioplastics-based products that will decompose in a short time (few months) will reduce the use of synthetic plastic products the decomposition of which is extremely slowly from 100 up to 500 years. Petroleum-based plastic is a real threat as a source of environmental pollution. Kazakhstan is taking measures to reduce environmental pollution. Starting in 2025 it is planned to introduce a complete ban on the realization of petroleum-based food packaging (bags).

It is necessary to develop technologies for producing biodegradable polymers from renewable biological resources to replace petroleum-based plastic, reduce environmental pollution and increase global sustainability.

There is a need for initiation of the research work on bioplastics in Kazakhstan.

Keywords: bioplastics, natural polymers, natural rubber.

Main part. Problem. Hundreds of thousands of tons of plastic waste based on synthetic polymers traditionally made from raw materials based on petroleum products accumulate in Kazakhstan annually.

These are bottles, packaging and bags. For example, in 2019 alone, plastic waste amounted to over 480 thousand tons. 15 companies, including two plastic processing plants, cannot cope with this amount of garbage. Every day in Kazakhstan, more than 18 million plastic bags are thrown, polluting the environment [1].

Since only about 9% of the plastic produced goes into recycling, the rest either pollutes the environment or settles in landfills, where its complete decomposition can take up to 500 years, and toxic substances will be released into the soil.

The main problem with the use of products made of synthetic polymeric materials is their very slow decomposition under natural conditions (from one hundred to 500 years). Oil based plastic is a real threat as a source of environmental pollution. Kazakhstan is taking measures to reduce environmental pollution.

Thus, the Ministry of Ecology, Geology and Natural Resources of Kazakhstan, the National Chamber of Entrepreneurs "Atameken" and the Association of Environmental Organizations of Kazakhstan concluded a memorandum of cooperation on the introduction of paid use of plastic bags. The main goal of

the adopted memorandum is to reduce the use of plastic bags and the production of environmentally friendly types of packaging (biodegradable plastics).

It should be noted that the international community is actively working to reduce the output of synthetic plastic products. To date, more than 40 countries at different stages have introduced a ban on the use of plastic bags. For example, in Germany, Denmark, the Czech Republic, and Uzbekistan, free sale of plastic bags in retail trade is banned, and in the USA, China, Italy, Australia, Pakistan, Georgia, Kenya, a complete ban on the use, sale, production and import of plastic bags has been introduced.

Since 2025, Kazakhstan will introduce a complete ban on the sale of oil-based food packaging (bags) [2].

It is necessary to develop technologies for producing biodegradable polymers from renewable biological resources to replace petroleum-based plastic with them, reduce environmental pollution and increase global sustainability.

The main advantage of bioplastics is its ability to decompose in a short period of time (weeks and months), while the decomposition of synthetic plastic requires hundreds of years [3].

In this regard, research is also being initiated in Kazakhstan aimed at developing technologies for obtaining new bioplastics from Kazakhstan's renewable plant resources.

Biodegradable polymers are polymers that retain performance over a period of consumption and then decompose under the influence of environmental factors into water and carbon dioxide, humic substances and biomass. Thus, a natural cycle of substances is carried out, capable of maintaining the ecological balance in nature [4]

Biodegradable polymers have advantages:

- the possibility of processing, as well as petroleum-based polymers, on standard equipment;
- resistance to decomposition under ordinary conditions;
- fast and complete degradability when specially created or natural conditions - the absence of problems with waste disposal;
- independence from petrochemical raw materials.

Biodegradable plastics are divided into four groups.

The first group is natural polymers isolated from biomass: starch, cellulose, protein, glycogen, inulin, natural rubber.

The advantage of natural polymers is that the resources of the feedstock are constantly renewable.

The second group consists of polymers produced by microorganisms during their life (PHA polyhydroxyalkanoates - derivatives of polyoxybutyric acid). The most promising polymer of this group at present is poly-3-hydroxybutyrate, or polyhydroxybutyrate (PHB). In nature, this polymer is synthesized by certain types of microorganisms and plays the role of an intracellular energy reserve, like glycogen and polyphosphates in other microorganisms. Polymer located in the cytoplasm of microorganism cells in the form of granules and usually accounts for more than 40% of their weight in the dry state [5].

Since PHA is biodegradable and does not harm living tissues, it is often used in medicine as absorbable suture threads, dressings and tampons, plates and rods in orthopedics [6, 7].

The third group includes polymers artificially synthesized from natural monomers, for example, PLA polylactides.

Products made of polylactide (PLA), a transparent thermoplastic that is a product of polycondensation of lactic acid, decompose in compost within one months and a little longer in seawater. An important advantage of a submarine is the possibility of processing it on traditional equipment. Disposable dishes, films, fibers, and implants for medicine are formed from PLA [8].

The main producer of polylactides is the company RURAC (Netherlands).

When you add the appropriate plasticizer, the PLA becomes elastic and can compete in properties with polyethylene (PE), polypropylene (PP) or plasticized polyvinyl chloride. The service life of the polymer increases with a decrease in the size of the monomer unit in its composition, as well as after orientation drawing, causing an increase in the modulus of elasticity and thermal stability of the submarine. By fermenting corn dextrose, the American company Cargill Inc. mastered the production of submarines under the Eco-Pla trademark, sheets of which are comparable in impact resistance to

polystyrene (PS). Films have high strength, transparency, gloss, low coefficient of friction and good weldability.

However, the PLA is not without flaws, the main of which is the ability to swelling and dissolution during prolonged contact with water. Moreover, the higher the temperature, the faster these processes occur. Another drawback holding back the widespread adoption of PLA as a polymer domestic and general technical purpose, is its high cost [6].

The fourth group consists of traditional synthetic plastics with biodegradable additives introduced into them.

Currently relevant task is the creation of compositions (mixtures) from synthetic (obtained mainly from oil) and natural (organic and inorganic) materials - BSPM, in which the continuous (matrix) phase is a synthetic polymer.

The first stage of biodegradation is the formation of microcracks and the subsequent destruction of products into fragments. The mechanism of these processes is based on photodegradation of system components under the influence of ultraviolet (UV) radiation with the formation of radicals, which, in turn, activate photooxidative processes in PM [9].

Then the fragments are exposed to microorganisms, enzymes [6].

Synthetic polymers, that is, based on petroleum products, include: polyethylene, phenol-formaldehyde polymers, synthetic fibers, synthetic rubbers [10].

The problem of replacing plastic based on synthetic polymers with bioplastics is an international problem. Thus, according to global market forecasts, in 2020 bioplastics will make up 5% of all plastics produced, and in 2030 - 40% of all plastics produced. Ceresana predicts that by 2020 the global bioplastics market will be \$ 5.8 billion [11].

Currently, bioplastics account for approximately 1% of 335 million tons of plastics produced annually.

According to the latest data from the European Bioplastics Institute and the nova-Institute Research Institute (Hürth, Germany), which are leading organizations in the field of biopolymer research, global bioplastics production capacity will increase from approximately 2.11 million tons in 2018. up to approximately 2.62 million tons in 2023 [12].

The disadvantages of biopolymers should also be noted:

- high cost (so far an average of 2-5 euros per 1 kg) ;
- many of the bioplastics are inferior to conventional plastics in mechanical properties, i.e. they are not strong and tough;
- many of the bioplastics are inferior to petroleum-based plastics in their barrier properties to oxygen, carbon dioxide and water vapor, which can adversely affect a packaged food product.

At the same time, numerous publications indicate an ongoing search for promising developments in the production of biodegradable materials [13].

Thus, research is needed to address the disadvantages of biodegradable polymeric materials.

For example, it is necessary to modify the technology for bioplastics based on the natural polymer of starch. The main sources of starch are crops - potatoes, corn, wheat, barley.

Starch is fully biodegradable, renewable and has a low cost [14].

Starch is an inexpensive and affordable substance that decomposes under various conditions the environment. Its production exceeds current market needs.

USA and Europe. The leading manufacturers of starch-based biopolymers are: the Italian company Novamont, the Dutch company Rodenburg Polymers [15]. Overproduction of potato, a source of starch, was also noted in Kazakhstan [16].

Starch ($C_6H_{10}O_5$)_n is a mixture of amylose polysaccharides and amylopectin, monomer of which is alpha glucose. Amylose is a linear polymer, amylopectin is a branched polymer. The content of amylose and amylopectin in starch varies and largely depends on the source of starch [17].

The good compatibility of starch with plasticizers is of great interest for the production of bioplastics.

Plasticizers are substances that are introduced into the composition of polymeric materials to give (or increase) elasticity or plasticity, to improve technological and operational properties.

A review of the literature indicates that the final properties of starch bioplastics can be improved by using various plasticizers, fillers, and also by changing the source of starch [18].

That is, further, new studies of starchy bioplastics compositions are needed.

Composite material is a multicomponent material, consisting, as a rule, of a plastic base (matrix), supplemented with fillers with high strength, rigidity, etc. By varying the composition of the plastic base and filler, their ratio, they get a wide range of materials with the necessary properties.

Promising technologies aimed at the inclusion of latex rubber plants (milk juice with colloidal rubber particles) in the composition of starchy bioplastics to increase its elasticity and strength. Due to its plasticity, elasticity, affordability and low cost, natural rubber is a promising agent for improving various bioplastics.

Similar work was carried out in Thailand and the USA with PHBV (Poly (3-hydroxybutyrate-co-3-hydroxyvalerate)), as a result, the plasticity and hardness of this bioplastics were improved [19,20].

Natural rubber is a high molecular weight hydrocarbon (C₅H₈)_n, a cis polymer of isoprene; contained in the latex of the tropical tree of Hevea (Hevea brasiliensis), in the roots of the Kazakhstan Dandelion kok-sagyz (Taraxacum kok-saghyz) and other rubbery plants [21].

The most widespread use of natural rubber is the production of rubber [22].

However, a new application of natural rubber is currently being discovered - the inclusion of natural rubber in bioplastics to improve its performance [20].

Conclusion. Oil-based plastic is a real threat as a source of environmental pollution in Kazakhstan. In this regard, research is also being initiated in Kazakhstan aimed at developing technologies for obtaining new bioplastics from Kazakhstan's renewable plant resources.

It is necessary to develop technologies for producing bioplastics from natural polymers that are biodegradable for several months to replace synthetic plastic with them.

The critical points, alternative ways of implementing the bioplastics problem in Kazakhstan are as follows.

It is necessary to strengthen the strength and elasticity of bioplastics.

Promising solutions. Choose the best composition, such as starch and adequate plasticizers and additives. A promising way to improve the strength and ductility of bioplastics is to include natural rubber in its composition.

It is necessary to reduce the cost of bioplastics, to ensure import substitution. Cheaper bioplastics can be achieved by using cheap ingredients. Use of waste, waste or untreated materials is possible.

It is necessary to narrow the gap between bioplastics research and the market through the collaboration of scientists with commercial enterprises producing and selling bioplastics.

К.Р. Утеулин, К.Ж. Жамбакин

«Биология және өсімдіктер биотехнологиясы институты» республикалық мемлекеттік мекемесі,
ҚР Білім және ғылым министрлігі, Алматы, Қазақстан

ҚАЗАҚСТАНДА БИОПЛАСТИКТИ АЛУ ТЕХНОЛОГИЯСЫН ӘЗІРЛЕУ ҚАЖЕТТІЛІГІ ТУРАЛЫ

Аннотация. Ұсынылған аналитикалық шолу Қазақстанға жекеменшік қазақтандық жаңартылатын өсімдік ресурстарынан биопластик алу технологиясын әзірлеуді бастау қажеттілігіне назар аудару мақсатында жарияланды.

Жыл сайын Қазақстанда мұнай өнімдері негізінде шикізаттан дәстүрлі дайындалған синтетикалық полимерлер арқылы жүздеген мың тонна пластик қалдықтар жиналады. Бұл қалдықтар – бөтелке, қаптама және пакеттер. Мысалы, 2019 жылғы пластик қоқысы 480 мың тоннадан асты. 15 компания, оның ішінде пластикті қайта өңдейтін екі зауыт қоқыс мөлшерін игере алмайды. Қазақстанда күн сайын қоршаған ортаны ластайтын 18 миллионнан астам пластикалық пакет шығарылады.

Қайталама өңдеуге өндірілетін пластиктің 9%-ға жуығы ғана келіп түсетіндіктен, қалған бөлігі қоршаған ортаны ластайды немесе қоқыс тастайтын жерде тұрады, онда толық ыдырау үдерісі 500 жылға дейін созылуы мүмкін, бұл ретте топыраққа улы заттар бөлінеді.

Қазақстанда биопластика өндірісін және соның негізінде қысқа мерзімде (айларда) ыдырайтын бұйымдарды өндіру ұйымдары синтетикалық пластиктен жасалған бұйымдарды пайдалануды 100-ден 500 жылға дейін өте баяу ыдырату жағдайын қысқарта алады. Мұнай өнімдерінің негізінде пластик қоршаған ортаны ластаудың көзі ретінде нақты қауіп-қатерлерді келтіреді. Қазақстанда қоршаған ортаны ластану мөлшерін қысқарту жөнінде шаралар қабылдануда. Осылайша 2025 жылдан бастап мұнай негізіндегі тағамдық қаптаманы (пакеттерді) сатуға толық тыйым салу жоспарланып отыр. Жаңартылатын биологиялық ресурстардан биологиялық ыдырайтын полимерлерді мұнай негізіндегі пластиктерді ауыстыру, қоршаған ортаның ластануын азайту және жаһандық тұрақтылықты арттыру үшін айырып алу технологияларын әзірлеу қажет.

Биоалуантүрлілік пластиктер төрт топқа бөлінеді.

Бірінші топ – биомассадан бөлінген табиғи полимерлер: крахмал, целлюлоза, ақуыз, гликоген, инулин, табиғи каучук. Табиғи полимерлердің артықшылығы – бастапқы шикізат ресурстары үнемі жаңарып отырады.

Екінші топ – өмір сүру барысында микроорганизмдер өндіретін полимерлер (полигидроксиалканоаттар РНА – полиоксимаид қышқылының туындылары). Қазіргі уақытта осы топтың ең перспективті полимері поли-3-оксидутират немесе полигидроксибутират (ПГБ) болып саналады. Табиғатта бұл полимер микроорганизмдердің кейбір түрлерімен синтезделген және басқа микроорганизмдердегі гликоген мен полифосфат сияқты жасушаішілік энергетикалық резерв рөлін атқарады. Полимер микроағзалар жасушаларының цитоплазмасында түйіршіктер түрінде болады және әдетте құрғақ күйінде олардың салмағының 40%-дан астамын құрайды.

РНА биологиялық ыдырайтын және тірі тіндерге зиян келтірмейтіндіктен оны медицинада жиі соратын тігістік жіптер, таңғыштар мен тампондар, пластиналар мен ортопедиядағы өзек ретінде пайдаланады.

Үшінші топ – табиғи мономерлерден жасанды синтезделген полимерлер, мысалы, PLA полилактидтер.

Полилактидтен (АЖЖ) жасалған бұйымдар – сүт қышқылының поликонденсациясының өнімі – мөлдір термопласт бір ай ішінде компоста және теңіз суында одан біраз ұзағырақ ыдырайды. АЖЖ-ның маңызды артықшылығы оны дәстүрлі жабдықта қайта өңдеу мүмкіндігі болып саналады. ПЛ-дан бірреттік ыдыс, пленка, талшықтар, медицина үшін имплантаттар қалыптасады.

Төртінші топ – дәстүрлі синтетикалық пластиктер, оларға енгізілген биологиялық бұзғыш қоспалар.

Синтетикалық (негізінен мұнайдан алынған) және табиғи материалдардан жасалған қоспалар жасалады, оларда үздіксіз матрицалық фаза синтетикалық полимер болып саналады.

Синтетикалық полимерлерге мыналар жатады: полиэтилен, феноло-формальдегидті полимерлер, синтетикалық талшықтар, синтетикалық каучуктар.

Қазақстанда биопластиканың ғылыми-зерттеу жұмыстарына бастамашылық жасау қажет.

Түйін сөздер: биопластик, табиғи полимерлер, табиғи каучук.

К.Р.Утеулин, К.Ж. Жамбакин

Республиканское государственное учреждение «Институт биологии и биотехнологии растений» Комитет Науки. Министерство образования и науки Республики Казахстан. Алматы. Казахстан

О НЕОБХОДИМОСТИ РАЗРАБОТОК ТЕХНОЛОГИЙ ПОЛУЧЕНИЯ БИОПЛАСТИКА В КАЗАХСТАНЕ

Аннотация. Настоящий аналитический обзор публикуется с целью обратить внимание на необходимость инициации в Казахстане разработок технологий получения биопластика из собственных, казахстанских возобновляемых растительных ресурсов.

Ежегодно в Казахстане скапливаются сотни тысяч тонн пластиковых отходов на основе синтетических полимеров, традиционно изготовленных из сырья на основе нефтепродуктов. Это бутылки, упаковки и пакеты. К примеру, только в 2019 году мусор пластика составил свыше 480 тысяч тонн. 15 компаний, в том числе два завода по переработке пластика не справляются с этим количеством мусора. Каждый день в Казахстане выбрасывается более 18 млн пластиковых пакетов, загрязняя окружающую среду.

Поскольку во вторичную переработку поступает лишь около 9% производимого пластика, остальная часть либо загрязняет окружающую среду, либо оседает на свалках, где его полное разложение может занять до 500 лет, при этом в почву будут выделяться токсичные вещества.

Организация в Казахстане производства биопластика и на его основе изделий, разлагаемых в короткий срок (месяцы), обеспечит сокращение использования изделий из синтетического пластика, разлагаемых крайне медленно от 100 до 500 лет. Пластик на основе нефтепродуктов составляет реальную угрозу как источник загрязнения окружающей среды. В Казахстане принимаются меры по сокращению загрязнений окружающей среды. Так, планируется с 2025 года ввести полный запрет на реализацию пищевой упаковки (пакетов) на основе нефти. Необходима разработка технологий получения биоразлагаемых полимеров из возобновляемых биологических ресурсов для замены ими пластика на нефтяной основе, уменьшения загрязнения окружающей среды и повышения глобальной устойчивости.

Биоразлагаемые пластики делятся на четыре группы.

Первая группа – это природные полимеры, выделенные из биомассы: крахмал, целлюлоза, белок, гликоген, инулин, натуральный каучук. Преимущество природных полимеров в том, что ресурсы исходного сырья постоянно возобновляемы.

Вторая группа – полимеры, производимые микроорганизмами в ходе своей жизнедеятельности (полигидроксиалканоаты PHA - производные полиоксимасляной кислоты). Наиболее перспективным в настоящее время полимером этой группы является поли-3-оксибутират, или полигидроксибутират (ПГБ). В природе этот полимер синтезируется некоторыми видами микроорганизмов и играет роль внутриклеточного энергетического резерва, подобно гликогену и полифосфатам в других микроорганизмах. Полимер находится в цитоплазме клеток микроорганизмов в виде гранул и обычно составляет более 40 % от их веса в сухом состоянии.

Поскольку PHA – биоразлагаемый и не вредит живым тканям, его часто используют в медицине в качестве рассасывающихся шовных нитей, повязок и тампонов, пластин и стержней в ортопедии.

Третья группа – полимеры, искусственно синтезированные из природных мономеров, например, PLA полилактиды.

Изделия из полилактида (ПЛА) – прозрачного термопласта, который является продуктом поликонденсации молочной кислоты, разлагаются в компосте в течение одного

месяца и немногим дольше в морской воде. Важным достоинством ПЛА является возможность его переработки на традиционном оборудовании. Из ПЛА формуют одноразовую посуду, пленки, волокна, имплантаты для медицины.

Четвертая группа – традиционные синтетические пластики с введенными в них биоразрушающими добавками.

Создаются смеси из синтетических (полученных главным образом из нефти) и природных материалов, в которых непрерывной, матричной фазой является синтетический полимер.

К синтетическим полимерам относятся: полиэтилен, феноло-формальдегидные полимеры, синтетические волокна, синтетические каучуки.

Необходима инициация научно-исследовательских работ биопластика в Казахстане.

Ключевые слова: биопластик, природные полимеры, натуральный каучук.

Information on authors:

Kairat Rizabekovich Uteulin, First co-author for correspondence. Associate Professor. Doctor of Biological Sciences. Head of Laboratory. Republican State Enterprise «Institute of Plant Biology and Biotechnology», Committee of Sciences, Ministry of Education and Science of the Republic of Kazakhstan, Almaty, Kazakhstan, e.mail: gen_uteulink@mail.ru, <https://orcid.org/0000-0002-5459-0902>;

Kabyl Zhambakin, Professor. Academician of the National Academy of Sciences of the Republic of Kazakhstan. Director General of Republican State Enterprise «Institute of Plant Biology and Biotechnology», Committee of Sciences, Ministry of Education and Science of the Republic of Kazakhstan, Almaty, Kazakhstan, zhambakin@gmail.com, <https://orcid.org/0000-0001-5243-145X>

REFERENCES

- [1] The problem of plastic processing in Kazakhstan.youtube.com; Recycling plastic in Kazakhstan. [Problema pererabotki plastika v Kazakhstane.youtube.com; Pererabotka plastika v Kazakhstane]. youtube.com. (In Russ.).
- [2] https://tengrinews.kz/kazakhstan_news/poetapnyiy-zapret-realizatsiyu-polietilenoviyh-paketov-379662. (In Russ.).
- [3] Krutko ET, Prokopchuk N. R., Globa A. I. (2014). Technology of biodegradable polymer materials. Minsk. [Tekhnologiya biorazlagayemykh polimernykh materialov. Minsk] 106 p. (In Russ.).

- [4] Kolybaba M., Tabil L. G., Panigrahi S., Crerar W. J., Powell T., Wang B. (2030). Biodegradable Polymers: Past, Present and Future. The Society for engineering in agricultural, food, and biological systems. 25 p.
- [5] Iordansky A.L., Pankova Yu.N., Kosenko R.Yu., Olkhov A.A. (2005). Water transport as a structurally sensitive process characterizing the morphology of biodegradable polymer systems. [Iordanskiy A.L., Pankova YU.N., Kosenko R.YU., Ol'khov A.A. (2005). Transport vody kak strukturno-chuvstvitel'nyy protsess, kharakterizuyushchiy morfologiyu biodegradabel'nykh polimernykh sistem] Chemical and biological kinetics. New Horizons. - M.: Chemistry. Vol 1. P. 640–657. (In Russ.).
- [6] Olkhov A.A., Jordan A.L., Zaikov G.E. (2014). Based Bioplastics thermoplastics. Bulletin of Volgograd State University. Series 10, Innovation Activities. [Ol'khov A.A., Iordanskiy A.L., Zaikov G.Ye. (2014). Bioplastiki na osnove termoplastov. Vestnik Volgogradskogo gosudarstvennogo universiteta. Seriya 10, Innovatsionnaya deyatel'nost'] 214. No 3 (12) P. 84-91
- [7] Vasathi K. (2017). Biodegradable Polymers – A Review. Polymer Sciences. V.3. #1:-17.
- [8] Kumai G.S., ed. (1987). Biodegradable Polymers: Prospects and Progress (Series of Special Reports, Report No. 15). Marcel Dekker, Inc., New-York and Basel Publ., 116 p.
- [9] Olkhov A. A., Ivanov V. B., Vlasov S. V., Iordansky A. L. (1998) Climatic testing of composite films based on LDPE and polyhydroxybutyrate (PHB) [Ol'khov A. A., Ivanov V. B., Vlasov S. V., Iordanskiy A. L. (1998). [Klimaticheskoye ispytaniye kompozitsionnykh plenok na osnove PENP i poligidroksibutirata (PGB)] // Plastics. No 6. P. 19-21.
- [10] The truth about bioplastics. (25.12.2017). Source: CityPack-BIO (bio-pack.ru) [Pravda o bioplastikakh.25.12.2017. Istochnik: SitiPak-BIO (bio-pack.ru)]. (In Russ.).
- [11] Bioplastics Market Analysis, Market Size, Application Analysis, Regional Outlook, Competitive Strategies And Forecasts, 2016 to 2024. Market Research Results & Consulting. Grand View Research (2015).
- [12] Part two. All about biodegradable plastics. World Biopolymer Market–2019: <https://ect-center.com/blog/biodegradable-polymers> .
- [13] Berseneva O.A., Kulemina O.A. (2016). Polymers of the new generation // Modern Chemistry: Success and Achievement: Materials of the II Intern. scientific conf. (Chita, April 2016). Chita 2016: 27-29. URL <https://moluch.ru/conf/chem/archive/162/10180/>. [Berseneva O. A., Kulemina O. A. (2016). Polimery novogo pokoleniya // Sovremennaya khimiya: Uspekhi i dostizheniya: materialy II Mezhdunar. nauch. konf. (g. Chita, aprel' 2016 g.). Chita 2016: 27-29. – URL] (In Russ.).
- [14] D. R. Lu, C. M. Xiao, S. J. Xu. (2009) Starch-based completely biodegradable polymer materials. Express Polymer Letters Vol 3, No.6. P. 366-375.
- [15] Buriyak V.P. Biopolymers – the Present and the Future. [Biopolimery – nastoyashcheye i budushcheye]. (In Russ.).
- [16] Overproduction of potatoes awaits Kazakhstan. <https://inbusiness.kz/ru/last/pereproizvodstvo-kartofelya-zhdet-kazahstan>: (In Russ.).
- [17] Wool, R.P. and Sun, X. (2005) Bio-Based Polymer and Composites. Elsevier Academic Press, Cambridge.
- [18] Niranjana Prabhu, T. and Prashantha, K. (2016) A Review on Present Status and Future Challenges of Starch Based Polymer Films and Their Composites in Food Packaging Applications. Polymer Composites. <https://doi.org/10.1002/pc.24236> DOI 10.1002/pc.24236 .
- [19] Sarunya Promkotra, Tawiwani Kangsadan. (2015). Tensile Strength of PHBV/Natural Rubber Latex Mixtures. MATEC Web of Conferences 35, 01001.
- [20] Xiaoying Zhao, Katrina Cornish and Yael Vodovotz. Synergistic Mechanisms Underlie the Peroxide and Coagent Improvement of Natural-Rubber-Toughened Poly(3-hydroxybutyrate-co-3-hydroxyvalerate) Mechanical Performance. Polymers 2019, 11, 565. <http://www.mdpi.com/journal/polymers>. Web of Science
- [21] Uteulin K.R., Bari G.T., Zhaksenbai A. (2020). Dandelion kok-saghyz (Taraxacum kok-saghyz L.Rodin) as a one-year culture developed under conditions of south east Kazakhstan. // Bulletin of National Academy of Sciences of the Republic of Kazakhstan. 3: P.20-28. Web of Science
- [22] Garshin M.V., Kartukha A.I., Kuluyev B.R. (2016). Taraxacum kok-saghyz: cultivation features and perspectives of introduction to modern production / Kok-sagyz: cultivation features, prospects for cultivation and implementation in modern production. [Taraxacum kok-saghyz: osobennosti kul'tivirovaniya, perspektivy vozdeleyvaniya i vnedreniya v sovremennoye proizvodstvo] Biomika. 8. 4: P. 323-333. (In Russ.).

**REPORTS OF THE NATIONAL ACADEMY OF SCIENCES
OF THE REPUBLIC OF KAZAKHSTAN**

ISSN 2224-5227

<https://doi.org/10.32014/2020.2518-1483.118>

Volume 5, Number 333 (2020), 49 – 55

UDC 556.18

Zh.S.Mustafayev, L.N. Ryskulbekova

Kazakh National Agrarian University, Almaty, Republic of Kazakhstan.

E-mail: z-mustafa@rambler.ru; ryskulbekova.laura@mail.ru**FUNDAMENTALS OF WATER USE
IN THE CATCHMENT AREAS OF THE ILI RIVER BASIN**

Abstract. Based on the long-term information and analytical materials «Balkhash-Alakol Basin Inspectorate for Regulation of Use and Protection of Water Resources» of the Committee for Water Resources of the Ministry of Agriculture of the Republic of Kazakhstan, the environmental indicator of specific water availability, which availability high water availability, ensuring sustainable development of economic sectors, but not ensuring the natural and environmental sustainability and safety of functioning of Lake Balkhash, as a geographic water body.

The location in the arid and semi-arid zones, as well as the features of the formation of hydrological flow in the catchment areas of the Ili River basin, which determines the environment-forming system with socio-economic conditions and natural and technogenic objects that determine the level of water supply for water management sites, require the need for coordination of water management in order to prevent possible negative changes in watercourses and reservoirs that perform important environmental functions in the Ili-Balkhash basin, that is, to ensure natural and environmental sustainability and safe functioning of Lake Balkhash as a geographic water body.

Keywords: river, basin, runoff, discharge, catchment, economy, use, water availability, water use, population.

Relevance. In the system of the economy of Kazakhstan, the Ili River basin is a diversified economic complex, which is characterized by environmentally hazardous mining enterprises and non-ferrous metallurgy. On the territory of the basin are also represented mainly engineering enterprises, chemical, food and light industries. Environmentally hazardous enterprises are mainly located in the city of Balkhash (copper production), in Taldykorgan (battery factory), Tekeli (mining industry), Kapchagay (construction materials) and Almaty (engineering and metallurgy).

Peculiarities of water use in the catchment areas of the Ili River basin by various sectors of the economy affect the ecological state of the water system, which requires a comprehensive assessment from the standpoint of water consumption in the economy, as their consumer properties are very important for the region.

Purpose of the study - based on the analysis of the natural and socio-economic conditions in the catchment areas of the Ili River basin, identify the problems and tasks of the development of water management in the region.

Objects of study.

The catchment of the Ili River basin, as a single environment-forming environment, is located on the territory of Kazakhstan and the People's Republic of China. At the same time, 65% of the lake's river flow is formed on the adjacent territory of the Xinjiang Uygur Autonomous Region (XUAR) of the People's Republic of China [1].

The catchment of the Ili River basin originates on the Muzart Glaciers in Central Tanirtau (Kazakhstan), the source of the Tekes River and then flows through the territory of the People's Republic of China (PRC), where it merges with the Kunes and Kas rivers, at the 250th km from the confluence it again enters the Republic Kazakhstan, at 1001 km it flows into Lake Balkhash [1].

The total length of the Ili River is 1439 km, within the Republic of Kazakhstan -815 km. The total area of the Ili river basin is 140 thousand km², that is, approximately 75% of the catchment area of Lake Balkhash, of which 77400 km² are in the territory of the Republic of Kazakhstan. The drainage part of the Ili River basin is located on the territory of the People's Republic of China, where the hydrographic network is quite developed and ranges from 0.60 to 3.00 km / km². Its density decreases in the middle and

lower parts of the catchment area of the Ili River basin, i.e. up to 0.01 km / km², there are vast expanses completely devoid of surface runoff, only the left-bank part of the catchment area of the Ili River basin is active here. About 30% of the water resources of the Ili River are formed on the territory of the Republic of Kazakhstan. In addition to the Sharyn and Shelek rivers, in the left-bank part of the basin in the middle reaches of the Ili River, it also receives a number of mountain rivers: Turgen, Esik, Talgar, Kaskelen with tributaries Malaya and Bolshaya Almaty. In the right-bank part, the largest tributaries of the Ili River are the Korgas, Usek and Borokhudzir rivers flowing down from the southern slopes of Zhetysu Alatau [1].

Materials and research methods. The studies used the long-term information and analytical materials of the «Balkhash-Alakol Basin Inspectorate for Regulation of the Use and Protection of Water Resources» of the Committee on Water Resources of the Ministry of Agriculture of the Republic of Kazakhstan on the volume of water consumption in the economy of the Ili water basin. The catchment area of the Ili river basin is divided into two sections: the upper and lower reaches of the Ili, which are identified on the basis of geomorphological schematization with administrative division in the context of the districts of the Almaty region (table 1).

Table 1 - Ili basin in the context of water plots with administrative divisions

№	Water plot	№	Administrative districts	Area, km ²
I	Upper Ili	14	Enbekshikazakh	8300,0
		17	Talgar	3700,0
		15	Uyghur	8787,0
		8	Kerbulak	11500,0
		9	Panfilov	10600,0
		13	Kapchagai city	3654,03
Total				46541,03
II	Lower Ili	2	Balkhash	37400,0
		11	Ili	7800,0
Total				45200,0
Total				91741,03

Restrictions on water use in the catchment areas of the Ili River basin, associated with the availability of water resources, are determined not only by the natural characteristics of the formation of river flow, but also by the magnitude of the anthropogenic load on the rivers. To determine the level of water availability I.A. Shiklomanov proposed an indicator of specific water availability (thousand m³ / year per person or km³ / year per million people), which determines not only the shortage of water resources, but also allows us to judge the overall state of water resources in the natural conditions of their formation and functioning [2].

The specific water availability indicator (*PB*) in the catchment areas of river basins is determined by the formula [2]:

$$PB = (W_{op} - W_{\sigma\sigma\sigma}) / N,$$

Where W_{op} – real water resources of river basins, km³/year; $W_{\sigma\sigma\sigma}$ - irrevocable water consumption, km³/year; N – population, people.

According to the classification of I.A. Shiklomanova, if the indicator of specific water availability: $PB < 1.0$ – catastrophically low water availability; $PB = -1.10 - 2,00$ – very low water availability; $PB = -2.10 - 5,00$ – low water availability; $PB = -5.10 - 10,00$ – average water availability; $PB = -10.10 - 20,00$ – high water availability; $PB > -$ very high water availability [2].

An analysis of the work to protect and preserve the natural complex of the catchment areas and water bodies shows that the water resources of watercourses and reservoirs cannot be fully used for the needs of economic sectors. A significant part of them must be left in the form of ecological runoff in river systems to preserve ecosystems that ensure the reproduction of valuable aquatic and near-water flora and fauna, i.e., caught meadows, lake systems, and near-water mammals [3, 4, 5, 6]. As a result, there is an urgent need for a quantitative assessment of the water resources reserved in rivers according to environmental criteria, and then the environmental indicator of specific water availability (\mathcal{EPB}) of the catchment areas of river basins is determined by the formula:

$$\mathcal{E}PB = \{[W_{op} \cdot (1 - \alpha_9) - W_{666}]\} / N,$$

where α_9 – coefficient characterizing the ecological runoff in river systems, which is determined on a spatio-temporal scale.

Research results. Based on the long-term information and analytical materials of the Balkhash-Alakol Basin Inspectorate for regulating the use and protection of water resources of the Committee for Water Resources of the Ministry of Agriculture of the Republic of Kazakhstan, covering the years 2002-2017, we analyzed the use of water resources in the sectors of the economy in the catchment areas of the Ili River basin in the context of water management plots and administrative districts of the Almaty region, including housing and communal services, industry and agriculture (table 2).

In the period under review, from 2002 to 2017, the largest volumes of collected water, i.e. 98.0-98.8%, are used for agricultural needs in the catchment areas of the river basin, 0.30-0.70% are used for production purposes and drinking needs 1.30-1.70%. Thus, the main water consumers in the catchment areas of the Ili River basin are agriculture, that is, regular irrigation, where its need is determined by its location in the semi-arid and arid zones, which are characteristic with high energy resources and low natural moisture in the natural system.

Table 2 - Dynamics of water use by administrative regions in the catchments of the Ili River basin, mln. m³

Administrative districts	2002	2003	2004	2005	2006	2007	2008	2009
1	2	3	4	5	6	7	8	9
Housing and communal services (services), mln. m ³								
Upper Ili River catchment								
Enbekshikazakh	3,35	2,66	2,70	2,52	2,73	2,45	4,63	4,81
Talgar	4,53	4,88	4,66	4,92	4,70	4,92	4,59	5,66
Uygur	1,04	0,68	0,00	0,00	0,00	0,00	0,00	0,00
Kerbulak	0,64	0,65	0,32	0,27	0,71	0,79	0,83	0,80
Panfilov	1,75	1,83	1,81	2,56	2,73	2,60	3,16	3,11
Kapchagai city	5,00	5,39	5,42	5,62	7,95	7,61	5,56	6,12
Total	16,31	16,09	14,91	15,89	18,82	18,37	18,77	20,50
Lower Ili River catchment								
Balkhash	0,01	0,96	0,00	0,00	0,00	0,00	0,00	0,00
Ili	2,34	5,20	3,53	4,55	5,04	5,26	5,73	7,12
Total	2,35	6,16	3,53	4,55	5,04	5,26	5,73	7,12
Total	18,66	22,25	18,44	20,44	23,86	23,63	24,50	27,62
Industry, mln. m ³								
Upper Ili River catchment								
Enbekshikazakh	0,62	0,87	0,96	1,92	2,04	2,12	1,30	1,11
Talgar	1,08	0,80	1,42	1,54	1,70	1,43	1,74	1,29
Uygur	0,00	0,00	0,00	0,00	0,00	0,00	0,00	0,00
Kerbulak	0,02	0,02	0,04	0,01	0,01	0,05	0,03	0,06
Panfilov	0,01	0,00	0,02	0,01	0,01	0,01	0,01	0,01
Kapchagai city	8,90	8,92	9,19	7,55	7,81	7,21	7,42	6,21
Total	10,63	10,61	11,63	11,03	11,57	10,82	10,50	8,68
Lower Ili River catchment								
Balkhash	0,00	0,00	0,00	0,00	0,00	0,00	0,00	0,00
Ili	3,90	4,82	5,30	6,23	5,98	4,88	6,55	5,78
Total	3,90	4,82	5,30	6,23	5,98	4,88	6,55	5,78
Total	14,53	15,43	16,96	17,26	17,55	15,70	17,05	14,46
Agriculture, mln. m ³								
Upper Ili River catchment								
Enbekshikazakh	598,8	686,5	816,3	634,4	594,1	514,7	671,0	678,9
Talgar	97,91	86,05	105,5	70,22	97,70	78,50	86,95	121,6
Uygur	148,4	135,1	141,4	134,2	162,3	155,3	133,7	133,9
Kerbulak	109,3	106,1	113,1	119,2	132,9	127,6	133,5	111,7
Panfilov	304,1	317,2	330,5	305,7	322,1	326,7	343,4	366,3
Kapchagai city	25,50	37,95	41,71	43,33	45,38	63,07	66,66	52,80
Total	1284,0	1368,9	1548,5	1307,1	1354,5	1265,9	1435,2	1465,2
Lower Ili River catchment								
Balkhash	628,6	632,3	631,4	631,3	630,1	630,1	630,1	630,1

1	2	3	4	5	6	7	8	9
Ili	29,50	32,19	104,7	68,58	99,3	98,7	108,8	150,1
Total	658,1	644,5	736,1	699,9	729,4	728,8	738,9	780,2
Total	1942,1	2033,4	2284,6	2007,0	2083,9	1994,7	2174,1	2245,4
Administrative districts	Years							
	2010	2011	2012	2013	2014	2015	2016	2017
Housing and communal services (services), mln. m ³								
Upper Ili River catchment								
Enbekshikazakh	4,85	4,45	4,35	5,15	5,42	4,93	4,69	-
Talgar	4,52	5,95	5,49	5,53	5,80	8,26	7,99	-
Uygur	0,00	0,00	0,00	0,00	0,00	0,00	0,00	-
Kerbulak	0,52	0,45	0,45	0,44	0,71	0,65	0,68	-
Panfilov	3,07	2,79	3,20	1,90	3,41	3,92	3,21	-
Kapchagai city	6,76	6,47	6,66	7,00	7,18	6,32	5,86	-
Total	19,72	20,11	20,15	20,02	22,52	24,08	22,43	-
Lower Ili River catchment								
Balkhash	0,00	0,00	0,00	0,00	0,00	0,00	0,41	-
Ili	6,23	5,83	5,67	6,25	5,86	6,24	7,15	-
Total	6,23	5,83	5,67	6,25	5,86	6,24	7,56	-
Total	25,95	25,94	25,82	26,27	28,38	30,32	29,99	-
Industry, mln. m ³								
Upper Ili River catchment								
Enbekshikazakh	0,66	1,15	0,08	1,00	0,84	0,88	1,30	1,31
Talgar	1,41	1,47	1,45	1,63	1,27	1,30	1,60	1,32
Uygur	0,00	0,00	0,00	0,00	0,00	0,00	0,00	0,00
Kerbulak	0,07	0,08	0,06	0,05	0,00	0,03	0,00	0,00
Panfilov	0,01	0,00	0,00	0,00	0,00	0,00	0,00	0,00
Kapchagai city	9,37	7,88	6,07	5,38	6,54	7,38	12,01	9,54
Total	11,52	10,58	7,66	8,06	8,65	9,59	14,91	12,17
Lower Ili River catchment								
Balkhash	0,00	0,00	0,00	0,00	0,00	0,00	0,00	0,00
Ili	5,08	5,38	6,05	7,20	6,35	7,87	8,11	9,10
Total	5,08	5,38	6,05	7,20	6,35	7,87	8,11	9,10
Total	16,60	15,96	13,71	15,26	15,00	17,39	23,02	21,27
Agriculture, mln. m ³								
Upper Ili River catchment								
Enbekshikazakh	560,9	612,4	660,6	622,0	672,1	698,4	695,2	695,1
Talgar	109,5	108,2	110,3	114,8	111,1	108,8	71,4	63,0
Uygur	412,5	152,6	161,1	160,1	161,8	160,2	168,3	147,5
Kerbulak	99,2	108,6	94,7	121,1	122,5	142,3	125,5	114,4
Panfilov	315,5	371,7	351,6	381,1	435,4	490,7	478,7	492,3
Kapchagai city	55,91	64,79	63,64	60,77	66,20	55,86	42,49	53,00
Total	1553,5	1418,3	1441,9	1521,0	1569,1	1656,3	1581,6	1565,3
Lower Ili River catchment								
Balkhash	503,6	500,1	500,1	503,5	504,1	504,1	503,6	503,6
Ili	101,5	103,1	98,3	99,9	88,0	100,0	74,5	77,9
Total	605,1	603,2	598,4	603,4	592,1	604,1	578,1	581,5
Total	2158,6	2021,5	2883,8	2124,4	2161,2	2260,4	2159,7	2146,8

In the directly catchment areas of the Ili River basin, there are 7 administrative districts, i.e. Enbekshikazakh, Talgar, Uygur, Kerbulak, Panfilov, Balkhash and Ili districts of the Almaty region and the city of Kapchagai, where the population over the years from 2002 to 2017 increased from 809252 up to 1048566 people, which must be taken into account when assessing water availability in the context of water management plots (table 3).

Table 3 - Population dynamics by administrative regions in the catchments of the Ili River basin, people

Administrative districts	Years							
	2002	2003	2004	2005	2006	2007	2008	2009
Upper Ili River catchment								
Enbekshikazakh	203964	204142	204517	204703	204845	207041	211510	215528
Talgar	133975	135555	137836	140590	143579	146673	150699	153880
Uyгур	63810	63904	63904	63867	63778	63668	63765	64504
Kerbulak	92516	91917	91400	90538	90259	90466	91028	91690
Panfilov	114717	115128	115594	116233	116810	117652	118497	119509
Kapchagai city	45078	45994	47606	50080	50703	51667	53082	54449
Total	654060	658201	660857	666011	669974	674516	688581	693760
Lower Ili River catchment								
Balkhash	30832	30740	60501	30231	30166	30179	30082	30043
Ili	124360	126654	130543	133938	136984	141289	145485	149125
Total	155192	157394	191044	164169	171664	171468	175567	179168
Total	809252	815595	851901	830180	841638	716635	864148	820728
Administrative districts	Years							
	2010	2011	2012	2013	2014	2015	2016	2017
Upper Ili River catchment								
Enbekshikazakh	261283	266616	272637	278552	283556	288022	291950	294446
Talgar	173923	177650	181439	184845	189359	183908	186552	187668
Uyгур	61293	61754	61871	62319	62710	63280	63374	63419
Kerbulak	87053	88178	88720	89243	89768	90446	91053	91072
Panfilov	114375	116178	117530	119938	122136	124695	125886	126992
Kapchagai city	53646	54956	56033	56868	57525	59052	60230	60892
Total	751573	765332	778230	791765	805054	809403	819045	824489
Lower Ili River catchment								
Balkhash	30101	30319	30259	30404	30764	31134	31290	31367
Ili	176020	181740	187915	191890	196961	188900	190429	192710
Total	179030	212059	218174	222294	227725	220034	221719	224077
Total	930603	977391	996404	1014059	1032779	1029437	1040764	1048566

Table 4 - Ecological indicators of the specific water supply of the Ili water basin

Years	Ili water basin					
	Upper Ili River catchment			Lower Ili River catchment		
	Real water resources (W_{op} , km ³)	Irrevocable water consumption ($W_{\text{обс}}$, km ³)	Specific water availability indicators (ЭПБ)	Real water resources (W_{op} , км ³)	Irrevocable water consumption ($W_{\text{обс}}$, км ³)	Specific water availability indicators (ЭПБ)
2002	17,740	1,311	15,627	21,200	0,664	84,619
2003	16,090	1,396	13,773	18,760	0,655	73,497
2004	13,460	1,575	10,535	17,337	0,745	55,099
2005	13,220	1,334	10,899	15,043	0,704	55,328
2006	13,950	1,385	14,096	15,839	0,743	55,861
2007	13,610	1,295	10,976	14,504	0,739	50,811
2008	9,690	1,464	6,941	13,376	0,751	45,390
2009	12,040	1,494	9,878	12,494	0,787	40,972
2010	18,870	1,585	14,221	22,677	0,616	78,905
2011	14,730	1,446	10,625	18,748	0,614	54,585
2012	10,920	1,470	7,234	13,058	0,610	36,136
2013	10,160	1,549	6,383	13,182	0,617	35,817
2014	8,132	1,600	4,579	11,064	0,604	29,541
2015	12,546	1,670	8,016	11,413	0,618	30,911
2016	19,026	1,619	13,123	21,266	0,594	59,057
2017	14,819			18,114		

To determine the coefficients characteristic of environmental resources, methodological approaches are used to assess the maximum permissible use of water resources and the environment. Zh. S. Mustafayev and K. Zh. Mustafayev [3], where data on quantitative values within 0.35 are given that

are used to determine the environmental indicators of specific water supply in the catchment areas. Ili River.

Based on the data presented in tables 2 and 3 characterizing the level of water use in the sectors of the economy and the population spanning 2002-2017, environmental indicators of specific water availability in the catchment areas of the Ili River basin for water management sites were determined (table 4), which showed that in the upper catchment area of the Ili River, they range from 4.579 to 15.627, which correspond to values from low water availability to high water supply depending on the water content of the river, and in the lower catchment area of the Ili River, their quantitative values range from 29.541 to 84.619, which indicate a very high water supply.

It should be noted that very high water availability in the lower catchment area of the Ili River basin, provided, on the one hand, by the presence of a hydroelectric power station in the Kapshagai reservoir, which ensures guaranteed runoff and, on the other hand, a very low population due to adverse climatic conditions adversely affecting human living conditions.

Conclusions. The location in the arid and semi-arid zones, as well as the features of the formation of hydrological flow in the catchment areas of the Ili River basin, which determines the environment-forming system with socio-economic conditions and natural and technogenic objects that determine the level of water supply for water management sites, require the need for coordination of water management in order to prevent possible negative changes in watercourses and reservoirs that perform important environmental functions in the Ili-Balkhash basin, that is, to ensure natural and environmental sustainability and safe functioning of Lake Balkhash as a geographic water body.

Ж.С. Мұстафаев, Л.М. Рысқұлбекова

Қазақ ұлттық аграрлық университеті, Алматы, Қазақстан

ІЛЕ ӨЗЕНІНІҢ СУ ЖИНАУ АЛАБЫ АЙМАҒЫНДАҒЫ СУ РЕСУРСЫН ПАЙДАЛАНУ ЕРЕКШЕЛІКТЕРІ

Аннотация. Қазақстан Республикасы Ауылшаруашылық министрлігіне қарасты Су ресурстары комитетінің «Балқаш-Алакөл алабының суды реттеп пайдалану және қорғау инспекциясы» мекемесінің 2002-2017 жылдар аралығын қамтитын көпжылдық ақпараттық-талдау мәліметтері негізінде Іле өзенінің су жинау алабының су шаруашылық бөлімшелері аймағына орналасқан Алматы облысының әкімшілік аудандары деңгейіндегі суды пайдаланудың аймақтық ерекшеліктерін анықтау үшін экономика саласының тұрмыстық және өндірістік қызметіне, ауылшаруашылығына пайдаланылған су ресурстарына талдау жасалған.

Су жинау алабы және су нысандарының табиғи кешенін қорғау және сақтау жөніндегі жұмыстарды талдау көрсеткендей, су ағынын және су айдынындағы су ресурстарын экономика саласының қажеттіліктері үшін толығымен пайдалануға болмайтынын көрсетеді. Олардың едәуір бөлігі құнды су және жартылай сулы флора мен фаунаның, яғни шабындық, көл жүйесінің және жартылай сулы сүтқоректілерді көбейтуді қамтамасыз ететін экожүйені сақтау үшін өзен жүйесінде экологиялық ағын түрінде қалдырылуы тиіс.

Қарастырылып отырған кезеңде, 2002 жылдан бастап 2017 жылға дейін өзен су жинау алабы аймағындағы су ресурстарының көп мөлшері, яғни 98,0-98,8% ауылшаруашылық қажеттілігіне, 0,30-0,70% өндірістік және шаруашылық мақсаттарға жұмсалады, ал 1.30-1.70% тұрмыстық қызметке пайдаланылған. Сонымен, Іле өзені су жинау алабы аймағындағы судың негізгі тұтынушысы ауыл шаруашылығы, яғни тұрақты суармалы егістік жүйесі, мұнда оның қажеттілігі аймақтың жоғары энергетикалық ресурстармен және табиғи жүйенің табиғи ылғалдылығымен сипатталатын жартылай құрғақ және құрғақ аймақта орналасуы негізінде анықталады.

Экономика салаларындағы суды пайдалану деңгейін және жергілікті тұрғындар санын сипаттайтын 2002-2017 жылдар аралығындағы көпжылдық мәліметтер негізінде Іле өзені сужинау алабының сушаруашылық бөлімшелерінде судың нақты қолжетімділігінің экологиялық көрсеткіштері анықталды, бұл Іле өзенінің жоғарғы ағысында 4,579-дан 15,627-ге дейін өзгеретінін көрсетеді, ал ол сумен қамтамасыз етудің төменгі деңгейімен жоғарғы деңгейде қамтамасыз етуге дейінгі мәнге сәйкес келеді және Іле өзенінің төменгі ағысында олардың сандық мәні 29,541-ден 84,619-ға дейін өзгереді, бұл аймақтың өте жоғары дәрежеде сумен қамтамасыз етілетінін көрсетеді.

Түйін сөздер: өзен, алап, ағын, су жинау, экономика, пайдалану, сумен қамтамасыз ету, суды пайдалану, тұрғындар.

Ж. С. Мустафаев, Л.М. Рыскулбекова

Казахский национальный аграрный университет, Алматы, Казахстан

ОСНОВЕННОСТИ ВОДОПОЛЬЗОВАНИЯ НА ТЕРРИТОРИЯХ ВОДОСБОРОВ БАСЕЙНА РЕКИ ИЛИ

Аннотация. На основе многолетних информационно-аналитических материалов Балхаш-Алакольской бассейновой инспекции по регулированию использования и охране водных ресурсов Комитета по водным ресурсам Министерства сельского хозяйства Республики Казахстан, охватывающих 2002-2017 годы, проведен анализ использования водных ресурсов в отраслях экономики на территориях водосбора бассейна реки Или в разрезе водохозяйственных участков и административных районов Алматинской области, включающих жилищно-коммунальное хозяйство, промышленность и сельское хозяйство для выявления региональной особенности водопользования.

Анализ работы по охране и сохранению природного комплекса водосборных территорий и водных объектов показывает, что водные ресурсы водотоков и водоемов нельзя целиком использовать на нужды отраслей экономики. Значительную часть их необходимо оставлять в виде экологического стока в речных системах для сохранения экосистем, обеспечивающих воспроизводство ценной водной и околородной флоры и фауны, то есть пойманных лугов, озерных систем и околородных млекопитающих.

В рассматриваемый период, с 2002 по 2017 г. – на территориях водосбора бассейна реки наибольшие объемы забранной воды, то есть 98,0-98,8 % используются на сельскохозяйственные нужды, в производственных целях потребляется 0,30-0,70 % и на хозяйственно-питьевые нужды – 1,30-1,70 %. Таким образом, основными водопотребителями в водосборных территориях бассейна реки Или является сельское хозяйство, то есть регулярное орошение, где необходимость его определяется расположением в полуаридной и аридной зонах, характерных с высокими энергетическими ресурсами и низкой естественной увлажненностью природной системы.

На основе данных, характеризующих уровень водопользования в отраслях экономики и численность населения, охватывающих 2002-2017 годы, определены экологические показатели удельной водообеспеченности в водосборных территориях бассейна реки Или по водохозяйственным участкам, которые показали, что верховьях водосбора реки Или, они колеблется от 4,579 до 15,627, что соответствуют значениям от низкой водообеспеченности до высокой водообеспеченности в зависимости от водности реки, а в низовьях водосбора реки Или, их количественные значения колеблется от 29,541 до 84,619, что показывают очень высокую водообеспеченность.

Ключевые слова: река, бассейн, сток, водосбор, экономика, использование, водообеспеченность, водопользование, население.

Information about authors:

Mustafayev Zhumakhan Suleimenovich, Doctor of Technical Sciences, Professor, Professor of the Department «Water Resources and Melioration», Kazakh National Agrarian University; z-mustafa@rambler.ru; <https://orcid.org/0000-0003-24258148>;

Ryskulbekova Laura Meldakhanovna, Document PhD of the Department «Water Resources and Land Reclamation», Kazakh National Agrarian University; ryskulbekova.laura@mail.ru; <https://orcid.org/0000-0002-1374-5920>

REFERENCES

- [1] Burlibaev M.Zh., Amirgaliev N.A., Shenberger I.V., Sokalsky V.A., Burlibaeva D.M., Uvarov D.V., Simernova D.A., Efimonko A.V., Milyukov D.Yu. Problems of pollution of the main transboundary rivers of Kazakhstan. Almaty: Kanagat, 2014. Volume 1. 742 p.
- [2] Water resources of Russia and their use (edited by I. A. Shiklomanov). SPb: State Hydrological Institute, 2008. 600 p.
- [3] Mustafaev Zh.S., Mustafaev K.Zh. Meteorological basis for assessing the maximum permissible use of natural resources (analytical review). Taraz, 2011. 45 p.
- [4] Burlibaev M.Zh., Fashchevsky B.V., Opp K., Burlibaeva D.M., Kaydarova R.K., Vagapova A.R. Scientific basis for the regulation of the ecological flow of rivers in Kazakhstan. Almaty: Kanagat Publishing House, 2014. 408 p.
- [5] Mustafaev K.Zh. Meteorological foundations of environmental assessment of the capacity of natural systems. Taraz: «Format-Print», 2014. 316 p.
- [6] Mustafayev K.Zh., Maimekov Z.K. Environmental services in river basins. Taraz: «Format-Print», 2015. 146 p.

**D. Volkov, A. Argynbayeva, D. Daurov, K. Zhapar,
Zh. Abai, K. Zhambakin, M. Shamekova**

Institute of plant biology and biotechnology, Almaty, Kazakhstan.

E-mail: m.shamekova@gmail.com, volkovdmitriy kz@gmail.com, asselargynbayeva@gmail.com,
dias.daurov@gmail.ru, zhapar.zk@gmail.com, abaizh097@mail.ru, zhambakin@gmail.ru,
m.shamekova@gmail.com

ACCELERATED PRODUCTION OF VIRUS-FREE POTATO PLANTING MATERIAL USING A BIOREACTOR

Abstract. Potato production is one of the key branches of crop production that determines the food security of Kazakhstan. The Republic needs over 800,000 tons of seed potatoes per year. In addition to seed potatoes, which are grown in Kazakhstan, about 30,000 tons of seed potatoes are imported annually, while about 80% of this volume is imported from the Netherlands through private companies [1].

In 2018, 193.0 thousand hectares were occupied under potatoes in Kazakhstan, while the gross harvest amounted to 3806.9 thousand tons. At the same time, the yield in 2018 was only 19.8 t/ha. While in neighboring Uzbekistan in 2018, the yield was 33.68 t/ha, the maximum yield in New Zealand in 2018 was about 50.41 t/ha [2]. It is known that one of the main reasons for low potato yield is low-quality seed material.

In Kazakhstan, mainly after obtaining virus-free plants *in vitro* through meristem culture, minitubers are obtained from them in most technological processes; in rare cases, microtubers are obtained from meristem plants *in vitro* and then minitubers from them.

Research has shown that the bioreactor can massively clone meristem plants and get full-fledged virus-free microtubules reducing a significant proportion of manual labor, thereby reducing the impact on the result of the human factor, reduce infections, and reduce labor costs and material costs.

Key words: potato, microtubers, minitubers, virus-free culture, DAS-ELISA.

Introduction. The main requirement for quality seed material is the absence of pathogenic and quarantine diseases. There are about 40 types of viruses and 2 viroids that affect potatoes [3]. Depending on the defeat of viral diseases, the yield drops to 90% on production crops [4].

Healthy and high-quality potato seeds are the basis of potato seed production [5]. First of all the seed material must be free of pathogenic microorganisms.

After obtaining virus-free plants *in vitro* through meristem culture, in most technological processes, minitubers are obtained from them. The production of mini-tubers is the final stage of obtaining virus-free material [6].

Recently, the production of microtubers is often used from which, as from meristem plants *in vitro*, minitubers are obtained.

Microtubers are the result of *in vitro* cultivation of plants in an artificial nutrient medium [7]. Many studies are aimed at improving the efficiency of obtaining microtubers and increasing their size, for example, by cyclically immersing plants in a liquid nutrient medium during tuber formation [8]. At the same time, despite a sufficient number of publications on the production of microtubers *in vitro*, there is still little information on their testing in the ground [9]. In global seed production, minitubers are currently an intermediate between the production of meristem plants and microtubers *in vitro* and field propagation of seed material. The production of seed potatoes using minitubers requires much stricter control of the resistance of the planting material to abiotic and biotic stress factors [10]. When planting mini-tubers

directly in the field, their size is of great importance [11] and Rykaczewska [12] found that the larger the microtubers, the more uniform the seedlings, the higher the yield and the dry mass content.

Methods. Isolating the apical meristem. Excised shoot tips collected from actively growing twigs wash under running tap water and disinfect with 0.1% mercuric chloride solution containing approximately 0.02% Tween-20 for 6 min inside a running laminar air flow cabinet. Treated explants wash four to five times with sterile distilled water to remove the effect of the sterilizing agent. Shoot apical meristem consisting of the apical dome with one to two leaf primordia isolates using sterile hypodermic needle and scalpel under a dissecting microscope. To avoid dehydration isolated meristems (0.3–0.5 mm) transfer quickly on the filter paper bridge in test tubes containing sterilized liquid MS medium with the addition of kinetin 2 mg / l and 0.5 mg/ l gibberellic acid. After 4 weeks, the developed meristems subculture on semisolid medium with the addition of kinetin 3 mg/l and gibberellic acid 0.5 mg/l for further growth for shoot elongation and root formation [13,14,15]. After 2-3 weeks received plantlets transplanted into semisolid MS medium without hormones supplemented with vitamins, 3% sucrose, 0.8% agar, pH 5,7. After 4 weeks of culture on MS medium without hormones plantlets were cloned for further propagation and testing.

The cultivation in bioreactor

A hundred single explants are transferred to a bioreactor with 1000 ml of liquid medium with 30 g/l of sucrose and cultivated for 4 weeks with constant illumination about 2.5 W/m². Explants are grown to 15 cm. Then the medium is changed to 8000 ml of a liquid medium with 90 g/l of sucrose and cultivated for 6 weeks with constant illumination about 0,9 W/m² at 25 °C. The medium enters the bioreactor every 6 hours and is present for 1 hour, so explants absorb the liquid medium only 1 hour every 6 hours. The bioreactor is aerated with sterile air from the calculation of 1 ml/min of air per 10 ml of liquid medium [16].

Total DNA extraction

Extraction of DNA from the plants is performed using the manufacturer's instructions commercial for nucleic acid extraction kits or CTAB method [17].

Total RNA extraction

Extraction of RNA from the plants is performed using the manufacturer's instructions commercial for nucleic acid extraction kits [18].

Reverse transcription reaction isolated RNA

The reaction of reverse transcription extracted RNA is performed using the instructions attached to Sileks reagents [19].

Double Antibody Sandwich ELISA (DAS-ELISA) will be done using commercial kits according to the manufacturer's instructions [20].

Results and discussions. After isolation of the apical meristem of potatoes during 30 days of cultivation, meristem plants of five varieties (Minerva, Romano, Aladin, Soprano from the Netherlands) and (Nevsky from Russia) were obtained, which were checked for the absence of PVM, PVS, PVX, PVY viruses by PCR and ELISA analysis (table 1).

Thus, plants that were pure for all four viruses were selected, which were cloned *in vitro* and used to produce microtubers in a bioreactor. Healthy plants were divided into nodal segments and placed in a bioreactor (10 nodal segments of each variety in three repetitions) with a liquid nutrient medium optimized by MS with sucrose 30 g/l, kinetin 2 mg/l and gibberilinic acid 0.5 mg/l where they were cultivated for 30 days at a temperature of 25°C, light mode 16/8 day/night.

Then the plants obtained from the nodal segments were cultivated in a bioreactor with a liquid nutrient medium MS with sucrose 90 g/l and kinetin 2 mg/l at 18°C, light mode 0/24 day/night for 60 days before harvesting microtubers.

The formation of microtubers in different varieties began in about 15-20 days, the harvest was collected on day 60.

Table 1 – Testing of meristem plants for the presence of viruses for further cultivation in a bioreactor.

Variety	Virus	RT-PCR Multiplex		IFA	
		Quantity of positive samples, PCs	% relation	Quantity of positive samples, PCs	% relation
Minerva	PVM	0	0	0	0
	PVS	0	0	0	0
	PVX	0	0	0	0
	PVY	2	25	1	12.5
Romano	PVM	0	0	0	0
	PVS	0	0	0	0
	PVX	0	0	0	0
	PVY	0	0	0	0
Aladin	PVM	7	28	7	28
	PVS	3	12	0	0
	PVX	1	4	1	4
	PVY	3	12	2	8
	PVM/PVS	1	4	0	0
	PVM/PVY	1	4	1	4
	PVM/PVS/PVY	1	4	0	0
	PVM/PVX/PVY	1	4	1	4
Soprano	PVM	19	61.29	15	48.38
	PVS	10	32.2	2	6.45
	PVX	0	0	0	0
	PVY	0	0	0	0
	PVM/PVS	10	32.2	2	6.45

Table 2 – The formation of potato microtubers in the bioreactor

Variety	The beginning of the formation of microtubers	Quantity (PCs/plant)	Weight of microtuber (g)
Minerva	18	0,7(±0,48)	0,169(±0,017)
Romano	19	0,8(±0,63)	0,143(±0,014)
Aladin	21	0,5(± 0,53)	0,65(±0,007)
Soprano	15	1(±0,67)	0,310 (±0,021)
Nevsky	17	1,2(±0,63)	0,156(±0,008)

Depending on the genotype, the difference in the beginning of microtuber formation in the bioreactor after placing plants in the dark phase was 6 days, the largest microtubers were in the Aladin variety – 0.65 (±0.007) g, then in Minerva 0.310 (±0.021) g and less than 0.2 g in Romano, Aladin and Nevsky.

Microtubers obtained in the bioreactor were analyzed for the presence of PVM, PVS, PVX, and PVY. As a result, 2 samples of the Aladdin variety infected with PVM were detected in one of three replications (table 3). The microtubers were selected one from each of the plants.

Table 3 - Checking microtubers obtained in the bioreactor for the presence of viruses

№ of samples	Viruses							
	PVM		PVS		PVX		PVY	
	PCR	IFA	PCR	IFA	PCR	IFA	PCR	IFA
1	2	3	4	5	6	7	8	9
Minerva								
1	-	-	-	-	-	-	-	-
2	-	-	-	-	-	-	-	-
3	-	-	-	-	-	-	-	-
4	-	-	-	-	-	-	-	-
5	-	-	-	-	-	-	-	-
6	-	-	-	-	-	-	-	-
7	-	-	-	-	-	-	-	-
8	-	-	-	-	-	-	-	-
9	-	-	-	-	-	-	-	-
10	-	-	-	-	-	-	-	-

<i>table continuation 3</i>								
1	2	3	4	5	6	7	8	9
Aladin								
1	-	-	-	-	-	-	-	-
2	-	-	-	-	-	-	-	-
3	-	-	-	-	-	-	-	-
4	-	-	-	-	-	-	-	-
5	+	-	-	-	-	-	-	-
6	-	-	-	-	-	-	-	-
7	-	-	-	-	-	-	-	-
8	-	-	-	-	-	-	-	-
9	+	-	-	-	-	-	-	-
10	-	-	-	-	-	-	-	-
Romano								
1	-	-	-	-	-	-	-	-
2	-	-	-	-	-	-	-	-
3	-	-	-	-	-	-	-	-
4	-	-	-	-	-	-	-	-
5	-	-	-	-	-	-	-	-
6	-	-	-	-	-	-	-	-
7	-	-	-	-	-	-	-	-
8	-	-	-	-	-	-	-	-
9	-	-	-	-	-	-	-	-
10	-	-	-	-	-	-	-	-
Soprano								
1	-	-	-	-	-	-	-	-
2	-	-	-	-	-	-	-	-
3	-	-	-	-	-	-	-	-
4	-	-	-	-	-	-	-	-
5	-	-	-	-	-	-	-	-
6	-	-	-	-	-	-	-	-
7	-	-	-	-	-	-	-	-
8	-	-	-	-	-	-	-	-
9	-	-	-	-	-	-	-	-
10	-	-	-	-	-	-	-	-
Nevsky								
1	-	-	-	-	-	-	-	-
2	-	-	-	-	-	-	-	-
3	-	-	-	-	-	-	-	-
4	-	-	-	-	-	-	-	-
5	-	-	-	-	-	-	-	-
6	-	-	-	-	-	-	-	-
7	-	-	-	-	-	-	-	-
8	-	-	-	-	-	-	-	-
9	-	-	-	-	-	-	-	-
10	-	-	-	-	-	-	-	-

Analysis for the presence of viruses in microtubers showed that control is necessary at this stage, since microtubers are piece material and getting infected material into the further process will allow mass replication of viruses in the seed material.

The virus-free microtubers obtained in the bioreactor were stored and stratified for 6 months in dark conditions at a temperature of 4°C. Then the microtubers were placed in the light at a temperature of 20 to 25°C for 30 days until the shoots appeared and transplanted into pots in controlled conditions of the greenhouse for 15 days until the plants reached the phase 5 leaves and then transplanted into the open ground for 30 pieces of each variety. Harvesting of microtubers was carried out 3 months after planting seedlings in the open ground.

According to the results of morphological analysis of microtubers (figure 1, table 4), they were smooth without flaws and standard for further seed production and the maximum number of them was in Soprano and Nevsky varieties, the average in Minerva and Romano, and the minimum in Aladin.

Table 4 – Morphological parameters of minitubers

№	Name of the variety	Quantity of minitubers from plants, PCs	Weight of the tuber, g
1	Soprano	8,1(±2,4)	24(±16,3)
2	Nevsky	9(±3,9)	12,9(±5,6)
3	Aladin	3,6(±1,4)	5,84(±4,9)
4	Minerva	5,5(±1,9)	13,1(±3,4)
5	Romano	6(±2,9)	11,2(±10)

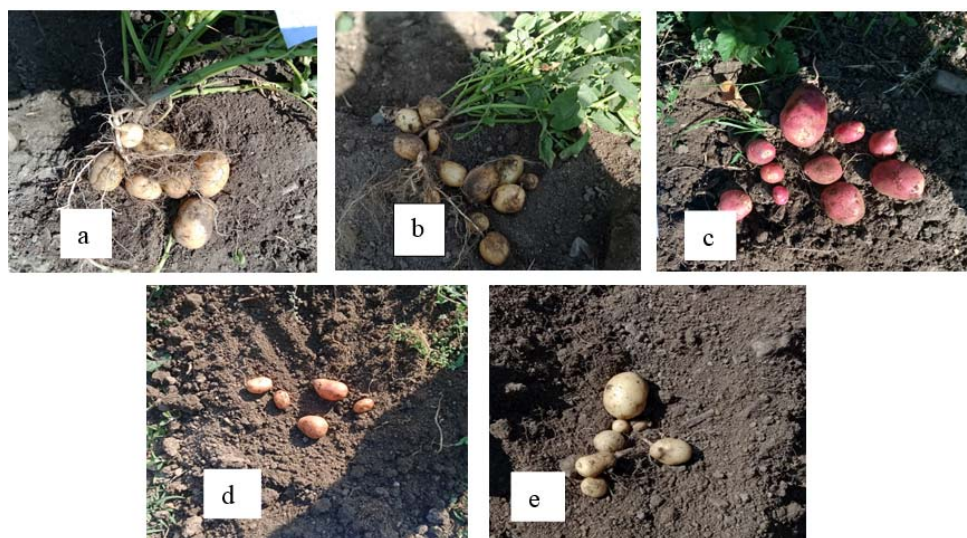

Figure 2 – Minitubers of varieties: a - Soprano, b - Nevsky, c - Aladin, d - Minerva, e - Romano

From the conducted research, it can be concluded that with the help of a bioreactor, it is possible to obtain high-quality microtubers from which high-quality virus-free minitubers will be obtained. The process can be accelerated by earlier collection of microtubers from the bioreactor, for example, after 45 days, since all 5 varieties had normally formed microtubers at 45 days. In addition, studies have shown that the bioreactor can massively clone meristem plants and get full-fledged virus-free microtubers, reducing a significant proportion of manual labor, thereby reducing the impact on the result of the human factor, reducing infections, reducing labor costs and material costs.

Acknowledgments. The study was part of the project AP05131947: “Highly efficient production of potato virus-free planting material using a bioreactor”, funded by a grant from the Science Committee of the Ministry of Education and Science of the Republic of Kazakhstan.

Д.В. Волков, Ә.М. Арғынбаева, Д. Л. Дауров,
Қ.Қ. Жапар, Ж.С. Абай, Қ.Ж. Жамбакин, М.Х. Шамекова

Өсімдіктер биологиясы және биотехнологиясы институты, Алматы, Қазақстан

БИОРЕАКТОРДЫҢ КӨМЕГІМЕН КАРТОПТЫҢ ВИРУССЫЗ ОТЫРҒЫЗУ МАТЕРИАЛЫН ЖЕДЕЛДЕТІП ӨНДІРУ

Аннотация. Картоп өсіру шаруашылығы – Қазақстандағы азық-түлік қауіпсіздігін анықтайтын өсімдік шаруашылығының негізгі салаларының бірі. Республикаға жылына 800000 тоннаға дейін тұқымдық картоп қажет. Қазақстанда өсірілетін тұқымдық картоптан басқа, жыл сайын 30 мың тоннаға жуық тұқымдық картоп импортталады, оның 80% Нидерландыдан жеке компаниялар арқылы әкелінеді.

Қазақстанда 2018 жылы картоп 193,0 мың гектарды қамтыса да, жалпы өнім 3806,9 мың тонна болды. Сонымен бірге, 2018 жылы жалпы өнім 19,8 ц / га жетті. 2018 жылы көршілес Өзбекстанда өнімділік 33,68 т/га

болса, Жаңа Зеландияда жоғары өнімділік 2018 жылы шамамен 50,41 т/га құраған. Картоп өнімінің азаюының басты себебіне сапасыз тұқым материалы жататыны белгілі. Соңғы кезде *in vitro* меристемалы өсімдігінен шағын түйнектер алынды, соның ішінде микро-түйнек өндірісі қолданылады. Микро-түйнектер жасанды қоректік ортада *invitro* өсімдіктерін өсіргенде пайда болады.

Шағын түйнек – *in vitro* меристемалы өсімдіктен немесе микро-түйнектен алынатын кішкентай түйнек. Отырғызғанда әртүрлілігі мен тығыздығына байланысты мөлшері 10-нан 50 мм-ге дейін өзгереді. Шағын түйнектің тұқымдық құндылығы қоздырғыштардың болмағандығымен және мөлшері арқылы анықталады. Бір *in vitro* меристемалы өсімдіктен немесе жабық жердегі микро-түйнектен 2-ден 10-ға дейін шағын түйнек, ал егер гидропоника қолданғанда -40-қа дейін шағын түйнек алуға болады. Әлемдік өндірісте шағын түйнек қазіргі уақытта меристемалы өсімдік, *in vitro* микро-түйнегін алу мен тұқымдық материалдың дала әдісімен көбеюі арасындағы аралық байланыс болып саналады. Шағын түйнек арқылы тұқымдық картопты өндіру отырғызу материалының абиотикалық және биотикалық стресс факторына төзімдігін қатаң қадағалауды қажет етеді. Шағын түйнекті далаға тікелей отырғызғанда мөлшерінде ерекшелік пайда болады. Rykaczewska түйнегі неғұрлым көп болса, соғұрлым біркелкі көшет, кіріс пен құрғақ массаның мөлшерінің жоғары екені анықталды.

Қазақстанда, негізінен, меристемалық дақыл арқылы *in vitro* вирусыз өсімдіктер алғаннан кейін, көптеген технологиялық процестер арқылы минут-түйнекше, сирек жағдайда меристемалық өсімдіктен микро-түйнекше алынады, содан кейін одан минут-түйнекше алуға мүмкіндік туады.

Зерттеулер көрсеткендей, биореактордағы меристемалық өсімдіктерді жаппай клондау жұмысы қол еңбегінің үлесін едәуір азайтады, осылайша адами фактордың зерттеу нәтижесіне әсерін, ластануды, еңбек және материалдық шығынды азайту арқылы толыққанды вирусыз микро-түйнекше алуға болады.

Түйін сөздер: картоп, минут-түйнек, вирусыз культура, ПЦР, DAS-ELISA.

**Д.В. Волков, А.М. Аргынбаева, Д. Л. Дауров,
К.К. Жапар, Ж.С. Абай, К.Ж. Жамбакин, М.Х. Шамекова**

Институт биологии и биотехнологии растений, Алматы, Казахстан

УСКОРЕННОЕ ПРОИЗВОДСТВО БЕЗВИРУСНОГО ПОСАДОЧНОГО МАТЕРИАЛА КАРТОФЕЛЯ С ПОМОЩЬЮ БИОРЕАКТОРА

Аннотация. Картофелеводство является одной из ключевых отраслей растениеводства, определяющих продовольственную безопасность Казахстана. Республике требуется до 800 000 тонн семенного картофеля в год. Помимо семенного картофеля, который выращивается в Казахстане, ежегодно импортируется около 30 000 тонн семенного картофеля, при этом около 80% из этого объема ввозится из Нидерландов через частные компании.

Под картофелем в Казахстане 2018 году было занято 192,3 тыс. га при этом, валовый сбор составил 3806,9 тыс. тонн. При этом урожайность в 2018 году составила только 19,8 т/га. В то время как в соседнем Узбекистане в 2018 году урожайность составила 33,68 т/га, максимальная урожайность в Новой Зеландии в 2018 году была около 50,41 т/га. Известно, что одной из основных причин низкой урожайности картофеля является некачественный семенной материал.

В последнее время часто используется производство микро-клубней, из которых как из меристемных растений *in vitro* получают миниклубни. Микро-клубни являются результатом культивирования растений *in vitro* в искусственной питательной среде.

Миниклубни представляют собой небольшие клубни, полученные из меристемных растений *in vitro* или из микро-клубней. В зависимости от сорта и плотности посадки их размер колеблется от 10 до 50 мм. Семенная ценность миниклубней определяется отсутствием патогенов и размером. Из одного меристемного растения *in vitro* или микро-клубня в закрытом грунте можно получить от 2 до 10 миниклубней, если использовать гидроponику - до 40 миниклубней. В мировом производстве миниклубни в настоящее время представляют собой промежуточное звено между получением меристемных растений и микро-клубней *in vitro* и полевым размножением семенного материала. Производство семенного картофеля с помощью миниклубней требует гораздо более строгого контроля устойчивости посадочного материала к абиотическим и биотическим стрессовым факторам. При высадке миниклубней непосредственно в полевые условия, большое значение имеет их размер. Rykaczewska обнаружила, что чем больше миниклубни, тем более равномерные всходы, выше урожай и содержание сухой массы.

Производство миниклубней является финальной стадией получения безвирусного семенного материала. В Казахстане в основном после получения безвирусных растений *in vitro* через культуру меристем в большинстве технологических процессах из них получают миниклубни, в редких случаях из меристемных растений получают микро-клубни *in vitro* и затем из них миниклубни.

Исследования показали, что в биореакторе можно массово клонировать меристемные растения и получать полноценные безвирусные микроклубни сократив значительную долю ручного труда, тем самым снизить влияние на результат человеческого фактора, сократить заражения, сократить расходы на оплату труда и расходы на материалы.

Ключевые слова: картофель, миниклубни, безвирусная культура, ПЦР, DAS-ELISA.

Information about authors:

Dmitriy Vladimirovich Volkov: Institute of plant biology and biotechnology. Timiryazeva 45, Almaty, Kazakhstan. Senior researcher at the laboratory of breeding and biotechnology, master of biology; volkovdmitriy.kz@gmail.com; <https://orcid.org/0000-0003-4609-7912>;

Assel Mukhtarkyzy Argynbayeva: Institute of plant biology and biotechnology. Timiryazeva 45, Almaty, Kazakhstan. Junior researcher at the laboratory of breeding and biotechnology, master of biotechnology; asselargynbayeva@gmail.com; <https://orcid.org/0000-0002-2436-6926>;

Dias Lamzarovich Daurov: Institute of plant biology and biotechnology. Timiryazeva 45, Almaty, Kazakhstan. Research associate of the laboratory of breeding and biotechnology, master of biotechnology; dias.daurov@gmail.ru; <https://orcid.org/0000-0003-3073-4577>;

Kuanys Kabylyuly Zhapar: Institute of plant biology and biotechnology. Timiryazeva 45, Almaty, Kazakhstan. Junior researcher at the laboratory of breeding and biotechnology, master of biology; zhapar.zk@gmail.com; <https://orcid.org/0000-0002-9007-9730>;

Zhandos Sailaubekuly Abai: Institute of plant biology and biotechnology. Timiryazeva 45, Almaty, Kazakhstan. Laboratory assistant of the laboratory of breeding and biotechnology, bachelor of biotechnology; abaizh097@mail.ru; <https://orcid.org/0000-0003-1822-1437>;

Kabyl Zhaparovich Zhambakin: Institute of plant biology and biotechnology. Timiryazeva 45, Almaty, Kazakhstan. General Director of the RSE IPBB KN MES RK, academician of the NAS RK, doctor of biology, professor; zhambakin@gmail.ru; <https://orcid.org/0000-0001-5243-145X>;

Malika Khabidulayevna Shamekova: Institute of plant biology and biotechnology. Timiryazeva 45, Almaty, Kazakhstan. Head of the laboratory of breeding and biotechnology, associate Professor, PhD; m.shamekova@gmail.com; <https://orcid.org/0000-0002-8746-7484>

REFERENCES

- [1] Im JS, Seo SG, Kim MO, Cheon CG, Park YE, Cho JH, Cho KS, Chang DC, Choi JK, Lee JN, Koo BC. (2018) Recent trend and prospects of potato industry in Kazakhstan, J. Kor. Soc. Int. Agric, 30:177-183. doi:10.12719/ksia.2018.30.3.177.
- [2] Food and Agriculture Organization of the United Nations. Available on: <http://www.fao.org/faostat/ru/#data/QC>
- [3] Jeffries C, James C. (2005) Development of an EU protocol for the detection and diagnosis of Potato spindle tuber pospiviroid, EPPO Bulletin, 35:125-132. doi:10.1111/j.1365-2338.2005.00799.x.
- [4] Valkonen JPT (1995) Nuclear DNA content of the *Solanum* spp. in the series *Etuberosa* as determined by laser flow cytometry. Ann. Appl. Bio, 125: 589-600. doi:10.1111/j.1744-7348.1994.tb04995.x.
- [5] Yildirim Z. (1995) Microtuber production in potato (*Solanum tuberosum* L.), The J. Agric. Facul. Ege Univer., 32:73-77. (in Turkish).
- [6] Farran I, Mingo-Castel AM. (2006) Potato minituber production using aeroponics: Effect of plant density and harvesting intervals, Am. J. Pot Res, 83:47-53. doi:10.1007/BF02869609.
- [7] Altindal D, Karadogan T. (2010) The effect of carbon sources on *in vitro* microtuberization of potato (*Solanum tuberosum* L.), Turk. J. Field Crops, 15:7-11.
- [8] Etienne H, Berthouly M. (2002) Temporary immersion systems in plant micropropagation, Plant Cell, Tissue and Organ Culture, 69:215-231. doi: 10.1023/A:1015668610465.
- [9] Kawakami J, Iwama K, Hasegawa T, Jitsuyama Y. (2003) Growth and yield of potato plants grown from microtubers in fields, Am. J. Pot Res, 80:371-378. doi:10.1007/BF02854248.
- [10] Struik PC. (2007) Response of the potato plant to temperature. In D. Vreugenhil (Ed.), Potato biology and biotechnology: advances and perspectives. Elsevier, Amsterdam. P. 367-393. doi: 10.1016/B978-044451018-1/50060-9.
- [11] Lommen WJM, Struik PC. (1995) Field performance of potato minitubers with different fresh weights and conventional seed tubers: Multiplication factors and progeny yield variation, Potato Res, 38:159-169. doi:10.1007/BF02357929.
- [12] Rykaczewska K. (2007) Wpływ różnych wielkości minibuł na plon sadzeniaków i współczynnik rozmnażania wybranych odmian ziemniakaIn: Nasiennictwo i Ochrona Ziemniaka – Abstracts of Papers and Posters, Conference, Kołobrzeg, March 19–20, ZNiOZ IHAR Bonin Poland. P. 101–103. (In Polish)
- [13] Alam M, Banu M, Swaraz A, Parvez S, Hossain M, Khalekuzzaman M, Ahsan N. (2004) Production of virus free seeds using meristem culture in tomato plant under tropical conditions, Journal of Plant Biotechnology, 6:221-227.
- [14] Murashige T, Skoog F. (1962) A revised medium for rapid growth and bio assays with tobacco tissue cultures, Physiologia Plantarum, 15:473-497. <https://doi.org/10.1111/j.1399-3054.1962.tb08052.x>.
- [15] Alam I, Sharmin S, Naher M, Alam MJ, Anisuzzaman M, Alam M. (2010) Effect of growth regulators on meristem culture and plantlet establishment of sweet potato (*Ipomoea batatas* (L.) Lam.), Plant Omics 3:35-39. ISSN:1836-3644
- [16] Akita AM, Takayama S. (1994) Stimulation of potato (*Solanum tuberosum* L.) tuberization by semicontinuous liquid medium surface level control, Plant Cell Reports, 13:184-187. DOI: 10.1007/BF00239889.
- [17] Doyle JJ, Doyle JL. (1987) A rapid DNA isolation procedure from small quantities of fresh leaf tissues, Phytochemical Bulletin, 19:11-15. DOI: 10.1007/s40009-015-0357-5.
- [18] GeneJet Viral DNA/RNA Purification Kit. Available at: <http://www.thermoscientific.com/onebio>.
- [19] cDNA synthesis and RT-PCR Available at: <http://www.sileks.com/ru/production.php?folder=172>.
- [20] BIOREBA Available at: <http://www.bioreba.ch/>

УДК 619:616.98:579.844

Н.П. Иванов¹, Н.Н. Егорова²,
С.Н. Саримбекова², В.Ю. Сущих², А.К. Илимбаева²

ТОО «Казахский научно-исследовательский ветеринарный институт», Алматы, Казахстан.

E-mail: akademik-vet@mail.ru; natalya-egorova60@mail.ru;
sarimbekova@yandex.kz; vladasali@mail.ru; almira577@mail.ru

БИОЛОГИЧЕСКИЕ СВОЙСТВА FUSOBACTERIUM NECROPHORUM, ВЫДЕЛЕННЫХ ИЗ ПОРАЖЕННЫХ ТКАНЕЙ КРС В АЛМАТИНСКОЙ ОБЛАСТИ

Аннотация. Некробактериозом поражаются многие виды животных. Наиболее восприимчивы и чувствительны к *Fusobacterium necrophorum* северные олени, крупный и мелкий рогатый скот, свиньи, кролики. Установлено постоянное носительство возбудителя некробактериоза в рубце и кишечнике жвачных животных, обнаруживают его в частицах корма при жвачке, а также в фекалиях. Возбудитель некробактериоза широко распространен в окружающей среде (животноводческие помещения, выгульные дворы, навоз, почва, пастбища, непроточные водоемы и т.д.). Заражение животных происходит при попадании возбудителя на травмированные участки кожи или слизистые оболочки животных. В результате длительного содержания животных во влажных помещениях, при пастьбе их на сырых, заболоченных участках, а также при мацерации тканей конечностей нарушается кровообращение, возникают трещины, отслоение рога.

От больных животных с симптомами хромоты выделены четыре культуры возбудителя некробактериоза крупного рогатого скота *Fusobacterium necrophorum*, изучены их биологические свойства. Изучена патогенность выделенных культур на лабораторных животных. Работа выполнялась в лабораторных и производственных условиях ТОО «КазНИВИ» и на МТФ населенного пункта с. «Аркабай» Талгарского района Алматинской области, где практикуется стойловое содержание животных. Срезы с больного копыта коров брали на границе больной и здоровой ткани. Пробы отобранного биологического материала высевали на среду Китт-Тароцци на месте отбора на ферме. Отобранный от больных животных биологический материал исследовали в течение нескольких часов после взятия в соответствии с методическими указаниями по лабораторной диагностике некробактериоза. Материал для лабораторного исследования (срезы с роговой ткани копыта на границе со здоровой) отбирали в свежем виде и делали высевы на питательную среду для анаэробов.

Для освобождения от многочисленной сопутствующей микрофлоры и получения чистой культуры *F. necrophorum* поставлена биопроба на лабораторных животных – кроликах. На 14-15 сутки после заражения опытные кролики погибали. Из внутренних органов кроликов высевалась чистая культура *F. necrophorum*, не контаминированная посторонней микрофлорой.

Установлено, что кролики являются оптимальной биомоделью для очищения культуры *F. necrophorum*. Приведены результаты культивирования возбудителя некробактериоза на плотных и жидких питательных средах. Изучены биохимические свойства выделенных культур. Установлено, что эпизоотические культуры возбудителя некробактериоза выделяли сероводород и обладали гемолитическими свойствами. В опытах *in vitro* и *in vivo* установлено, что у выделенных культур *F. necrophorum* отмечена гиалуронидазная активность. Культуры *F. necrophorum* обладали высокой каталазой активностью, расщепляли перекись водорода с образованием кислорода (пузырьков газа). При изучении биохимических свойств установлено, что *F. necrophorum* выделяет аммиак в течение 2-3 часов. Четыре культуры *F. necrophorum*, выделенные из биологического материала от крупного рогатого скота, были идентичны по биологическим свойствам. Все выделенные культуры обладали высокой патогенностью для кроликов.

Ключевые слова: крупный рогатый скот, белые мыши, кролики, животные, биопроба, некробактериоз, культура микроорганизмов.

Введение. Некробактериоз (Necrobacteriosis) – инфекционная болезнь, характеризующаяся гнойно-некротическими поражениями тканей преимущественно нижних частей конечностей, особенно в области венчика, а в отдельных случаях в ротовой полости, на вымени, в половых органах, печени, легких и других тканях и органах.

Возбудитель болезни *Fusobacterium necrophorum* - грамотрицательная полиморфная палочка, не обладают подвижностью, растет в строго анаэробных условиях, не образует спор и капсул. В специальной литературе отсутствуют полные данные о патогенетических факторах, вызывающих некротический процесс в окологрызательных тканях. Исследования по выявлению механизма действия возбудителя болезни на разложение тканей в месте его обитания позволяют более успешно осуществлять борьбу с этим заболеванием.

Эпизоотологические данные. Некробактериозом поражаются многие виды животных. Однако наиболее восприимчивы и чувствительны к *Fusobacterium necrophorum* северные олени, крупный и мелкий рогатый скот, свиньи, кролики и др. [1,2]. Установлено постоянное носительство возбудителя некробактериоза в рубце и кишечнике жвачных животных, обнаруживают его в частицах корма при жвачке, а также в фекалиях. Возбудитель некробактериоза широко распространен в окружающей среде (животноводческие помещения, выгульные дворы, навоз, почва, пастбища, непроточные водоемы и т.д.) [3,4].

Заражение животных происходит при попадании возбудителя на травмированные участки кожи или слизистых оболочек животных. В результате длительного содержания животных во влажных помещениях, при пастбые их на сырых, заболоченных участках, а также при мацерации тканей конечностей нарушается кровообращение, возникают трещины, отслоение рога, т.е. создаются благоприятные условия для проникновения и размножения возбудителя некробактериоза [5]. В части ткани, а затем патологическому действию подвергается венчик и дистальная часть копыта. Течение болезни нередко осложняется развитием секундарной инфекции [6].

Диагноз на некробактериоз устанавливают, в основном, на основании клинических признаков болезни. При этом характерным является наличие гнойно-некротических поражений копыта со специфическим гнилостным запахом. Для подтверждения диагноза на некробактериоз проводят бактериологические исследования с постановкой биопробы [7].

Лечение больных животных осуществляли на специально оборудованных площадках с сухими полами, защищенными от дождя и ветра. Места поражений копыта тщательно очищают, омывают антисептическими растворами и наносят сульфаниламидные препараты или антибиотики тетрациклинового или пенициллинового ряда. Однако отсутствие данных о патогенетических факторах возбудителя сдерживает эффективность оздоровительных мер [8].

Цель исследований - изучение биологических свойств *Fusobacterium necrophorum*, определение факторов патогенности для разработки эффективных способов борьбы с некробактериозом животных.

Материалы и методы. Работа выполнялась в лабораторных и производственных условиях ТОО «КазНИВИ» и на МТФ населенного пункта с. «Аркабай» Талгарского района Алматинской области, где практикуется стойловое содержание животных. Бактериологические исследования проводят общепринятым методом. Отобранный биологический материал исследовали в течение нескольких часов после взятия в соответствии с методическими указаниями по лабораторной диагностике некробактериоза [9]. Материал для лабораторного исследования (срезы с роговой ткани копыта на границе со здоровой) отбирали в свежем виде и делали высевы на питательную среду для анаэробов.

Результаты исследований и обсуждение. Массовость заболевания некробактериозом обусловлена неблагоприятными условиями содержания, ухода и кормления животных, которые способствуют мацерации кожи, венозным застоям в тканях, снижению их резистентности, в результате чего образуются микротравмы и в них внедряется различная аэробная и анаэробная микрофлора.

Все стадии некробактериоза у животных разных групп идентичны и наблюдаются в каждой неблагополучной по некробактериозу эпизоотологической единице. Пробы отбирали с роговой ткани копыта на границе больной и здоровой ткани (рисунки 1,2).



Рисунок 1 – Копыто коровы, пораженное некробактериозом



Рисунок 2– Отбор проб патологического материала у коровы

На рисунке 1 показано копыто коровы, больной некробактериозом. Видны поражения рогового слоя копыта и прилегающей к нему ткани. На рисунке 2 представлен отбор проб из копыта, пораженного некробактериозом. Виден воспалительный процесс копыта и прилегающей к нему ткани. Отобранные от животных с симптомами хромоты пробы высевали, как указано выше, на специальные питательные среды для последующего изучения биологических свойств (культурально-морфологических, биохимических, вирулентных и т.д.), идентификации и типовой принадлежности выделенных культур. Всего от животных с симптомами хромоты выделено 4 эпизоотических культуры *F. necrophorum*.

Из выращенных культур готовили мазки и окрашивали по Граму. *F. necrophorum* в мазке показана на рисунке 3.



Рисунок 3 – *F. necrophorum* в мазке, окрашенном по Граму

На рисунке 3 показаны тонкие длинные грамтрицательные нитеобразные палочки, типичные для возбудителя некробактериоза.

Для получения чистой культуры *F. necrophorum* ставили биопробу на кроликах весом 3-3,5 кг. С этой целью опытным кроликам подкожно в область корня уха вводили суспензию, приготовленную из биологического материала, взятого от больных коров. Биопробу проводили одновременно с посевом материала на питательные среды. Наблюдение за опытными животными осуществляли в течение 10 суток. На месте введения заражающего материала через 3-4 дня или позднее развивался воспалительный процесс с некрозом кожи. Через 4-5 суток у зараженных кроликов наблюдали развитие воспалительного, а через 10-12 суток некротического процессов, рисунок 4.

На рисунке 4 виден воспалительный процесс и некротический очажок у основания уха кролика, зараженного *F. necrophorum*.

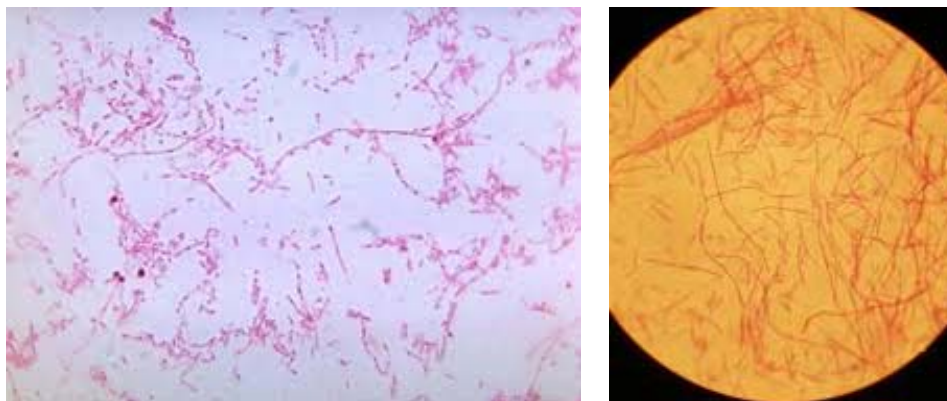
На 14-15 сутки опытные кролики погибали. Из внутренних органов кроликов делали посевы на среду Китт-Тароцци, где отмечался рост чистой культуры *F. necrophorum*.

На агаре Цейсслера в анаэробных условиях через 48 часов культивирования наблюдался обильный рост круглых матовых выпуклых колоний с неровными краями размером от 1 до 3 мм, рисунок 5.



Рисунок 4 – Некроз ткани у основания уха кролика



Рисунок 5 – Рост колоний *F. necrophorum* на плотной питательной среде

На рисунке 5 показаны мелкие круглые матовые колонии *F. necrophorum*.

В мазках, приготовленных из суточной бульонной культуры *F. necrophorum*, просматривались тонкие длинные грамотрицательные нити и палочки, рисунок 6.



Рисунок 6 – *F. necrophorum*, очищенная от сопутствующей микрофлоры в мазке, окрашенной по Граму

На рисунке 6 представлены грамотрицательные тонкие палочки и нити, не контаминированные посторонней микрофлорой.

Определяли способность *F. necrophorum* гидролизовать гиппурат, эскулин, образовывать индол, сероводород, разлагать углеводы с образованием кислоты. Для *F. necrophorum* характерно: отсутствие способности к гидролизу гиппурата, эскулина, образованию кислоты из галактозы, маннозы, целлобиозы, мелибиозы, сахарозы, трегалозы, раффинозы, салицина; возбудитель непостоянно расщепляет глюкозу, дает кислотообразование на среде с фруктозой, сахарозой, мальтозой. Отдельные штаммы *F. necrophorum* могут ферментировать маннит, дульцит, глицерин; расщепляют желатин, не редуцируют нитраты в нитриты, образуют индол и сероводород. Биохимические свойства возбудителя некробактериоза представлены в таблице 1.

Таблица 1- Биохимические характеристики *F. Necrophorum*

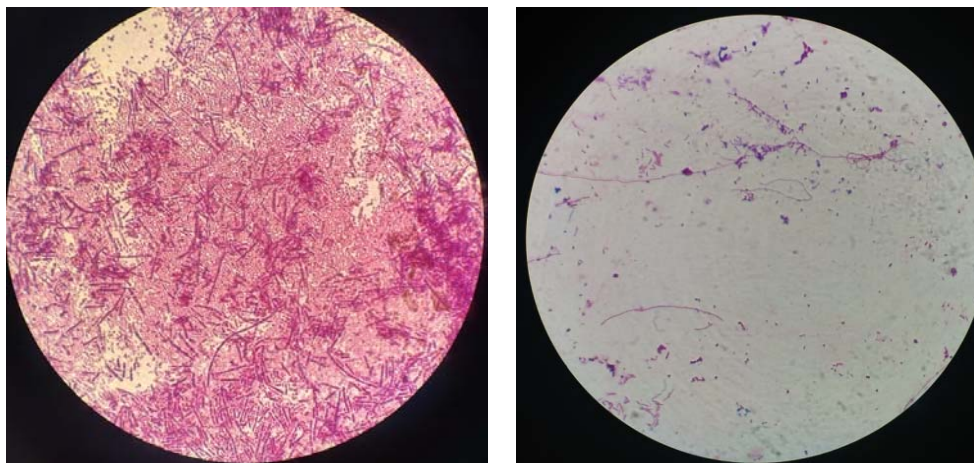
Культура	Наименование углеводов										
	Ман-нит	Глюкоза	Лактоза	Арабиноза	Мальтоза	Сахароза	Рафиноза	Рамноза	Дульцит	Образование газа	Гемолиз
№1	+	+	+	+	+	+	+	+	+	+	+
№2	+	+	+	+	+	+	+	+	+	+	+
№3	+	+	+	+	+	+	+	+	+	+	+
№4	+	+	+	+	+	+	+	+	+	+	+

Условные обозначения: + - наличие ферментативной активности.

Из таблицы 1 видно, что все 4 культуры *F. necrophorum* обладали высокой ферментативной активностью: разлагали с образованием кислоты и газа глюкозу, лактозу, арабинозу, мальтозу, сахарозу, рафинозу, рамнозу, дульцит. Протеолитические свойства выделенных культур *F. necrophorum* показаны в таблице 2.

Таблица 2 – Протеолитические свойства *F. Necrophorum*

Культура	Протеолитические свойства			
	Образование сероводорода	Образование индола	Разжижение желатина	Свертывание молока
№1	+	+	+	-
№2	+	+	+	-
№3	+	+	+	-
№4	+	+	+	-

Условные обозначения:
+ - наличие ферментативной активности; - - отсутствие ферментативной активности.

Из таблицы 2 следует, что все культуры *F. necrophorum* образовывали сероводород и индол, разжижали желатин и не сбраживали молоко. Все 4 эпизоотические культуры возбудителя некробактериоза, выделенные нами от крупного рогатого скота МТФ с. Аркабай Талгарского района Алматинской области, были идентичны по биохимическим свойствам, протеолитической активности и патогенности.

На рисунках 7 и 8 показана протеолитическая активность и гемолитические свойства возбудителя некробактериоза.

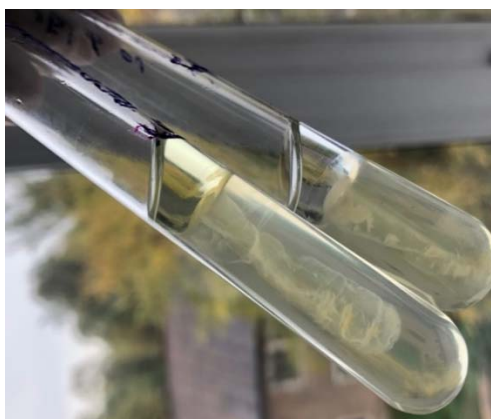
Рисунок 7 – Протеолитическая активность *F. necrophorum*Рисунок 8 – Гемолитические свойства *F. necrophorum*

На рисунке 7 представлено разжижение желатина, *F. necrophorum* интенсивно разжижает желатин. На рисунке 8 показано просветление среды Кит-Тароцци с добавлением крови барана, что свидетельствует о гемолитической активности культуры *F. necrophorum*.

Возбудитель некробактериоза обладал высокой каталазной активностью. Колонию 2-х суточной культуры *F. necrophorum*, выращенную на агаре Цейслера в анаэробных условиях, брали

бактериологической петлей и тщательно растирали в капле свежеприготовленного 3% раствора перекиси водорода на предметном стекле. Через 0,5-1,0 минуту на стекле наблюдалось интенсивное образование пузырьков газа, происходило расщепление H_2O_2 с выделением атомарного кислорода. Определение сероводорода осуществляли с помощью полосок фильтровальной бумаги, пропитанной насыщенным раствором уксусно-кислого свинца. Учет реакции осуществляли через 24 часа выдерживания культуры в термостате. По истечении указанного времени проводили замеры величины потемнения полосок фильтровальной бумаги и делали оценку степени выделения сероводорода изучаемой культурой. Каталазная активность *F. necrophorum* и образование сероводорода показаны на рисунках 9 и 10.



Рисунок 9 – Каталазная активность *F. necrophorum*



Рисунок 10 – Продукция сероводорода *F. necrophorum*

На рисунке 9 видны пузырьки газа при расщеплении *F. necrophorum* перекиси водорода, что свидетельствует о высокой каталазной активности. На рисунке 10 представлена почерневшая фильтровальная бумажка, пропитанная уксусно-кислым свинцом, что свидетельствует об интенсивном образовании *F. necrophorum* H_2S .

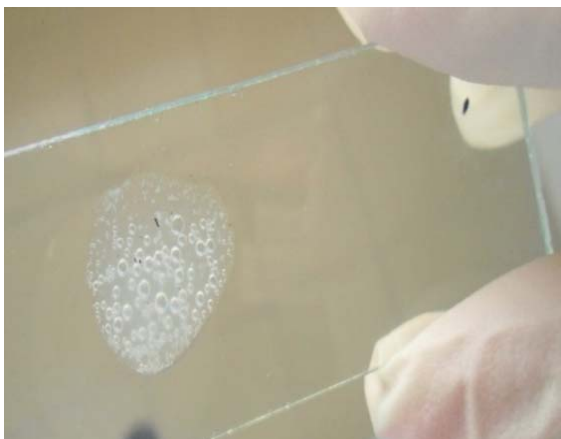
Следующим этапом в изучении биохимических свойств *F. necrophorum* являлось определение уреазной активности. С этой целью производили посеvy *F. necrophorum* на питательную среду Китт-Тароцци с добавлением в 0,002% фенолрота и 2% мочевины (карбамида) с последующим выдерживанием посевов в термостате при 37-38 °С в течение 24 часов. Продукцию аммиака устанавливали визуально по изменению цвета питательной среды от светло-лимонного до красно-малинового. Оценка уреазной активности *F. necrophorum* проводили по четырёх балльной системе:

+++ - полное изменение цвета среды в течение 2 часов роста;

++- красно-малиновый цвет среда приобретала по истечению 4 часов роста;

+ - изменение цвета среды от желто-лимонного до красно-малинового наступало по истечению 8 часов роста бактериальной культуры;

- отсутствие изменений цвета среды в течение 24 часов выдерживания культуры в термостате.

При изучении аммиакообразования *F. necrophorum* отмечалось интенсивное выделение аммиака в течение 2-3 часов, о чем свидетельствовало покраснение среды Китт-Тароцци, рисунок 11.

На рисунке 11 показано покраснение среды Китт-Тароцци вследствие интенсивного выделения аммиака через 2-3 часа после посева *F. necrophorum*. Видно полное изменение цвета среды, окрасившейся в малиновый цвет. Таким образом, нами впервые выявлена способность *F. necrophorum* выделять аммиак, на что выдан охранный документ [10].

Гиалуронидазную активность *F. necrophorum* определяли в опытах *in vitro* и *in vivo*. В 4 пробирки помещали 1%-ный раствор гиалуроновой кислоты (официальный препарат) и добавляли взвесь изучаемой культуры. Для создания анаэробных условий сверху наслаивали вазелиновое масло (высота столбика 1 см) и выдерживали культуру в термостате 12 часов. Проводили оценку степени просветления раствора гиалуроновой кислоты с последующим выдерживанием реактивной смеси в термостате в течение 3-4 часов и затем с добавлением 20%-ного раствора ТХУ, наличие

гиалуронидазной активности у всех выделенных четырех культур. Дополнительно гиалуронидазную активность *F. necrophorum* определяли *in vivo*. С этой целью готовили 8-10 миллиардную бактериальную взвесь культуры и смешивали ее в соотношении 1:1 с 1%-ным раствором трипановой сини, затем вводили кролику - альбиносу весом 3-3,5 кг внутривенно в область спины в дозе 1 см³. Учет у результатов проводили через 12 и 24 часа. Гиалуронидазная активность *F. necrophorum* *in vitro* и *in vivo* видна на рисунках 12 и 13.



Рисунок 11 – Продукция аммиака *F. necrophorum*



Рисунок 12 – Определение гиалуронидазной активности *in vitro*



Рисунок 13 – Определение гиалуронидазной активности *in vivo*

На рисунке 12 видно просветление среды, что свидетельствует о продукции возбудителем некробактериоза гиалуронидазы. На рисунке 13 видно увеличение синего пятна у кролика до размеров 2 см в радиусе через 48 часов после инъекции. Установлено, что *F. necrophorum* обладает широким спектром ферментативной активности. Ферменты возбудителя, в том числе и гиалуронидаза, значительно усиливают и отягощают течение патологического процесса у животных, ускоряют микробное распространение в тканях.

Все четыре эпизоотические культуры *F. necrophorum* обладали высокой патогенностью для кроликов и белых мышей. Опытные животные, как правило, по истечению определенного времени погибали. Патологоанатомические изменения у павших животных были специфичны для

некробактериоза и характеризовались массовыми некротическими очажками и кровоизлияниями во внутренних органах. Отмечались патологические и дистрофические изменения во внутренних животных. От павших животных выделены заражающие культуры *F. necrophorum*, не контаминированные посторонней микрофлорой.

Заключение. В Талгарском районе Алматинской области имеют место случаи некробактериоза у крупного рогатого скота. Возбудителем некробактериоза является *F. necrophorum*, выделенная из биоматериала от больных животных. Культуры *F. necrophorum* обладали высокой патогенностью для лабораторных животных. Все четыре культуры *F. necrophorum*, выделенные от больных некробактериозом коров, обладали высокой ферментативной активностью: разлагали с образованием кислоты и газа глюкозу, лактозу, арабинозу, мальтозу, сахарозу, рафинозу, рамнозу, дульцит.

Культуры *F. necrophorum* продуцировали сероводород, выделяли аммиак, обладали протеолитической, каталазной, гиалуронидазной и гемолитической активностью, являющихся факторами патогенности возбудителя некробактериоза.

Биологические свойства и особенности *F. necrophorum* будут использованы при разработке терапевтических и профилактических препаратов при некробактериозе животных.

**Н.П. Иванов¹, Н.Н. Егорова²,
С.Н. Саримбекова², В.Ю. Суших², А.К. Илимбаева²**

«Қазақ ғылыми-зерттеу ветеринария институты» ЖШС, Алматы, Қазақстан

**АЛМАТЫ ОБЛЫСЫНДАҒЫ ІРІ ҚАРА МАЛДЫҢ
ИНФЕКЦИЯЛАНҒАН ТІШІНЕН БӨЛІНГЕН
FUSOBACTERIUM NECROPHORUM БИОЛОГИЯЛЫҚ ҚАСИЕТТЕРІ**

Аннотация. Некробактериоз (некробактериоз) – тұяқ ұлпаларының ірінді-некротикалық зақымданатын инфекция ауруы, әсіресе, тұяқ ашасында, ал кейбір жағдайда ауыз қуысы, желін, жыныс мүшесі, бауыр, өкпе және басқа ағзаларда кездеседі.

Көптеген жануар түрлері некробактериозға бейім болып келеді. *Fusobacterium necrophorum*-ға бұғы, ірі қара және ұсақ күйіс қайыратын жануарлар, шошқа және қояндар сезімтал болып келеді.

Некробактериоз қоздырушысының тұрақты тасымалдаушысы күйіс қайыратын малдың ішегі мен қарнында пайда болып, ол күйіс қайыру кезінде азық бөлшектері, нәжіс, сыртқы орта объектілерінде кездеседі. Ауру, әсіресе, зоогигиеналық жағдайы нашар ылғалды жерде ұсталатын жануарларда жиі байқалады. Жануарлар инфекциясын қоздырушы зақымданған теріге немесе шырышты қабықтан енгенде қабықтың мацерациясында пайда болады.

Жұмыс «ҚазҒЗВИ» ЖШС-нің зертханалық және өндірістік жағдайында және Алматы облысы Талғар ауданы «Арқабай» елдімекенінің МТФ-да жануарды қорада күтіп-бағу жағдайында жүргізілді.

Зертханалық зерттеуге арналған материал (тұяқ ұлпасы зақымданған тұстың сау ұлпасы арасындағы шекарасы) жаңа алынған және анаэробтарға арналған қоректік ортаға (Китт-Тароцци ортасы) себілді.

Таңдалған биологиялық материалдың үлгілері фермадағы зертханада Китт-Тароцци ортасына егілді. Ауру жануарлардан алынған биологиялық материал некробактериоздың зертханалық балау жөніндегі нұсқаулыққа сәйкес алынғаннан кейін бірнеше сағат ішінде зерттелді.

Көптеген ұқсас микрофлорадан арылу үшін және *F. necrophorum* таза өсіндісін бөліп алу үшін зертханаға алынған қояндарға биоанализ жасалды. Инфекциядан кейін 14-15-күні оқшауланған өсінділердің жоғары патогенділігінің әсерінен тәжірибеге алынған қояндар өлді. Қоянның ішкі ағзаларына бөгде микрофлорамен ластанбаған таза *F. necrophorum* өсіндісі егілді.

Қоянның *F. necrophorum* өсінділерін тазарту үшін оңтайлы биомодель екендігі анықталды. Некробактериоз қоздырушысын қатты және сұйық қоректік ортада өсіру нәтижелері келтірілді. Оқшауланған өсінділердің биохимиялық қасиеттері зерттелді. Ірі қара малдағы некробактериоз қоздырушысының індет өсінділері күкіртсутек бөліп, аммиак түзіп, гемолитикалық қасиетке ие екендігі анықталды. *In vitro* және *in vivo* тәжірибеде *F. necrophorum* оқшауланған өсінділерінің гиалуронидазаға белсенділігі көрсетілгені дәлелденді. *F. necrophorum* өсінділері жоғары каталаза белсенділігін көрсетті, яғни газ көпіршіктерінің және сутегі асқын тотығының бөлінуі негізінде сипатталады. Биологиялық материалдан ірі қара малдан оқшауланған *F. necrophorum* төрт өсіндісі биологиялық қасиеті бойынша ұқсас болды.

Түйін сөздер: ірі қара мал, қоян, жануар, биосынама, некробактериоз, микроорганизм.

¹ N.P. Ivanov, ² N.N. Egorova,
² S.N. Sarimbekova, ² V. Yu Sushi, ² A.K. Ilimbayeva

LLP «Kazakh scientific-research veterinary institute», Almaty, Kazakhstan

BIOLOGICAL PROPERTIES OF FUSOBACTERIUM NECROPHORUM ISOLATED FROM INFECTED CATTLE TISSUES IN ALMATY REGION

Abstract. Necrobacteriosis (necrobacteriosis) is established as an infectious disease characterized by purulent-necrotic lesions of tissues mainly of the lower parts of the extremities, especially in the area of the corolla, and in some cases in the oral cavity, on the udder, in the genitals, liver, lungs and other tissues and organs.

Many animal species are affected by necrobacteriosis. The most susceptible and sensitive to *Fusobacterium necrophorum* are reindeer, cattle and small ruminants, pigs, and rabbits.

A constant carrier of the causative agent of necrobacteriosis in the rumen and intestines of ruminants has been established, it is found in food particles during chewing, in feces, in objects of the external environment. The disease is especially often observed in animals kept in damp places with poor zoohygienic conditions.

Infection of animals occurs when the pathogen enters the injured skin areas or when the mucous membranes are macerated.

The work was carried out in the laboratory and production conditions of KazSRVI LLC and at the MTF of the Arkabay settlement of the Talgar district of the Almaty region, where stall keeping of animals is practiced.

Material for laboratory research (sections from the horny tissue of the hoof on the border with the healthy one) were taken fresh and inoculated on a nutrient medium for anaerobes (Kitt-Tarozzi medium).

Samples of the selected biological material were plated on Kitt-Tarozzi medium at the sampling site on the farm. The biological material taken from sick animals was examined within several hours after taking in accordance with the guidelines for laboratory diagnostics of necrobacteriosis (YEAR INDICATION METHOD).

To get rid of the numerous accompanying microflora and obtain a pure culture of *F. necrophorum*, a bioassay was set up on laboratory animals - rabbits. On the 14-15th day after infection, the experimental rabbits died, which is evidence of the high pathogenicity of the isolated cultures. A pure culture of *F. necrophorum* from rabbit's internal organs, not contaminated with extraneous microflora, was cultured.

It was found that rabbits are the optimal biomodel for purification of the *F. necrophorum* culture. The results of cultivation of the causative agent of presented necrobacteriosis on solid and liquid nutrient media are. The biochemical properties of the isolated cultures have been studied. It was found that epizootic cultures of the causative agent of necrobacteriosis in cattle emitted hydrogen sulfide, formed ammonia, and had hemolytic properties. In experiments in vitro and in vivo, it was found that the isolated cultures of *F. necrophorum* showed hyaluronidase activity. Cultures of *F. necrophorum* had high catalase activity, i.e. split hydrogen peroxide with the release of gas bubbles. Four cultures of *F. necrophorum*, isolated from biological material from cattle, were identical in biological properties.

Keywords: a cattle, rabbit, animals, bioassay, necrobacteriosis, culture of microorganisms.

Information about authors:

Ivanov N.P., Doctor of Veterinary Sciences, Academician of the National Academy of Sciences of the Republic of Kazakhstan, Chief Researcher of LLP «Kazakh scientific-research veterinary institute», Almaty, Kazakhstan; akademik-vet@mail.ru; 0000-0003-1964-241X;

Yegorova N.N., Candidate of Veterinary Sciences, Senior Researcher of LLP «Kazakh scientific-research veterinary institute», Almaty, Kazakhstan; natalya-egorova60@mail.ru; 0000-0001-9525-1854;

Sarimbekova S.N., Master of Veterinary Science, Almaty, Kazakhstan; sarimbekova@yandex.kz; 0000-0002-9625-5467;

Sushchikh V.Yu., Candidate of Veterinary Sciences, Leading Researcher of LLP «Kazakh scientific-research veterinary institute», Almaty, Kazakhstan; vldasali@mail.ru; 0000-0002-3520-2257;

Ilimbaeva A.K., Junior Researcher of LLP «Kazakh scientific-research veterinary institute», Almaty, Kazakhstan; almira577@mail.ru; 0000-0002-9847-564X

ЛИТЕРАТУРА

1] Дука О.Н., Култаев Б.Т. Приоритет – животноводство//Известия Национальной академии наук Республики Казахстан. 6 (12). 2012. С. 3-7.

[2] Инфекции наружных покровов// URL: <http://www.bibliotekar.ru/med-3/47.htm>.

[3] Клостридии// URL: http://www.amilguseynov.narod2.ru/chastnaya_mikrobiologiya/lektcii/klostridii, С. 41-42.

[4] Кисленко В. Н. Практикум по ветеринарной микробиологии и иммунологии. М., Колос. 2005. 232 с.

[5] Гуславский И.И., Апалькин В.А., Густокашин К.А. г Краевая эпизоотология инфекционных болезней, основы прогнозирования, профилактики и борьбы с ними // Учебное пособие. Барнаул, 2004. 148 с.

[6] Powell Jr. Foot Rot Can Affect Gain// URL: <http://www.mafg.net/AgriDataArticles.aspx.ArticleID>

[7] Чуднов И.Е., Маневский Г.А., Эккерт В.Ю. Болезнь копыт крупного рогатого скота, некробактериоз//Альманах мировой науки.1. 2015. С. 46-47.

[8] Хузин Д.А., Макаев Х.Н., Папуниди К.Х. Пути оздоровления хозяйств от болезней пальцев, копыт и некробактериоза//Ветеринария сегодня. 4. 2013. С. 22-24.

[9] Антонов Б.И. и др. Справочник Лабораторные исследования в ветеринарии. Бактериальные инфекции. М.: Агропромиздат, 1986. С.56-58.

[10] Свидетельство о внесении сведений в государственный реестр прав на объекты, охраняемые авторским правом Республика Казахстан, Методика обнаружения протеолитических (некротических) свойств *F. necrophorum*/ Иванов Н.П., Суших В.Ю., Илимбаева А.К., Саримбекова С.Н. - №9054, опубл. 30.03.2020.

REFERENCES

1] Duka O. N., Kultaev B. T. Priority - animal husbandry // News of the National Academy of Sciences of the Republic of Kazakhstan. 6 (12). 2012. С. 3-7.

[2] Infections of the outer integument // <http://www.bibliotekar.ru/med-3/47.htm>.

[3] Clostridia // URL: http://www.amilguseynov.narod2.ru/chastnaya_mikrobiologiya/lektcii/klostridii, S. 41-42.

[4] Kislenco V. N. Workshop on veterinary microbiology and immunology. М., Kolos. 2005. 232 p.

[5] Guslavsky I.I., Apalkin V.A., Gustokashin K.A. Regional epizootology of infectious diseases, the basics of forecasting, prevention and control of them // Textbook. Barnaul, 2004. 148p.

[6] Powell Jr. FootRot Can Affect Gain// URL: <http://www.mafg.net/AgriDataArticles.aspx.ArticleID>

[7] Chudnov I. E., Manevsky G. A., Ekkert V. Yu. Disease of cattle hooves, necrobacteriosis// Almanac of world science. 1. 2015. Pp. 46-47.

[8] Khuzin D. A., Makaev Kh. N., Papunidi Kh. Ways of improving farms from diseases of fingers, hooves and necrobacteriosis//Veterinary medicine today. 4. 2013. Pp. 22-24.

[9] Antonov B.I. and other Directory Laboratory research in veterinary medicine. Bacterial infections. М.: Агропромиздат, 1986.- P.56-58.

[10] Certificate of entering information into the state register of rights to objects protected by copyright Republic of Kazakhstan, Methods for detecting proteolytic (necrotic) properties of *F. necrophorum* /Ivanov N.P., Sushchikh V.Yu., Ilimbaeva A.K., Sarimbekova S.N. - No. 9054, publ. 03/30/2020.

У.Чоманов, Т.Ч. Тултабаева, А.Е. Шоман, А.К. Шоман, Б.Ч.Тултабаев

Казахский научно-исследовательский институт перерабатывающей
и пищевой промышленности, Алматы, Казахстан.

E-mail: chomanov_u@mail.ru, tamara_tch@list.ru,
shoman_aruzhan@mail.ru, a.tultabayeva@rpf.kz, baha-baha63@mail.ru

ИССЛЕДОВАНИЕ БИОТЕХНОЛОГИЧЕСКИХ ПРОЦЕССОВ ПРИ ПРОИЗВОДСТВЕ ЙОГУРТА НА ОСНОВЕ КОБЫЛЬЕГО МОЛОКА

Аннотация. Одно из перспективных направлений биотехнологии – использование физиологически активных симбиозов из различных видов бактерий при создании новых диетических продуктов. Подбор физиологически совместимых штаммов при соблюдении условий оптимизации соотношений чистых культур молочнокислых бактерий является базой для активных симбиозов на основе этих бактерий. В результате проведенных исследований установлено, консорциум для закваски состоит из *S. Thermophilus* и *L. bulgaricus* в соотношении 1:5 для получения их соотношения в готовом продукте 1:10. Оптимальная доза внесения растительной биодобавки составляет 10%, что обусловлено хорошими биохимическими и органолептическими показателями.

Ключевые слова: кобылье молоко, заквасочные культуры, процесс сквашивания.

Введение. В последние годы в индустрии питания появляются прогрессивные технологии, позволяющие создавать новые поколения пищевых продуктов с высокими вкусовыми и лечебно-профилактическими свойствами, хорошей сбалансированностью состава. Использование таких технологий способствует расширению ассортимента высококачественных молочных продуктов, повышению их конкурентоспособности [1].

Издавна известно, что кобылье молоко является натуральным продуктом питания и обладает необходимым набором полезных компонентов в естественно усвояемой форме. Кобылье молоко до настоящего времени не было оценено по достоинству касательно его полезных свойств и биологической ценности.

В настоящее время в условиях пандемии с экономической точки зрения целесообразно организовать массовое производство и переработку кобыльего молока. Переработка кобыльего молока в промышленных масштабах не удовлетворяет и 10% внутренней потребности.

Из кобыльего молока производят кумыс. Действие кумыса на организм человека многогранно. Он в более короткий срок, чем лекарства, улучшает аппетит, регулирует сон, деятельность пищеварительных желёз и отправление кишечника. Кумыс обладает антибактериальной активностью. Это самая сильная биологическая ценность данного продукта. Он оказывает бактерицидное и бактериостатическое действие на возбудителей туберкулёза и кишечных инфекций. Научные и клинические исследования свидетельствуют о высокой активности кумыса при лечении язвенной болезни желудка и двенадцатиперстной кишки, хронического гастрита и хронического энтероколита, функциональных расстройств желчного пузыря и толстой кишки, хронических неспецифических заболеваний лёгких, атеросклероза, гипертонии. Отмечены хорошие результаты курсового лечения кумысом при функциональных расстройствах центральной и вегетативной нервной системы, при заболеваниях сердечно-сосудистой и кровеносной систем. Кумыс увеличивает уровень гемоглобина в крови, способствует исчезновению гиповитаминоза, повышает защитные силы организма [2].

Учитывая вышеизложенное и уникальный состав, лёгкую усвояемость и диетические свойства кобыльего молока, нерационально использовать это сырьё только на производство кумыса. Оно может с успехом служить основой для производства специализированных молочных продуктов для детского и диетического питания [3, 4].

Использование кобыльего молока для производства разнообразных кисломолочных продуктов на его основе сдерживается слабой изученностью вопросов технологии переработки молочного сырья, стабилизации химического состава и технологических свойств кобыльего молока.

Методы исследования

Для производства йогурта используют следующие виды сырья:

- молоко коровье сырое не ниже второго сорта по ГОСТ Р 52054-2003 кислотностью не более 20°Т;
- молоко кобылье по СТ РК 1005-98 «Молоко кобылье. Требования при закупках»;
- овощные биодобавки (морковная и тыквенная);
- закваски прямого внесения, состоящие из термофильного молочнокислого стрептококка и молочнокислой болгарской палочки по ТР ТС 033/2013, ТР ТС 021/2011.

Исследование качественных характеристик проводили общепринятыми методами.

Результаты и их обсуждение. Производство ферментированных молочных продуктов основано на использовании бактериальных заквасок, микрофлора которых осуществляет сбраживание лактозы и обеспечивает контролируемый уровень молочнокислого брожения. Размножение заквасочных культур приводит не только к формированию органолептических показателей молочных продуктов, но и к подавлению микроорганизмов порчи, обеспечивая биозащиту продукта. В связи с этим, изучение эффективности использования заквасочных культур на технологические свойства кисломолочных продуктов является актуальной задачей [5-8].

Таким образом, ключевую роль в обеспечении качества кисломолочных продуктов играют заквасочные культуры. При подборе культур для заквасок необходимо придерживаться следующих требований, таких как вкус, консистенция конечного продукта, активность кислотообразования, фагорезистентность штаммов, способность к синерезису, образованию ароматических веществ сочетаемость штаммов и наличие антибиотических свойств [9-11].

В таблице 1 приведена информация о составе бактериальных и смешанных заквасок и условиях получения сквашенного продукта.

Таблица 1 - Основные виды заквасок для производства кисломолочных продуктов

Закваски	Микроорганизмы	Продукты	Температура сквашивания t, °С
Бактериальные			
Мезофильные молочнокислые стрептококки	Lac. lactis, Leu. cremoris, Lac. cremoris, Lac. diacetylactis	Творог, сметана, простокваша	20–30
Термофильные молочнокислые бактерии	Str. thermophilus, Lbm. bulgaricum, Lbm. acidophilum, Lbm. helveticum, Lbm. lactis	Мечниковская и южная простокваши, ряженка, ацидофилин	40–45
Смешанные			
Бактериально-грибковые	Lac. lactis, Lbm. buchtri, Lbm. acidophilum, дрожжи Saccharomyces lactis	Кефир, кумыс	18–22

Нами проведены исследования, связанные с созданием консорциума симбиотических заквасок на основе штаммов *Streptococcus thermophilus* и *Lactobacillus bulgaricus* с целью их использования в производстве йогуртов на основе кобыльего молока.

Введение в состав закваски *Str.thermophilus* и *Lactobacillus bulgaricus* способствует повышению вязкости продукта, придает сгустку эластичные свойства, препятствует выделению сыворотки. Так, путем подбора состава заквасок можно регулировать свойства сгустка и обеспечить оптимальную консистенцию и вкус кисломолочных продуктов.

Для определения влияния вида и количества заквасочных культур при производстве кисломолочных продуктов на основе кобыльего молока, нами был составлен консорциум микроорганизмов закваски, вносимой в количестве 1-1,5% от массы молочной смеси. Далее исследовали различные соотношения микроорганизмов: болгарской палочки и термофильного стрептококка – 1:2, 1:5 и 1:10.

Во всех опытных образцах наблюдается уменьшение значений pH в процессе термостатирования (рисунок 1). Активная кислотность образца 1:10 выше, чем у других показателей, что объясняется преобладанием в консорциуме термофильного стрептококка, который относится к слабым кислотообразователям. Все образцы отмечались высокими органолептическими показателями: приятный, чистый и кисломолочный вкус. В особенности вкус выражен для опытных вариантов с соотношением 1:2 и 1:5, поэтому нами были проведены исследования методом микрокопирования для определения оптимального соотношения микроорганизмов.



Рисунок 1 – Зависимость активной кислотности опытных образцов от продолжительности сквашивания

Важный момент технологического процесса производства различных молочнокислых продуктов – свертывание молока, проявляющееся в образовании молочного сгустка. В целях выбора оптимальных сочетаний лактобактерий, влияющих на характер формирующегося сгустка, на основе их биологических и технологических характеристик мы составили 3 варианта консорциума микроорганизмов.

Зависимость соотношения палочек и кокков в йогурте от их соотношения в закваске показано в таблице 2.

Таблица 2 – Зависимость соотношения *Lact. Bulgaricus* и *Str. thermophilus* в йогурте от их соотношения в закваске

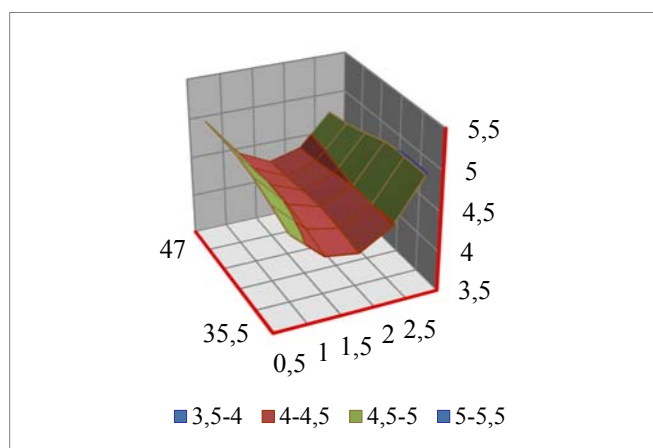
Соотношение <i>Lact. Bulgaricus</i> и <i>Str. thermophilus</i>			
В закваске	1:2	1:5	1:10
В йогурте	1:5	1:10	1:15

По данным Королевой Н.С., установлено, что в йогурте, соотношение *Lact. Bulgaricus* и *Str. thermophilus* должно составлять 1:10 [7]. Таким образом, оптимальное соотношение микроорганизмов в закваске при производстве йогурта достигается при использовании композиции 1:5.

Далее была изучена динамика соотношения культур в йогурте в процессе культивирования в течение 12 ч (таблица 3, рисунок 2).

Таблица 3– Соотношение *Lact. Bulgaricus* и *Str. thermophilus* в йогурте в процессе сквашивания

Продолжительность сквашивания, ч	0	4	6	8	12
Соотношение <i>Lact. Bulgaricus</i> и <i>Str. thermophilus</i>	1:5	1:15	1:10	1:9	1:3

Установлено, что ферментирование в течение 6 ч приводит к увеличению доли *Lact. Bulgaricus* в продукте более 1:10, а через 12 ч модуль палочек и кокков в йогурте становится 1:3 и продукт получается кислым.



Рисунок 2 – Влияние дозы вносимой закваски на продолжительность сквашивания йогуртов

В результате проведенных исследований установлено, что 6 часов - достаточная продолжительность сквашивания, после чего кисломолочный продукт должны помещать в холодильную камеру для охлаждения и избежание нарастания кислотности и отделения сыворотки от сгустка.

Одним из показателей, характеризующих качество закваски, является ее активность, напрямую связанная с кислотностью. При повышенной кислотности активность закваски снижается, что увеличивает продолжительность свертывания молока и ухудшает качество готового продукта.

При производстве йогуртов на основе кобыльего молока для детского и диетического питания, мы в качестве растительной добавки использовали тыквенную и морковную биодобавки.

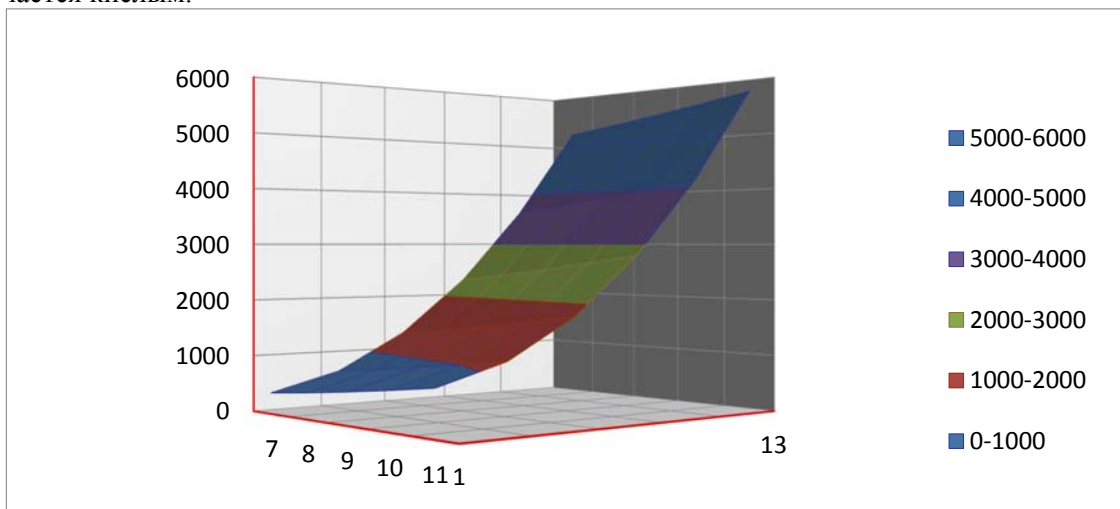
Далее проводили исследования по изучению влияния биодобавок на эффективность кислотообразования микрофлоры опытных образцов и продолжительности сквашивания. Измерение активной и титруемой кислотности проводили каждые 2 часа в течение 8 часов. Среднее арифметическое трех повторностей активной кислотности приведены в таблице 4, а результаты титруемой кислотности и продолжительности сквашивания на рисунках 3 и 4.

Таблица 4 – Изменение активной кислотности в процессе сквашивания кисломолочных продуктов

Опытные образцы йогурта	Значение активной кислотности, ед.рН						
	Контроль	с морковной биодобавкой, %			с тыквенной биодобавкой, %		
		5	10	15	5	10	15
После внесения закваски	6,21	6,20	6,21	6,22	6,20	6,21	6,22
Через 2 ч	6,12	6,15	6,16	6,17	6,14	6,15	6,16
Через 4 ч	5,90	5,91	5,93	5,96	5,92	5,94	5,96
Через 6 ч	5,70	5,71	5,72	5,74	5,72	5,73	5,75
Через 8 ч	4,00	4,01	4,02	4,03	4,01	4,02	4,03

Из таблицы 4 видно, что между значениями активной кислотности контрольного и опытных образцов йогуртов с растительными биодобавками сильных различий нет. Отмечено, что во всех образцах идет стабильное нарастание кислотности, поэтому можно сказать, что внесение растительных биодобавок не оказывает существенного влияния на изменения рН, чего нельзя сказать о титруемой кислотности (рисунок 3).



Рисунок 3 – Влияние растительных биодобавок на титруемую кислотность

Из рисунка 3 видно, что максимальная разница значений титруемой кислотности была отмечена через 6 часов сквашивания, так, например, в образцах с 15% биодобавкой, титруемая кислотность нарастает интенсивнее, по сравнению с контролем, тем самым сокращая процесс ферментации.

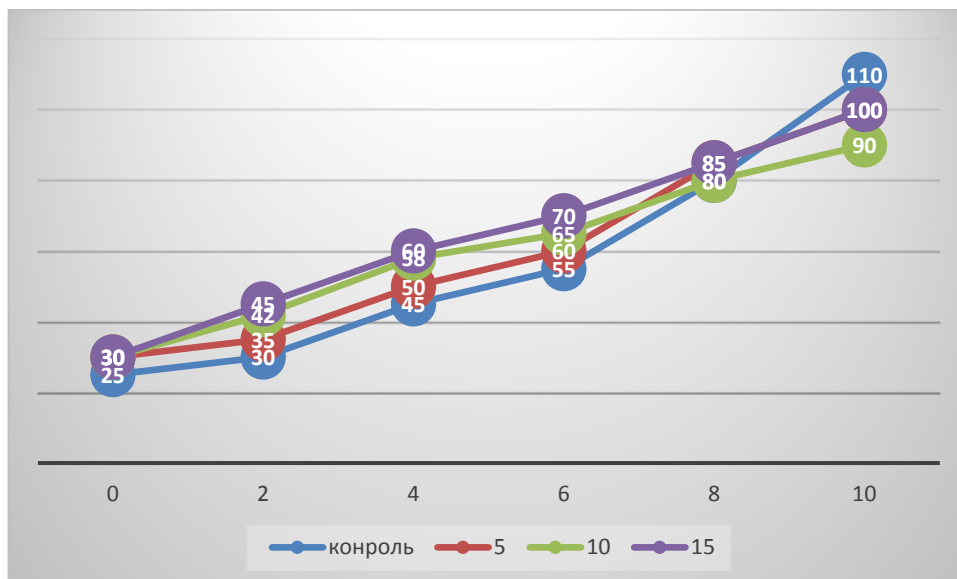

Рисунок 4 – Влияние вносимой растительной биодобавки на продолжительность сквашивания

Оптимальной дозой вносимой растительной добавки является 5-10%, а продолжительность сквашивания составляет 4-6 часов, как видно из графика, оптимальная зона окрашена в желтый цвет.

Анализируя данные, приведенные выше, можно определить, что увеличение дозы вносимой растительной биодобавки отражается на органолептических показателях, а также влияет на изменение активной и титруемой кислотности кисломолочных продуктов. Оптимальным количеством внесения растительной биодобавки установлено 5-10%, что обусловлено хорошими органолептическими качествами и кислотностью. Установлено, что использование растительной биодобавки позволяет сократить процесс сквашивания и получить молочные продукты с хорошими органолептическими показателями (таблица 5).

Таблица 5 – Органолептические показатели йогуртов на основе кобыльего молока с растительными биодобавками

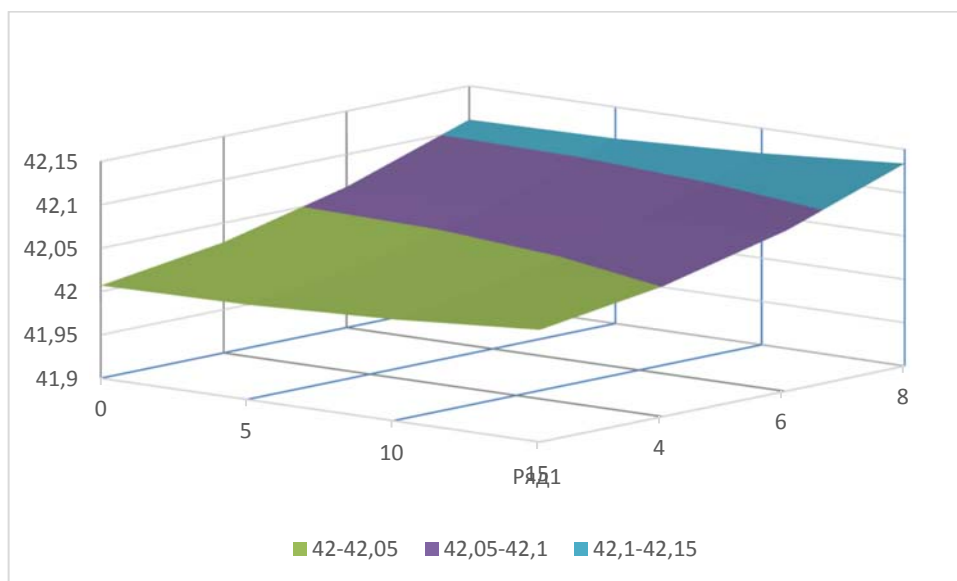
Продукт	Вкус и запах	Цвет	Внешний вид и консистенция
Йогурт без добавки	Чистый, кисломолочный, без посторонних привкусов и запахов.	Молочно-белый	Однородная, слабовязкая и тягучая.
Йогурт с морковной биодобавкой	Чистый, кисломолочный. Вкус в меру сладкий, с легким морковным привкусом.	Слегка оранжевый	Однородная, вязкая и тягучая.
Йогурт с тыквенной биодобавкой	Чистый, кисломолочный. Вкус в меру сладкий, с легким тыквенным привкусом.	Слегка желтоватый	Однородная, вязкая и тягучая.

Таким образом, нами были определены оптимальные дозы внесения растительных биодобавок. Было установлено положительное использование растительной биодобавки в количестве 5 и 10% от массы комбинированной молочной смеси, а также, что использование растительной биодобавки позволяет сократить процесс сквашивания на 1-2 часа и получить молочные продукты с хорошими органолептическими показателями.

Вывод. Анализ данных свидетельствует о том, что оптимальная доза внесения закваски составляет 1%, состоящей из *S. Thermophilus* и *L. bulgaricus* в соотношении 1:5 для получения их соотношения в готовом продукте 1:10.

Увеличение дозы вносимой растительной биодобавки отражается на органолептических показателях, а также влияет на изменение активной кислотности кисломолочных комбинированных продуктов. Оптимальным количеством внесения растительной биодобавки установлено 10%, что обусловлено хорошими органолептическими качествами и активной кислотности (pH 4,63).

У. Чоманов, Т.Ч. Тултабаева, А.Е. Шоман, А.К. Шоман, Б.Ч. Тултабаев

Қазақ қайта өңдеу және тамақ өнеркәсібі ғылыми-зерттеу институты, Алматы, Қазақстан

БИЕ СҮТІ НЕГІЗІНДЕ ЙОГУРТ ӨНДІРУДЕГІ БИОТЕХНОЛОГИЯЛЫҚ ПРОЦЕСТЕРДІ ЗЕРТТЕУ

Аннотация. Мақалада сиыр сүтінен дайындалған балалар тағамы нарығындағы қиындықтарды, сондай-ақ бие сүтінің (саумал) химиялық құрамы мен биологиялық қасиеттерін ескере отырып, түрлі жастағы бала тағамындағы емдік-профилактикалық қасиеті бар аталған ұлттық тамақ өнімін пайдалану үшін алғышарттар жасалады. Осыған байланысты бие сүтін балалар тағамында қолдану, сондай-ақ бие сүті негізінде балалар тағамын өндіру мәселелерін шешу жолдары Ресейде, Еуропада және Қазақстанда зерттеу сатысында тұр.

Балаларды жоғары сапалы биологиялық толыққанды тамақ өнімдерімен қамтамасыз ету мәселесі, әсіресе, елдің көптеген аймағындағы экологиялық жағдайдың нашарлауына, тамақтану сапасының бұзылуына байланысты үлкен әлеуметтік және ұлттық экономикалық мәнге ие. Әдебиеттердегі дереккөздерді талдау барысында қоспалар арқылы балалар мен диеталық тағамдардың аралас өнімдерінің сапалық құрамындағы әсерді зерттеу ТМД елдерінде де, алыс шетелдерде де өзекті бағыт болып саналады.

Қышқыл сүт өнімдерінің сапасы және олардың ерекше қасиеттері өндіріс барысындағы микробиологиялық процестерге байланысты. Қышқыл сүт өнімі микрофлорасының құрамы дәмін анықтайды және олардың қалыптасуында маңызды саналады. Қышқыл сүт өнімдерінің басты артықшылығы – ішек микрофлорасының қалыпқа келуіне ықпал ететін, шіріген микроорганизмдердің дамуын тежейтін, адамның иммунитетін қалыптастыратын және метаболизмді жақсартатын тірі микроорганизмдердің болу жағдайы. Сонымен қатар, сүт қышқылы суындары әдеттегі сүтпен салыстырғанда сіңімді болады. Сондықтан қышқыл сүт өнімдерінің сапасы және олардың адам денсаулығы үшін құндылығы тірі микрофлораға қатысты.

Ашытқыны таңдау барысында қолдану әдісіне, микрофлораның түрлік құрамына назар аудару керек, өйткені ашыған сүт өнімдерінің дәмі мен консистенциясы ашытқының құрамына байланысты болып келеді. Сондықтан, жұмыстың мақсаты бактериялық дақылдар консорциумын қолдана отырып, балалар мен диеталық тамақтануға арналған өсімдік қоспаларымен байытылған бие сүтінен аралас сүт өнімдерін өндіру кезінде биотехнологиялық процестерге зерттеу жүргізілді.

Жұмыстың ғылыми жаңалығы өсімдік шикізатынан және микроорганизмдер консорциумынан биологиялық белсенді қоспасы бар бие сүті негізінде балалар мен диеталық тамақтану үшін сүт өнімдерін

өндірудің оңтайлы биотехнологиялық режимдерін әзірлеу болып саналады. Зерттеу нәтижесінде балалар мен диеталық тағамдарға арналған біріктірілген қышқыл сүт өнімдерін өндіруге арналған сүт-өсімдік қоспасының физика-химиялық көрсеткішіне өсімдік қоспасының түрі мен мөлшерінің әсері анықталды. Бие сүті негізінде балалар мен диеталық тағамдарға арналған өнімдерді өндіру үшін ашыту дақылдары іріктелді және сүт қоспасына өсімдік биодіқосымшасын енгізудің оңтайлы дозасы 10% мөлшерде белгіленді.

Түйін сөздер: бие сүті, ашытқы, ашыту процесі.

U. Chomanov, T. Tultabayeva, A.Y. Shoman, A.K. Shoman, B. Tultabayev

Kazakh research institute of processing and food industry, Almaty, Kazakhstan

RESEARCH OF BIOTECHNOLOGICAL PROCESSES IN THE PRODUCTION OF YOGURT BASED ON MARE'S MILK

Abstract. Given the complexity of the baby food market, which is mainly made of cow's milk, as well as the chemical composition and biological properties of Mare's milk (saumal) are prerequisites for using the national food product with known curative properties in the diet of children of all ages. In this regard, the solution of the issues of widespread use of Mare's milk in the nutrition of children, as well as the production of baby food based on Mare's milk is under study and research in Russia, Europe and Kazakhstan.

The problem of providing children with high-quality biologically complete food is of great social and economic importance, especially in connection with the deterioration of the environmental situation in many regions of the country, the widespread violation of the food structure. According to the analysis of literature sources, the study of the directed impact on the quality of combined products of children's and dietary nutrition through additives is an actual direction both in the CIS countries and in the far abroad.

The quality of fermented milk products and their specific properties depend on the microbiological processes that occur during production. The composition of the microflora of a fermented milk product determines its taste qualities and plays a major role in their formation. The main advantage of fermented milk products is the presence of living microorganisms that contribute to the normalization of intestinal microflora, inhibit the development of putrid microorganisms, form the human immune system, and improve metabolism. In addition, lactic acid drinks, in comparison with ordinary milk, have almost complete digestibility. Therefore, the quality of fermented milk products and their value for human health depend on the presence of living microflora.

When choosing sourdough, it is necessary to pay attention to the method of application, the specific composition of the microflora, since the taste and consistency of fermented milk products depends on the composition of sourdough.

In this regard, the aim of the work was to conduct research on biotechnological processes in the production of combined dairy products from Mare's milk, enriched with plant additives for children's and dietary nutrition using a consortium of bacterial cultures.

The scientific novelty of the work is the development of optimal biotechnological modes of production of dairy products for children and dietary nutrition based on Mare's milk with a biologically active additive from plant raw materials and a consortium of microorganisms.

The study determined the influence of type and amount of herbal supplements on the physical and chemical indicators of milk-vegetable mixture to the combined production of fermented milk products for infant and dietetic foods. The selection of starter cultures for the production of products for children's and dietary nutrition based on Mare's milk was carried out, and the optimal dose of adding plant supplements to the milk mixture in the amount of 10% was established.

Keywords: Mare's milk, starter cultures, fermentation process.

About information authors:

Chomanov Urishbay, Dr. Prof., Academician of NAS RK, department head, Kazakh research institute of processing and food industry, Almaty, Kazakhstan; chomanov_u@mail.ru, <https://orcid.org/0000-0002-5594-8216>

Tultabayeva Tamara, Dr., Academician of AAS RK, laboratory head, Kazakh research institute of processing and food industry, Almaty, Kazakhstan; tamara_tch@list.ru, <https://orcid.org/0000-0003-2483-7406>

Shoman Aruzhan. PhD, leading researcher, Kazakh research institute of processing and food industry, Almaty, Kazakhstan; shoman_aruzhan@mail.ru, <https://orcid.org/0000-0002-7844-8601>

Shoman Assiya, PhD student, senior researcher, Kazakh research institute of processing and food industry, Almaty, Kazakhstan; a.tultabayeva@mail.ru, <https://orcid.org/0000-0003-2415-8112>

Tultabayev Bakhtiyar, engineer, Kazakh research institute of processing and food industry, Almaty, Kazakhstan; baha63@mail.ru, <https://orcid.org/0000-0002-1407-0953>

ЛИТЕРАТУРА

- [1] Смирнова, Е.А. Рынок функциональных молочных продуктов / Е.А. Смирнова, А.А. Кочеткова // Молочная промышленность. 2012. 28 с.
- [2] Канарейкин В.И., Канарейкина С.Г. Кисломолочный продукт из кобыльего молока функциональной направленности // Известия Оренбургского государственного аграрного университета. 2016. No 1 (57). С. 189–192.
- [3] Канарейкин В.И., Канарейкина С.Г. Разработка йогурта из кобыльего молока для работников с вредными условиями труда // Электронный научный журнал. Нефтегазовое дело. 2015. No 6. С. 467–480.
- [4] Канарейкина С.Г. Разработка новых кисломолочных продуктов с растительными компонентами / С.Г. Канарейкина, Е.С. Ганиева, В.И. Канарейкин, И.В. Миронова // Вестник Башкирского государственного аграрного университета. 2015. No 4 (36). С. 43–46.
- [5] Канарейкина С.Г., Канарейкин В.И. Разработка линейки молочно-растительных йогуртов // Известия Оренбургского государственного аграрного университета. 2016. No 1 (57). С. 100–103.
- [6] Приданникова И. А, Елизарова В. В. Закваски прямого внесения и ингредиенты для производства кисломолочных продуктов // Молочная промышленность. 2004. No 2. С. 32–33.
- [7] Тамим А.И., Робинсон Р.К. Йогурты и другие кисломолочные продукты. СПб.: Профессия; 2003. 664 с.
- [8] Пахомов, А.Н. Разработка рецептур и оценка потребительских свойств пищевых продуктов специализированного назначения / А.Н. Пахомов, И.Ю. Пануров, А.А. Щипанова. 2010. 15 с.
- [9] Суржик, А.В. Пробиотики - залог эффективности функциональных продуктов / А.В. Суржик. 2009. 26 с.
- [10] Сорокина, Н.П. Выбор бактериальных заквасок для ферментированной молочной продукции / Н.П. Сорокина, И.В. Кучеренко. 2016. 24 с.
- [11] Старикова, Н.П. Функциональный кисломолочный продукт йогурт, обогащенный биологически активными ингредиентами / Н.П. Стариков. 2013.

REFERENCES

- [1] Smirnova E. A. Market of functional dairy products / E. A. Smirnova, A. A. Kochetkova // Dairy industry. 2012. 28 p.
- [2] Kanarekin V. I., Kanarekina S. G. Fermented milk product from Mare's milk of functional orientation // News of the Orenburg state agrarian University. 2016. No 1 (57). Pp. 189-192.
- [3] Kanarekin V. I., Kanarekina S. G. Development of yogurt from Mare's milk for workers with harmful working conditions // Electronic scientific journal. Oil and gas business. 2015. No 6. Pp. 467-480.
- [4] Kanareikina S. G. the Development of new fermented milk products with vegetable components / Kanareikina S. G., Y. C. Ganiev, V. I. Kanareykin, I. V. Mironova // Bulletin of the Bashkir state agrarian University. 2015. No 4 (36). Pp. 43-46.
- [5] Kanareikina S. G., Kanareikin V. I. Development of a line of milk-vegetable yogurt // News of the Orenburg state agrarian University. 2016. No 1 (57). Pp. 100-103.
- [6] Pridannikova I. A., Elizarova V. V. direct-application starter Cultures and ingredients for the production of fermented milk products // Dairy industry. 2004. No 2. Pp. 32-33.
- [7] Tamim A. Y., Robinson R. K. Yoghurts and other fermented milk products. Saint Petersburg: Profession, 2003, 664 p.
- [8] Pakhomov A. N. Development of recipes and assessment of consumer properties of food products of specialized purpose / A. N. Pakhomov, I. Yu. Panurov, A. A. Shchipanova. 2010. 15 p.
- [9] Surzhik A.V. Probiotics-the key to the effectiveness of functional products / A.V. Surzhik. 2009. 26 p.
- [10] Sorokina N. P. the Choice of bacterial starter cultures for fermented dairy products / N. P. Sorokina, I. V. Kucherenko. 2016. 24 p.
- [11] Starikova N. P. Functional fermented milk product yogurt enriched with biologically active ingredients / N. P. Starikov-2013.

УДК 577.29

Г.Д. Ильгекбаева, Е.Ш. Махашов, Г. Тулепова, Д. Есимханкызы, С.Т. Садиев

Казахский национальный аграрный исследовательский университет, Алматы, Казахстан.
E-mail: sadiev15@mail.ru**ЭКСПРЕССИЯ ПОВЕРХНОСТНОГО АНТИГЕНА *BRUCELLA ABORTUS* OMP16 В РАСТЕНИИ *NICOTIANA BENTHAMIANA***

Аннотация. Бруцеллез – одно из самых заразных и инфекционных заболеваний с высокими показателями заболеваемости крупного рогатого скота и человека в Казахстане. Использование современных биотехнологических методов для разработки надежных и доступных для фермеров вакцин является альтернативой для решения проблемы.

В качестве вектора для получения экспрессии антигенов возбудителя заболевания часто используют вирусы растений. Среди растительных вирусов широко используется вирус А винограда (ВАВ). При разработке вакцин или диагностических тестов против бруцеллеза, мембранные белки бруцеллы являются основными объектами исследований.

Мембранные белки (OMPs) являются специфическими поверхностными антигенами клетки, которые обладают иммуногенностью. OMPs являются идеальными кандидатами для производства рекомбинантных вакцин против бруцеллеза.

Объектом исследования являлся белок наружной мембраны (Omp16), который играет важную роль в подавлении выработки TNF-α в макрофагах. В данном исследовании было проведено молекулярное клонирование и анализ экспрессии гена Omp16, которая использована для экспрессии рекомбинантного белка в растениях. В качестве объектов исследований нами были выбраны бруцеллы из вакцинного штамма *Brucella abortus* 19 и растение *Nicotiana benthamiana*, который широко используется для производства целевого белка и является модельным растением для молекулярно-генетических исследований. Был сконструирован вирусный вектор для экспрессии бруцеллезного антигена Omp16 в растения *Nicotiana benthamiana*. Для регенерации трансгенных растений использовалось 19 экплантов. В результате исследований внесенный ген Omp16 под контроль субгеномного промотора OPC4 успешно экспрессировался с сохранением эффективности экспрессии в трансгенных растениях. Эффективность вирусных векторов оценивалась на уровне транскрипции экспрессии мембранного белка Omp16 и вирусных белков. Инfiltrацию проводили всей листовой пластинки полностью, плотность агробактерий составила 0.7. Были получены трансгенные растения *Nicotiana benthamiana*, несущие ген капсидного белка ВАВ, была достигнута экспрессия мембранного антигена бруцеллы Omp16 в вирусном векторе путем замены OPC4 на ген Omp16. Разработка трансгенных растений была осуществлена с помощью агробактериальной трансформации.

Ключевые слова: *Brucella abortus* 19, мембранные белки, Omp16, экспрессия генов, рекомбинантные белки.

Введение. Бруцеллез – одно из самых заразных и инфекционных заболеваний с высокими показателями заболеваемости крупного рогатого скота и человека в Казахстане. Использование современных биотехнологических методов для разработки надежных и доступных для фермеров вакцин является альтернативой для решения проблемы. Поэтому в последние годы становятся популярными вакцины, разработанные на основе растений, благодаря многим преимуществам, которыми они обладают.

В зависимости от поставленной цели растения модифицируют для получения стабильной или временной экспрессии целевого белка. Хиатт с коллегами в 1989 году, работая над растительной вакциной, доказали, что использование растений для создания субъединичных вакцин является решением проблем, с которыми сталкиваются при производстве традиционных вакцин (1,2). Табак,

картофель, помидоры, кукуруза и рис являются растениями, которые на текущий момент используются в качестве природного «биореактора». Было произведено несколько вакцин на растительной основе, некоторые из которых в настоящее время проходят стадию клинических испытаний.

В качестве вектора для получения экспрессии антигенов возбудителя заболевания часто используют вирусы растений. Среди растительных вирусов широко используется вирус А винограда (ВАВ). Отечественными учеными был разработан вирусный вектор на основе ВАВ, где гетерологичные гены находились под контролем субгеномного промотора открытой рамки считывания 2 (ОРС2), хотя большая экспрессия была получена при встраивании гетерологичных генов под контроль субгеномного промотора ОРС4. К гетерологичным генам относятся ген усиленного флуоресцентного белка и ген капсидного белка вируса хлоротической пятнистости листьев яблони (3). При разработке вакцин или диагностических тестов против бруцеллеза мембранные белки бруцеллы являются основными объектами исследований.

Мембранные белки (OMPs) являются специфическими поверхностными антигенами клетки, которые обладают иммуногенностью. OMPs являются идеальными кандидатами для производства рекомбинантных вакцин против бруцеллеза (4). OMP *Brucella abortus* S99 способствуют синтезу высоких уровней специфических молекул IgG против *Brucella* у кроликов при введении с липополисахаридом (LPS). С помощью моноклональных антител были обнаружены три основных и четыре малых белков наружной мембраны *Brucella abortus* и *Brucella melitensis* (5). Мембранный белок размером 16 кДа, названный Omp16, показывает значительное сходство с пептидогликан-ассоциированными липопотеидами (PAL) многих грамотрицательных бактерий (6). Двухвалентная слитая ДНК-вакцина, кодирующая белок *B. abortus* L7/L12 и белок Omp16, вызывала у мышей линии BALB *in vitro* Th1-доминантный иммунный ответ и значительный уровень защиты от заражения вирулентным штаммом *B. abortus* 544. В этом исследовании прокариотический вектор экспрессии, рЕТ-19b-Omp16, был индуцирован для экспрессии в *E.coli*. Экспрессию рекомбинантных белков можно быстро получить, используя прокариотические системы (7).

Объектом исследования являлся белок наружной мембраны (*Omp16*), который играет важную роль в подавлении выработки TNF- α в макрофагах. В данном исследовании было проведено молекулярное клонирование и анализ экспрессии гена *Omp16*, которая использована для экспрессии рекомбинантного белка в растениях. В качестве объектов исследований нами были выбраны бруцеллы из вакцинного штамма *Brucella abortus* 19, и растение *Nicotiana benthamiana* который широко используется для производства гетерологичного белка и является модельным растением для молекулярно-генетической исследований.

Материалы и методы. Как сообщалось ранее, субклонирование этого гена проводили с использованием вектора рЕТ-19b, и для трансформации клеток был использован штамм TOP10F *Escherichia coli* (*E. coli*). Ген Omp *Omp16* размером 642 п.о. был амплифицирован методом ПЦР и успешно проклонирован. Результаты экспрессии были подтверждены с помощью секвенирования и анализа электрофореза в полиакриламидном геле с додецилсульфатом натрия (SDS-PAGE), который показал правильную полосу белка в 16.5 кДа (8). Клонирование, лигирование, подготовка компетентных клеток и трансформация проведены согласно общепринятым методам молекулярной биологии (9). Для подтверждения нуклеотидной последовательности мы просеквенировали полученный ген Omp16 с помощью анализатора Ion S5 (Thermo Fisher Scientific) в соответствии с протоколом производителя. Секвенирование продукта клонирования подтвердило целостность клонирования.

На следующем этапе ген Omp16, кодирующий поверхностный антиген *Brucella abortus* 19, был проклонирован в векторную плазмиду рGEM3zf+ для последующей сборки с промежуточными конструкциями, необходимыми для получения экспрессии целевого белка в растениях *Nicotiana benthamiana*. Вектор рCASSgva был любезно предоставлен Институтом биологии и биотехнологии растений МОН РК (10). Для клонирования и субклонирования в работе были использованы следующие плазмиды: рGEM3zf+ и рЕТ-19b. Агрофильтрацию растений осуществляли путем использования штамма *EHA105 Agrobacterium tumefaciens*.

Растения *Nicotiana benthamiana* были использованы для получения экспрессии бруцеллезного антигена Omp16 с помощью разработанных вирусных векторов на основе вируса А винограда. Для проведения работ использовались стандартные реактивы и ферменты, предназначенные для генно-инженерных методов (9).

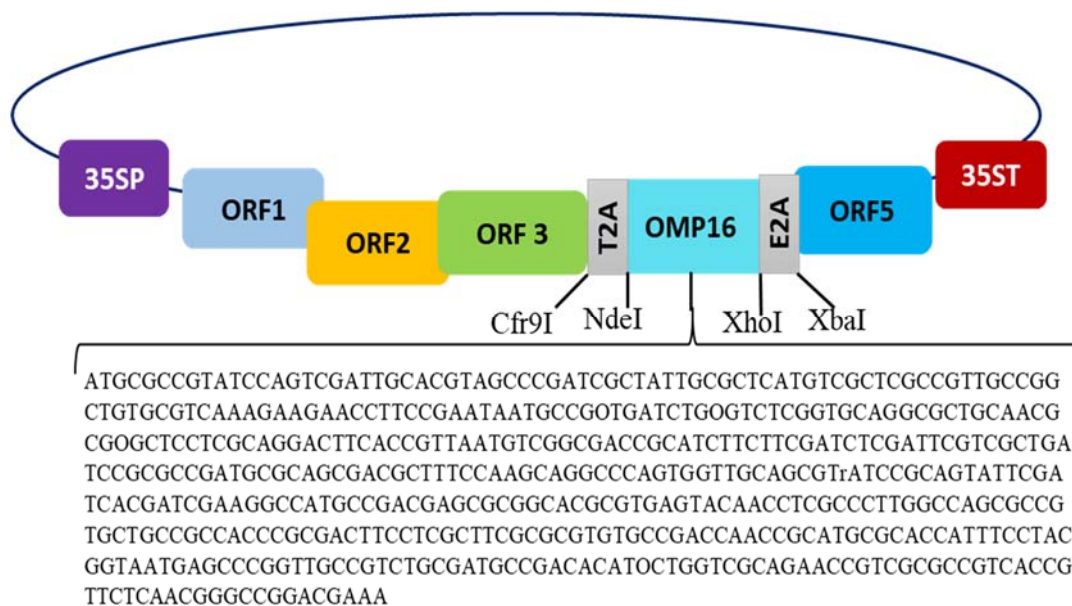

Стратегия конструирования вирусного вектора для экспрессии бруцеллезного антигена Omp16 в растениях *Nicotiana benthamiana*

При трансформации растений с использованием агробактерий семена растений *Nicotiana benthamiana* обрабатывались 10% раствором отбеливателя с добавлением 0,1 % Tween 20 в течение 20 мин. После промывания 10-15 семян располагали в боксы, содержащих твердую MSg среду. Растения из семян выращивали в течение 3-4 недель при 28⁰С и 16- часовом световом периоде. Ежедневно проверялся уровень роста агробактерий. Культивирование эксплантов на среде с антибиотиками осуществлялось в течение 10-20 дней, далее экспланты снова пересаживались на свежую питательную среду и культивировались несколько недель, за это время происходило формирование каллуса. Побеги аккуратно отделялись от каллуса и нижних листков с помощью стерильного скальпеля. 4 побега располагали в один Magenta бокс. Корни начали формироваться через 3-4 недели культивирования. После формирования 3-5 корней длиной 2 см регенеранты готовили для пересадки в почву.

Растения, перенесенные в почву, накрывались пластиковыми колпаками с отверстиями для прохождения воздуха.

Вектор рСАМgva был использован для трансформации агробактерий методом замораживания/оттаивания. Отобранные колонии агробактерий проверялись на наличие конструкций методом ПЦР с соответствующими праймерами.

Анализ экспрессии капсидного белка ВАВ и Omp16 был осуществлен с помощью Вестерн блоттинга. Белки выделялись из тех же листьев, что и РНК. Белки были выделены методом, основанном на использовании мочевины. Кроме того, анализ экспрессии Omp16 в листьях осуществлялся с помощью флуоресцентной конфокальной микроскопии на микроскопе Leica TCS SP8 (Leica MICROSYSTEMS) и с помощью флуоресцентной микроскопии на микроскопе EVOS FL Cell Imaging System (Thermo Fisher Scientific). Статистическая обработка данных проводилась путем высчитывания Байесовского фактора (minBF) в программе Matlab (11).

Обсуждение результатов. В результате исследований был разработан вектор на основе полного генома ВАВ путем внесения гена Omp16 под контроль субгеномного промотора OPC4. Стратегия разработки вектора изображена на рисунке. Гетерологичный ген располагался между OPC4 и OPC5 (12). Стоп-кодона капсидного белка ВАВ и целевого белка были удалены. Экспрессия мембранного белка происходила через 3'-терминальную субгеномную РНК, соответствующую капсидному белку ВАВ в немодифицированном геноме. Разделение мембранного белка и вирусных белков осуществлялось с помощью 2А пептидов, внесенных между капсидным белком ВАВ и мембранным белком. Модифицированная часть генома ВАВ была перенесена в вектор рСАМgva по сайтам AatII и Sall. Анализ на наличие рекомбинантных векторов проводили с помощью ПЦР, использовались праймеры, специфичные для КБ ВХПЛЯ и Omp16.

Эффективность вирусных векторов оценивалась на уровне транскрипции экспрессии мембранного белка Omp16 и вирусных белков. Инfiltrацию проводили полностью всей листовой пластинки, плотность агробактерий составила 0.7. Были получены трансгенные растения *Nicotiana benthamiana*, несущие ген капсидного белка ВАВ, и была достигнута экспрессия мембранного антигена бруцеллы Omp16 в вирусном векторе путем заменой ORC4 на ген Omp16. Разработка трансгенных растений была осуществлена с помощью агробактериальной трансформации. Для регенерации трансгенных растений использовалось 19 эксплантов. Побеги размером 1-2 см в длину пересаживали на среду для формирования корней. После появления 2-3 корней регенерантное растение переносили в почву для адаптации и получения семян. Анализ экспрессии мембранного белка осуществлялся с помощью иммуноблоттинга с использованием первичных антител к целевому белку. Кроме того, экспрессия Omp16 в векторе анализировалась флуоресцентной конфокальной микроскопией на 4-ый день после агроинfiltrации.

В результате исследований внесенный ген Omp16 под контроль субгеномного промотора ORC4 успешно экспрессировался с сохранением эффективности экспрессии в трансгенных растениях. Вирусный вектор можно использовать для экспрессии других бруцеллезных мембранных антигенов, таких как Omp25 или Omp31 в трансгенных растениях, согласно отработанной нами протоколу.

Разработка векторов на основе геномов вирусов для экспрессии мембранных белков бруцеллы является актуальной в виду ряда причин. Во-первых, появилась возможность наработки большого количества бруцеллезных антигенов, необходимых для разработки вакцин и диагностических препаратов. Причем эти антигены, полученные на основе растений, свободные от патогенов животных, обладают дешевой культивирования растений и возможностью быстрого масштабирования производства.

Г.Д. Илгекбаева, Е.Ш. Махашов, Г. Төлепова, Д. Есімханқызы, С.Т. Садиев

Қазақ ұлттық аграрлық зерттеу университеті, Алматы, Қазақстан

**NICOTIANA BENTHAMIANA ЗАУЫТЫНДАҒЫ
БЕТТІК АНТИГЕНДІ BRUCELLA ABORTUS OMP16 БІЛІМІ**

Аннотация. Бруцеллез – Қазақстандағы ірі қара мал мен адам жиі ауыратын жұқпалы және инфекциялық аурудың бірі. Фермерлерге сенімді және қолжетімді вакцина жасау үшін заманауи биотехнологиялық әдістерді қолдану аталған мәселені шешудің баламалы жолы болып саналады.

Өсімдік вирустары көбінесе қоздырғыш антиген экспрессиясын алу үшін вектор ретінде қолданылады. Өсімдік вирусының ішінде жүзім вирусы А (ВАВ) кеңінен пайдаланылады. Бруцеллезге қарсы вакцина немесе диагностикалық мәтін жасауда бруцелланың мембраналық ақуызы зерттеудің негізгі объектісі болып саналады.

Мембраналық ақуыздар (ОМР) – иммуногендік клеткаларға тән беттік антигендер. ОМР – рекомбинантты бруцеллез вакциналарын өндіруге өте қолайлы кандидаттар.

Зерттеу нысанына макрофагтағы TNF- α өндірісін басуда маңызды рөл атқаратын сыртқы мембраналық ақуыз (Omp16) алынды. Бұл зерттеуде молекулалық клондау және өсімдіктердегі рекомбинантты ақуызды экспрессиялау үшін пайдаланылған Omp16 ген экспрессиясына талдау жасалды. Зерттеу нысандары ретінде бруцелланы *Brucella abortus* 19 вакцина штамынан және мақсатты ақуызды өндіруге кеңінен қолданылатын, молекулалық-генетикалық зерттеулердің үлгілі өсімдігі – *Nicotiana benthamiana* өсімдігінен таңдалды. Никотиана бентамиана өсімдігінде бруцеллез Omp16 антигенін экспрессиялау үшін вирустық вектор құрылды. Трансгенді өсімдік регенерациясы үшін 19 эксплант қолданылды. Зерттеу нәтижесінде ORF4 субгеномдық промоторының бақылауы негізінде енгізілген Omp16 гені трансгенді өсімдіктегі экспрессия тиімділігін сақтау арқылы көрінді. Вирустық вектор тиімділігі Omp16 мембраналық протеин мен вирустық белок экспрессиясының транскрипциясы деңгейінде бағаланды. Барлық жапырақ тақтасы инfiltrацияланған, агробактериялардың тығыздығы 0,7. ВАВ капсидті ақуызының генін алып жүретін трансгенді өсімдіктер алынды, ал никотиана бентамиана және вирустық вектордағы бруцеллалардың Omp16 мембраналық антиген экспрессиясына ORF4-ті Omp16 генімен алмастыру арқылы қол жеткізілді. Трансгенді өсімдіктердің дамуы агробактерияларды трансформацияны қолдану арқылы жүзеге асырылды.

Түйін сөздер: *Brucella abortus* 19, мембраналық ақуыздар, Omp16, гендік экспрессия, рекомбинантты белоктар.

G.D. Ilgekbaeva, E.Sh. Makhshov, G. Tulepova, D. Yessimkhankyzy, S.T. Sadiev

Kazakh National Agrarian Research University, Almaty, Kazakhstan

**EXPRESSION OF THE SURFACE ANTIGEN *BRUCELLA ABORTUS* OMR16
IN *NICOTIANA BENTHAMIANA* PLANT**

Abstract. Brucellosis is one of the most contagious and infectious diseases with high incidence rates of cattle and humans in Kazakhstan. Using modern biotechnology techniques to develop vaccines that are reliable and affordable for farmers is an alternative solution to the problem.

Plant viruses are often used as a vector for obtaining the expression of antigens of the pathogen. The grape virus A (BAB) is widely used among plant viruses. *Brucella* membrane proteins are the main objects of this research for further development of vaccines or diagnostic tests against brucellosis,

Membrane proteins (OMPs) are cell specific surface antigens that are immunogenic. OMPs are ideal candidates for the production of recombinant brucellosis vaccines.

The object of the study was the outer membrane protein (Omp16), which plays an important role in the suppression of TNF- α production in macrophages. In this study, molecular cloning and analysis of the expression of the Omp16 gene, which was used to express the recombinant protein in plants, was carried out. We selected brucella from the vaccine strain of *Brucella abortus* 19, and the plant *Nicotiana benthamiana*, as the subjects for our research, since they widely used for the production of recombinant proteins, and they both appropriate for molecular genetic research. A viral vector was constructed to express the brucellosis antigen Omp16 in *Nicotiana benthamiana* plants. Nineteen explants were used for the regeneration of transgenic plants. As a result of this studies, the introduced gene of Omp16 was under the subgenomic promoter control of the ORF4 and was successfully expressed while maintaining the efficiency of expression in transgenic plants. The efficiency of viral vectors was evaluated at the level of transcription during expression of the protein Omp16 with viral proteins. The entire leaf blade was infiltrated; the density of *Agrobacteria* was 0.7. We were able to obtain transgenic plants *Nicotiana benthamiana* carrying the gene of capsid protein BAB, and the expression of the membrane antigen Omp16 in the viral vector was achieved by replacing the ORF4 with the Omp16 gene. The development of transgenic plants was carried out using agrobacterial transformation.

Key words: *Brucella abortus* 19, membrane proteins, Omp16, gene expression, recombinant proteins.

Information about authors:

Ilgekbaeva Gulnaz D., Doctor of Veterinary Sciences, Professor, Department of Biological Safety, Faculty of Veterinary Medicine, KazNAU, Almaty, Kazakhstan; <https://orcid.org/0000-0001-7140-2961>;

Makhshov Edil Sh., candidate of Veterinary Sciences, Acting Professor, Department of Biological Safety, Faculty of Veterinary Medicine, KazNAU, Almaty, Kazakhstan; <https://orcid.org/0000-0003-1922-7144>;

Tulepova Gulmira, doctoral student, Department of Biological Safety, Faculty of Veterinary Medicine, KazNAU, Almaty, Kazakhstan; <https://orcid.org/0000-0002-0681-3788>;

Yessimkhankyzy Dana, master student, Department of Biological Safety, Faculty of Veterinary Medicine, KazNAU, Almaty, Kazakhstan; <https://orcid.org/0000-0001-7035-913X>;

Sadiev Sagypash T., director of the Center for Applied Agricultural Research, KazNAU, Almaty, Kazakhstan; sadiev15@mail.ru; <https://orcid.org/0000-0003-1470-2612>

ЛИТЕРАТУРА

- [1] Saxena J., Rawat S. (2014). “Edible vaccines,” in *Advances in Biotechnology*, pp. 207–226.
- [2] V. Doshi V., H. Rawal H., and Mukherjee S. (2013). “Edible vaccines from GM crops: current status and future scope. *Journal of Pharmaceutical and Scientific Innovation*, vol. 2, no. 3, pp. 1–6.
- [3] Gritsenko D.A., Kenzhebekova R., Deryabina N.D., Galiakparov N.N. (2019). Development of a “deconstructed” vector based on the genome of grapevine virus A. *Plant Biotechnol Rep*. Vol. 13, Issue 2.
- [4] Cassataro J., Velikovsky C.A., De la Barrera S., et al. (2005). *Infect Immun*. 73(10):6537-46.
- [5] Winter A. (1987). Outer membrane proteins of *Brucella*. *Ann Inst. Pasteur/Microbiol*. 1987. 138:87-89.
- [6] Tibor A., Weynants V., Denoel P., et al. (1994). Molecular cloning, nucleotide sequence, and occurrence of a 16.5-kilodalton outer membrane protein of *Brucella abortus* with similarity to PAL lipoproteins. *Infect Immun*. 62:3633–3639.
- [7] Ермилова, Е.В. (2012). Молекулярные аспекты адаптации прокариот: монография/Е.В. Ермилова. 2-е изд., Санкт-Петербург: Химиздат, 342 с.
- [8] Ильгекбаева Г.Д., Махашов Е.Ш., Тулепова Г., Садиев С.Т. (2019). Клонирование и экспрессия белка наружной мембраны бруцеллы Omp16. Исследования, результаты. № 3 (83) ISSN 2304-3334.
- [9] Ausubel F.M., Brent R., Kingston R.E. et al. (1999) *Short Protocols in Molecular Biology*, 4th edn., New York: Wiley.
- [10] Galiakparov N., Tanne E., Sela I., Gafny R. (2003). Functional analysis of the grapevine virus A genome//*Virology*. 003. V. 306. P.42-50.
- [11] Lewandowski, D.J., Dawson, W.O. (1998). Deletion of internal sequences results in tobacco mosaic virus defective RNAs that accumulate to high levels without interfering with replication of the helper virus//*Virology*. Vol. 251.P. 427-437.
- [12] Rubinson E., Galiakparov N., Radian S., et al. (1997). Serological detection of grapevine virus A using antiserum to a nonstructural protein, the putative movement protein//*Phytopathology*, Vol. 87. P. 1041-1045.

REPORTS OF THE NATIONAL ACADEMY OF SCIENCES
OF THE REPUBLIC OF KAZAKHSTAN

ISSN 2224-5227

<https://doi.org/10.32014/2020.2518-1483.123>

Volume 5, Number 333 (2020), 86 – 93

УДК 616

МРНТИ 76.00.00

**V.V. Benberin, T.A. Voshchenkova, A.A. Nagymtayeva,
A.S. Sibagatova, K.M. Akhmetova, A.N. Makhmutova**

Medical Center Hospital of the President's Affairs Administration
of the Republic of Kazakhstan, Nur-Sultan, Kazakhstan.

E-mail: Benberin@bmc.mcupd.kz, Vochshenkova@bmc.mcupd.kz, Nagimtayeva@bmc.mcupd.kz,
Sibagatova@bmc.mcupd.kz, AkhmetovaKM@bmc.mcupd.kz, Makhmutova@bmc.mcupd.kz

INFLUENCE ON HOMEOSTASIS AS THE CRITERION FOR SELECTING SINGLE NUCLEOTIDE POLYMORPHISMS FOR THE STUDY OF METABOLIC SYNDROM IN THE KAZAKH POPULATION

Abstract. Metabolic syndrome (MS) is increasingly cited as the world's leading health risk. The sequence of events toward multimorbidity in most cases passes through MS. According to the research, MS heritability ranges from 23 to 27% in Europeans, and 51 to 60% in Asians.

The purpose of the review: to form a strategy for the selection of single nucleotide polymorphisms (SNPs) for the study of MS in the Kazakh population based on the effect of SNPs on homeostasis indicators

The stable symptom complex of MS is a complicated dynamic system of successive accumulations of dysmetabolic disorders of homeostasis. This system starts the development of subsequent age-associated diseases), such as cardiometabolic, neurodegenerative, and malignant neoplasms.

The system for selecting SNPs for the MS study, proposed on the basis of the concept of homeostasis dysfunction, assumes, in conditions of limited resources, to see the greatest level of their influence within the conditional framework of three genetic models of homeostasis dysregulation: insulin resistance, oxidative stress, and chronic inflammation. This approach is fundamentally different from the traditional approach involving candidate genes. It is expected that scientific research in this direction will contribute not only to the understanding of general biological processes, but also to the targeted search for genetic determinants and for new opportunities for personalized interventions.

Key words: Metabolic syndrome, single nucleotide polymorphisms, homeostasis.

Introduction. MS is increasingly cited as the world's leading health risk. It combines a group of features including IR, excess fat deposit, and high blood pressure. These signs, with the accumulation of violations of physiological control (homeostasis) in the human body, contribute to the premature onset of AAD. Homeostasis disorders in MS are predominantly associated with IR, OS and CHI [1]. Multimorbidity indicates the irreversibility of homeostasis disorders[2].

To develop a management technology for MS means to solve the problem of shifting the onset of a number of significant diseases associated with age to a later age period. It is assumed that the MS pathogenesis is based on the interaction between genetic, environmental and lifestyle factors. Probably, for this reason, studies of genetic associations in MS are extremely confused, and the genetic structure has not yet concrete confirmation of its specificity and significance.

Future studies of the hereditary nature of MS may be more fruitful if we focus on the analysis of the interactions of genetic determinants. It is already obvious that the risk of AAD is influenced not by loci with the main phenotypic influence, but by multiple variants of a weak effect. Interacting, they give a unique complex effect of such a multifactorial state as MS, which precedes most AAD.

MS arises as a result of the sequential accumulation of dysmetabolic disorders of the homeostasis with a relatively strong contribution of genetic factors. According to some studies, the heritability of MS ranges from 23 to 27% in Europeans, and from 51 to 60% in Asians [3].

The general scheme of the formation of a stable symptom complex of MS and subsequent AAD is as follows.

Food overload results in hyperinsulinemia and hyperlipidemia. Against this, the regulating receptors of homeostasis contribute to the compensatory shutdown of insulin dependence. At the muscle level, their insulin sensitivity and glucose utilization decrease, at the adipocyte level, their insulin sensitivity and glucose uptake decrease, and the process of fat accumulation (abdominal obesity (AO)) is triggered.

Prolonged compensatory disconnection of insulin dependence, fixing itself at the transcriptional level, leads to a restructuring of the entire metabolism and the formation of IR, which maintains constant activation of stress-dependent kinases, OS and ChI in adipocytes. As a consequence, a violation of the endothelial barrier develops with the formation of endothelial dysfunction and the development of AH to already declared obesity and IR as prediabetes [4].

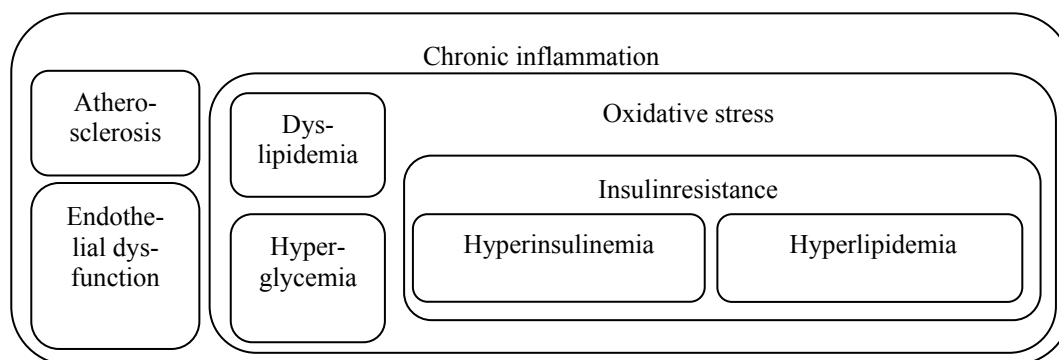

Figure 1 - The relationship between homeostasis disorders in MS

It is obvious that the pathogenesis of MS is much more complex and is accompanied by numerous effects of known and still unknown molecules and signaling pathways [5]. Future studies of the hereditary nature of MS may be more fruitful if we focus on the analysis of the interactions of genetic determinants. It is already obvious that the risk of AAD is influenced not by loci with the main phenotypic influence, but by multiple variants of a weak effects. Interacting, they give a unique complex effect of such a multifactorial state as MS, which precedes most AAD.

Methods. The purpose of the selection of SNPs was the need to obtain a list of SNPs, presumably significant for MS and the early realization of associated diseases in persons of the Kazakh ethnic group in the third generation. In this case, it is necessary to provide for the conditions for the future research:

- financial compliance: financial stability of the study in conditions of limited financial resources, which do not allow conducting a classical study in accordance with the requirements of GWAS;
- technological compliance: competitiveness of results in the research market;
- scientific relevance: scientific novelty of the research, which consists in testing the scientific hypothesis for the Kazakh population;
- compliance with the needs of practical health care: a scientific idea for an inexpensive and effective technology of preclinical diagnosis of AAD in MS for the Kazakh population.

There are many converging biological processes underlying the unique stability of homeostasis, in which more than one million already identified or not yet identified SNPs can participate. In this regard, the selection of the SNP was carried out sequentially in 3 stages.

At the first stage, candidates were selected for research from the Catalog compiled on the basis of GWAS of the National Human Genome Research Institute. Sample condition: association of SNP with AAD and signs of MS in the complex: type 2 diabetes mellitus / insulin sensitivity, function and

proliferation of beta cells of the pancreas, blood sugar level; AO / improper lipolysis; arterial hypertension / membrane traffic, vascular wall dysfunction, systolic pressure; MN / protein aggregation, control of molecular damage, proliferation, lysosomal autophagy; NDD / nerve cell differentiation, immune inflammation. A total of 1,220 SNP candidates were selected for the study.

The study of subsequent studies (related publications containing links to basic publications) allowed us to deepen our understanding of the participation of individual SNPs in the homeostasis of the human body. We used the resources of the US National Library of Medicine, which indexes over 23 million biomedical publications. At the second stage of selection, the number of SNP candidates for the study decreased from 1220 to 240, which could be conditionally associated with the causal consequences of homeostasis disturbance for MS: IR, OS, ChI. At the 3rd stage of selection, we carried out the final selection of SNPs that have an effect on the largest number of homeostasis links.

Thus, the non-random selection of SNPs associated with AAD and their subsequent distribution between the main interrelated phenotypes of MS made it possible to determine from the opposite 114 SNPs, suggesting a genetic influence on the early, at working age, development of AAD in the Kazakh population.

Results. A list of 128 SNPs was obtained, on the one hand, has an effect on several links of homeostasis involved in the implementation of MS, on the other hand, it has a direct relationship with AAD, realized at the age of up to 60 years in individuals of other populations. Moreover, each of the SNPs has an impact on several links in the pathogenesis of MS, while maintaining the priority value of one of them (figure 2).

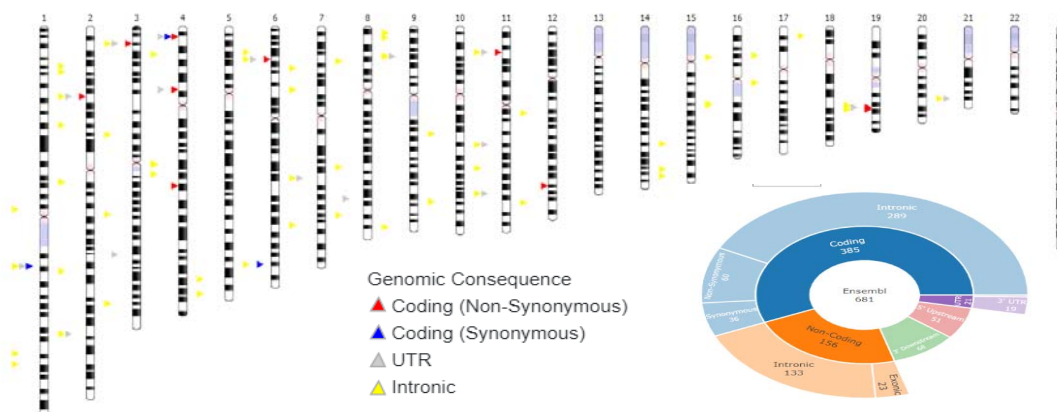

Figure 2 - Graphical representation of the panel of genetic polymorphisms (n = 128)

The pathway to target disruption of homeostasis to see some systemic damage to molecular pathways limited the number of SNPs occupying exon positions (19 of 128).

Discussion. MS is a genetically complex disorder where traditional genetic analytics are unable to explain its entire symptom complex. Known genes can explain only part of the expected heritability. The identification of associations by linkage analysis is very difficult, since the genetic risk can spread throughout the genome, and not be concentrated in one locus. The results of SNP selection suggest that multiple loci in AAD may be associated with specific MS phenotypes, which gives hope for the development of future therapeutic approaches targeting the involved genetic pathways, taking into account the principle of «common disease-common approaches» [5,6]. The SNPs selected for the study are conditionally divided into 3 phenotype / genotypic models, which, from our point of view, have for the development of MS and subsequent AADs.

Loss of glycemic control has a strong relationship with lipid metabolism; identification of genetic variants of IR would allow choosing the right path in the search for potential therapeutic targets [7]. Table 3 shows SNPs that have shown themselves to have a predominant effect on the maintenance of IR.

Table 1 - SNPs that have a predominant effect on maintaining IR

The reference sequence	Functionality class	OR (95% CI) / Beta
rs5945326	Regulatory region	1.27 [1.18-1.37]
rs340874	Exon	NR
rs7578597	Exon	1.15 [1.10-1.20]
rs243021	Intron	1.08 [1.06-1.10]
rs7593730	Intron	1.11 [1.08-1.16]
rs6543087	Intron	1.11 [1.08-1.13]
rs7578326	Regulatory region	1.11 [1.08-1.13]
rs4402960	Intron	1,14 (1,08-1,21)
rs4607103	Intron	1.09 [1.06-1.12]
rs11708067	Intron	1.09 [1.08-1.11]
rs1801214	Exon	1.13 [1.08-1.18]

The reference sequence	Functionality class	OR (95% CI) / Beta
rs7756992	Intron 5	1.15 [1.13-1.17]
rs972283	Intergenic	1.07 [1.05-1.10]
rs3802177	UTR	1.15 [1.10-1.21]
rs896854	Intron	1.06 [1.04-1.09]
rs1575972	Intergenic	1.1 [1.06-1.14]
rs7041847	Intron	1.05 [1.01-1.09]
rs4506565	Intron	1,36 (1,20-1,54)
rs7903146	Intron	1.37 [1.31-1.43]
rs10830963	Intron	1.1 [1.09-1.12]
rs5219	Nonsense	1.19 [1.11-1.27]

OS is associated with abnormal redox status predominantly due to altered redox signaling [8]. Table 2 shows SNPs that showed their negative impact on its maintenance.

Table 2 - SNPs with a primary effect on OS maintenance

The reference sequence	Functionality class	OR (95% CI) / Beta
rs3814316	Exon	NR
rs4072037	Splicing	NR
rs7554672	Intergenic	1.21[NR]
rs10923931	Intron	1.13 [1.08-1.17]
rs13016963	Intron	1.27[1.09-1.19]
rs1035142	UTR	0.64[0.09–0.03]
rs62106670	Intron	1.05[1.04-1.07]
rs59308963	Intron	1.05[1.03-1.07]
rs1470579	Intron	1.17[1.11-1.23]
rs1801282	Exon	1.14[1.08-1.20]
rs1648707	Intergenic	0.94 [NR]
rs76551843	Intron	1.31[1.19–1.44]
rs4976790	Intron	1.08[1.05–1.10]
rs1799945	Exon	0.6270 [NR]
rs1562430	Intron	1.17[1.10-1.25]
rs6988985	Intergenic	0.46[0.15-0.35]
rs28834970	Intron	1.10[1.08-1.13]
rs72652411	Intron	NR
rs62560775	Intron	1.11[1.06–1.15]
rs1011970	Intron	1.07[1.04-1.09]
rs564398	UTR	1.13 [1.08-1.19]
rs17490626	Intron	1.16[1.09-1.24]
rs7957197	Intron	1.07[1.05-1.10]
rs1121980	Intron	1.66[1.37-2.01]
rs9939609	Intron	0.36 [NR]
rs17817449	Intron	NR

The reference sequence	Functionality class	OR (95% CI) / Beta
rs12149832	Intron	0.08[0.07-0.09]
rs11075995	Intron	1.11[1.07-1.15]
rs12601991	Intron	NR
rs4430796	Intron	1.22[1.15-1.30]
rs11868035	Splicing	1.19[1.07-1.33]
rs403814	Intron	1.15[1.07-1.23]
rs11672691	Exon	1.11[1.02-1.20]
rs887391	Intron	1.31[1.17-1.46]
rs25487	Exon	1.24[1.01-1.51]
rs1799782	Exon	0.41[0.08-2.08]
rs4962416	Intron	1.17 [1.05-1.30]
rs17021918	Intron	1.09 [1.07-1.11]
rs2121875	Intron	1.05 [1.03-1.07]
rs12543663	Intron	1.04 [0.72-1.49]
rs6983561	Intron	1.61 [1.45-1.78]
rs16901979	Intergenic	1.42 [NR]
rs16902094	Intron	1.21 [1.25-1.26]
rs2075650	Intron	2.53[2.37-2.71]
rs55886062	Intron	1.1 [1.08-1.12]
rs4973768	UTR	1.38 [NR]
rs121434592	Intron	1.47[1.19-1.41]
rs11571747	Intron	1.72[1.09-1.13]
rs11571746	Intron	1.69[1.09-1.33]
rs13389423	Intron	1.68[1.49-1.9]
rs3218695	Intron	NR
rs2227924	Intron	NR

ChI is also accompanied by neuroinflammation and subsequent neurodegeneration [9]. Table 3 provides a list of SNPs that suggest a predominant negative effect on ChI maintenance.

Table 3 - SNPs with a predominant impact on ChI maintenance

The reference sequence	Functionality class	OR (95% CI)/ Beta	The reference sequence	Functionality class	OR (95% CI) / Beta
rs1856746	Intron	2.96 [1.89-4.64]	rs675026	Exon	0.72 [1.11-1.3]
rs2791713	Intergenic	3.00 [1.90, 4.73]	rs6978712	Intergenic	2.02 [1.53-2.68]
rs1003376	Intron	3.00 [0.04-036]	rs7801190	Exon	1.31 [1.19-1.44]
rs2236935	Intron	NR	rs3800688	Intron	1.197
rs2236936	Intron	NR	rs2191349	Intergenic	NR
rs11674694	Intron	NR	rs864745	Intron	1.1 [1.07-1.13]
rs897876	Intron	1.036 [NR]	rs11781551	Intergenic	0.0078
rs113296370	Intergenic	8.83 [8.01-9.65]	rs11787792	Intron	1.15 [1.10-1.20]
rs4665630	Intron	1.21 [1.13-1.3]	rs17584499	Intron	1.57 [1.36-1.82]
rs11124945	Intron	NR	rs1110183	Intron	NR
rs780094	Intron	0.71 (0.58–0.85)	rs1552224	UTR	1.14[1.11-1.17]
rs5186	UTR	7.3 [1.9-31.9]	rs1387153	Intergenic	1.09[1.06-1.11]
rs11931074	Intron	1.37 [1.27-1.48]	rs2292239	Intron	1.28[1.21-1.35]
rs356219	Intron	1.29 [1.25-1.33]	rs3184504	Exon	0.4480[NR]
rs181489	Intron	NR	rs1550576	Intergenic	1.92[NR]
rs2737029	Intron	1.38 [1.20-1.59]	rs2398162	Exon	1.31[1.03-1.67]
rs11724635	Intron	1.15 [1.11-1.19]	rs2241423	Intron	0.13 [0.09-0.17]
rs2736990	Intron	1.29 [1.18-1.43]	rs11646213	Intergenic	1.28[1.15-1.43]
rs13107325	Exon	0.19 [0.11-0.27]	rs13333226	Intron	1.15[1.10-1.19]
rs10026364	Intergenic	1.28 [1.15-1.42]	rs1108775	Intergenic	1.00[0.72, 1.39]
rs1834481	Intergenic	NR	rs7412	Exon	3.0[2.82-3.64]
rs10021303	Intron	NR	rs429358	Exon	6.0[1.56-1.80]
rs35529250	Exon	NR	rs157582	Intron	0.1[NR]
rs991316	Intergenic	1.62 [NR]	rs1735151	Exon	1.16[1.09-1.24]
rs6842241	Intergenic	1.18 [1.11-1.25]	rs2822693	Intergenic	2.22[1.32-2.04]
rs6596140	Intergenic	NR	rs1475591	Intergenic	1.18[1.10-1.27]
rs1173771	Intergenic	0.2610 [NR]			

Studies of SNPs in terms of their maintenance of dysregulation of homeostasis make it possible to consider MS as a complex dynamic system. Connections along the causal chain from DNA variant to trait variation can be extremely complex. Revealing the functional impact of regulatory variations will still require careful experimental work [10]. Only a combination of genome-wide studies of genetic variation, detailed phenotypic and omic data on millions of people can become a source for new fundamental discoveries. A large sample size is critical for identifying significant SNPs, especially their more elusive trans-acting variants.

However, new scientific ideas that take into account different physiological conditions, worked out in detail in small cohorts united by a single ethnicity, may also provide directions for future research in the field of MS genetics [11]. In this regard, a systemic sample of SNPs focused on the main pathogenetic mechanisms of MS leading to chronic destabilization of homeostasis, and their subsequent assessment can become the basis for initiating such ideas.

Conclusions. The sequence of events in a person's life on the way to multimorbidity in most cases runs through MS. It is the optimal time for interventions that can affect reversible homeostasis disorders. The system for selecting SNPs for MS studies, proposed on the basis of the concept of maintaining homeostasis dysfunction, assumes, in conditions of limited resources, to see the greatest level of their influence on the phenotype.

This approach not only promotes understanding of general biological processes, but also provides a targeted search for genetic determinants for scientific research, as well as new opportunities for personalized interventions.

**В.В. Бенберин, Т.А.Вощенкова, А.А. Нағымтаева,
А.С. Сибағатова, К.М. Ахметова, А.Н. Махмутова**

Қазақстан Республикасы Президенті Іс басқармасы
Медициналық орталығының ауруханасы, Нұр-Сұлтан, Қазақстан

ГОМЕОСТАЗҒА ӘСЕР ЕТУ – ҚАЗАҚ ПОПУЛЯЦИЯСЫНДАҒЫ МЕТАБОЛИЗМ СИНДРОМЫН ЗЕРТТЕУ ҮШІН БІРНУКЛЕОТИДТІ ПОЛИМОРФИЗМДЕРДІ ІРІКТЕУДІҢ ӨЛШЕМ-ШАРТТАРЫ

Аннотация. Метаболизм синдромын (МС) әдетте әлемде денсаулықтың негізгі қаупі деп атайды. Мультиморбидтілік жолындағы оқиғалардың реттілігі көп жағдайда МС арқылы өтеді. Зерттеулерге сәйкес, МС тұқым қуалаушылығы еуропалықтарда 23-тен 27%-ке дейін, ал азиаттарда 51-ден 60%-ке дейін кездеседі.

Шолудың мақсаты – үшінші буындағы қазақ этносының өкілдерінде МС және сонымен ассоциацияланған (байланысты) ауруларды дер кезінде анықтау үшін болжамды маңызы бар бірнуклеотидті полиморфизмдер (БНП) тізбесін қалыптастыру. Бұл ретте зерттеу үшін келесі шарттарды қарастыру қажет: қаржылық сәйкестік (шектеулі ресурстар жағдайындағы қаржылық тұрақтылық); технологиялық сәйкестік (ғылыми зерттеулер нарығындағы нәтижелердің бәсекеге қабілеттілігі); ғылыми сәйкестік (өзінің ғылыми гипотезасын тексеруден тұратын ғылыми жаңалық); практикалық денсаулық сақтау қажеттіліктеріне сәйкестік (қазақ популяциясындағы МС жанындағы ЖАА (жас ассоциацияланған (жаспен байланысты) аурулар) клиникаға дейінгі диагностикасының арзан және тиімді технологиясы үшін ғылыми идея).

МС тұрақты симптом кешені – гомеостаздың дисметаболизмдік бұзылыстарының дәйекті жинақталуының күрделі динамикалық жүйесі. Аталған жүйе кейіннен жас-ассоциацияланған кардиометаболизмдік (КМА), нейродегенеративті (НДА), сондай-ақ қатерлі ісіктер (ҚІ) сияқты аурулардың басталуына алып келеді. МС – гомеостаздың қайтымды бұзылысына әсер етуі ықтимал араласудың оңтайлы уақыты. МС басқару технологиясын жасау дегеніміз – жасқа байланысты бірқатар маңызды аурулардың пайда болғаннан кейінгі жас кезеңіне ауысу мәселесін шешу деген сөз.

Гомеостаздың бірегей тұрақтылығы негізінде жатқан көптеген тоғысатын биологиялық процестер бар, онда қазірдің өзінде сәйкестендірілген немесе сәйкестендірілмеген бір миллион емес, одан да көп БНП қатыса алады. Осыған байланысты БНП іріктеу 3 кезеңде жүйелі түрде жүргізілді.

Бірінші кезеңде адам геномын зерттеу ұлттық институтының қауымдастықтарын (GWAS) толық геномдық іздеу негізінде құрылған каталогтан зерттеу үшін СНП-кандидаттар іріктелді. Іріктеу шарты: БНП-ның ЖАА-мен және МС белгілерімен бірге келесі жиынтықтағы ассоциациялануы: ҚД2/ инсулинге сезімталдық, ұйқыбездің бета жасушаларының қызметі мен көбеюі, қандағы кант деңгейі; АС (абдоминалды семіздік/ дұрыс емес липолиз; АГ (артериялық гипертензия) / мембраналық трафик, тамыр қабырғасының дисфункциясы, систоалық қысым деңгейі; ҚІ (қатерлі ісік) / белоктардың агрегациясы, молекулалық зақымдануды бақылау, пролиферация (көбею), лизосомалық аутофагия; НДА (нейродегенеративті аурулар) / жүйке жасушаларының дифференциациясы, иммундық қабыну. Барлығы 1 220 БНП-кандидат зерттеу үшін іріктелді. Кейінгі зерттеулерді зерделеу (негізгі жарияланымдарға сілтемелері бар байланысты жарияланымдар) жеке БНП-ның адам организмінің гомеостазына қатысуы туралы түсінігімізді тереңдетуге мүмкіндік берді. 23 миллионнан астам биомедициналық басылымдарды индекстейтін АҚШ Ұлттық медициналық кітапханасының ресурстары пайдаланылды. Іріктеудің екінші кезеңінде зерттеуге СНП-кандидаттар саны 1220-дан 240-қа дейін қысқарды, оларды МС үшін гомеостаздың бұзылуының себептік салдарымен шартты түрде байланыстыруға болады: инсулинге төзімділік (ИТ), тотығу стресі (ТС), созылмалы қабыну (СК). Іріктеудің үшінші кезеңінде біз гомеостаз байланыстарының ең көп санына әсер ететін БНП-ны соңғы іріктеуді жүзеге асырдық.

Осылайша МС және ЖАА-мен байланысты БНП-ны кездейсоқ таңдау, олардың кейіннен МС-тың негізгі өзара байланысты фенотиптері арасында бөлінуі қазақ популяциясында ЖАА-ның дамуына ерте, еңбекке қабілетті жаста генетикалық әсер ететінін болжамдайтын 128 БНП-ны кері анықтауға мүмкіндік берді. Гомеостаз дисфункциясы тұжырымдамасы негізінде ұсынылған МС зерттеуіне арналған БНП іріктеу жүйесі шектеулі ресурстар жағдайында гомеостазды дисрегуляциялаудың 3 фенотипі/генотиптік модельдерінде олардың әсерінің ең жоғары деңгейін көруге мүмкіндік береді: ИТ, ТС және СҚ. Бұл тәсіл кандидат гендердің қатысуы негізінде дәстүрлі тәсілден түбегейлі ерекшеленеді. Реттеуші вариациялардың функционалды әсерін анықтау әлі де мұқият эксперименттік жұмысты қажет етеді. Тек генетикалық вариациялардың толық геномдық зерттеулерінің, миллиондаған адамдар туралы егжей-тегжейлі фенотиптік және омникалық мәліметтердің үйлесімі жаңа іргелі ашылулардың қайнар көзі бола алады. Іріктеудің үлкен көлемі маңызды БНП-ны, әсіресе олардың транс-қолданыстағы нұсқаларын анықтау үшін өте маңызды. Десек те, түрлі физиологиялық жағдайларды ескеретін жаңа ғылыми идеялар, біртұтас этникалық топтармен біріктірілген шағын когорттарда егжей-тегжейлі зерттеліп, МС генетикасы саласындағы болашақ

зерттеулерге бағыт бере алады. Осыған байланысты гомеостаздың созылмалы тұрақсыздануына әкелетін МС-тың негізгі патогенетикалық механизмдеріне бағытталған БНП-ны жүйелі іріктеу және оларды кейінгі бағалау осындай идеяларды бастауға негіз бола алады. Бұл бағыттағы ғылыми ізденіс жалпы биологиялық процестерді түсінуге ғана емес, сонымен бірге ғылыми зерттеулер үшін генетикалық детерминанттарды мақсатты іздеуге, сондай-ақ жеке араласудың жаңа мүмкіндіктеріне ықпал етеді деп күтілуде.

Шолу «Қазақстан Республикасы Білім және ғылым министрлігінің Ғылым комитеті» ММ тапсырысы бойынша BR05236375 «Қазақ популяциясындағы метаболизмдік синдроммен ассоциацияланған аурулардың генетикалық қаупінің ерекшеліктерін зерттеу» ғылыми-техникалық бағдарламасы шеңберінде жасалды. Ұсынылған тәсілдің дұрыстығы бағдарламаның эксперименттік бөлігі аяқталғаннан кейін түсінікті болады.

Түйін сөздер: метаболизм синдромы, бірнуклеотидті полиморфизм, гомеостаз.

**В.В. Бенберин, Т.А. Вощенкова, А.А. Нагимтаева,
А.С. Сибагатова, К.М. Ахметова, А.Н. Махмутова**

Medical Center Hospital of the President's Affairs Administration
of the Republic of Kazakhstan, Nur-Sultan, Kazakhstan

ВЛИЯНИЕ НА ГОМЕОСТАЗ – КРИТЕРИЙ ОТБОРА ОДНОНУКЛЕОТИДНЫХ ПОЛИМОРФИЗМОВ ДЛЯ ИССЛЕДОВАНИЯ МЕТАБОЛИЧЕСКОГО СИНДРОМА В КАЗАХСКОЙ ПОПУЛЯЦИИ

Аннотация. Метаболический синдром (МС) все чаще называют основным риском для здоровья в мире. Последовательность событий на пути к мультиморбидности в большинстве случаев проходит через МС. Согласно исследованиям, наследуемость МС составляет от 23 до 27% у европейцев, и от 51 до 60% – у азиатов.

Цель обзора: сформировать перечень однонуклеотидных полиморфизмов (ОНП), предположительно значимых для ранней реализации МС и ассоциированных с ним заболеваний у лиц казахского этноса в третьем поколении. При этом необходимо предусмотреть следующие условия последующего исследования: финансовое соответствие (финансовая устойчивость в условиях ограниченных ресурсов); технологическое соответствие (конкурентоспособность результатов на рынке научных исследований); научное соответствие (научная новизна, заключающаяся в проверке собственной научной гипотезы); соответствие потребностям практического здравоохранения (научная идея для недорогой и эффективной технологии доклинической диагностики ВАЗ при МС в казахской популяции).

Устойчивый симптомокомплекс МС представляет собой сложную динамическую систему последовательных накоплений дисметаболических нарушений гомеостаза. Эта система дает начало последующим возраст-ассоциированным заболеваниям (ВАЗ), таким как кардиометаболические (КМЗ), нейродегенеративные (НДЗ), а также злокачественным новообразованиям (ЗНО). МС является оптимальным временем для вмешательств, способных влиять на обратимые нарушения гомеостаза. Разработать технологию управления МС – значит, решить проблему сдвига наступления ряда значимых заболеваний, ассоциированных с возрастом, на более поздний возрастной период.

Существует множество сходящихся биологических процессов, лежащих в основе уникальной устойчивости гомеостаза, в которых может участвовать не один миллион уже идентифицированных или пока не идентифицированных ОНП. В этой связи отбор ОНП был проведен последовательно в 3 этапа.

На первом этапе был проведен отбор СНП-кандидатов для исследования из Каталога, составленного на основе полногеномных поисков ассоциаций (GWAS) Национального института исследования генома человека. Условие для выборки: ассоциация ОНП с ВАЗ и признаками МС в комплексе: СД2/чувствительность к инсулину, функция и пролиферация бета-клеток поджелудочной железы, уровень сахара в крови; АО/неправильный липолиз; АГ/мембранный трафик, дисфункция сосудистой стенки, уровень систолического давления; ЗНО/агрегация белков, контроль молекулярных повреждений, пролиферация, лизосомная аутофагия; НДЗ/ дифференцировка нервных клеток, иммунное воспаление. Всего было выбрано 1 220 ОНП-кандидатов для исследования. Изучение последующих исследований (связанные публикации, содержащие ссылки на базовые публикации) позволило нам углубить понимание участия отдельных ОНП в гомеостазе человеческого организма. Были использованы ресурсы Национальной медицинской библиотеки США, индексирующей более 23 млн биомедицинских публикаций. На втором этапе отбора число ОНП-кандидатов для исследования сократилось с 1220 до 240, которые можно было условно связать с причинными для МС последствиями нарушения гомеостаза: инсулинорезистентность (ИР), окислительный стресс (ОС), хроническое воспаление (ХВ). На 3 этапе отбора мы осуществили завершающий отбор ОНП, имеющих эффект на наибольшее число звеньев гомеостаза.

Таким образом, неслучайный выбор ОНП, связанных с МС и ВАЗ, их последующее распределение между основными взаимосвязанными фенотипами МС позволило от обратного определить 128 ОНП, предполагающих генетическое влияние на раннее, в трудоспособном возрасте, развитие ВАЗ в казахской популяции. Предлагаемая на основе концепции дисфункции гомеостаза система отбора ОНП для исследования МС предполагает в условиях ограниченных ресурсов увидеть наибольший уровень их влияния в условных рамках 3 фенотип/генотипических моделей дисрегуляции гомеостаза: ИР, ОС и ХВ. Такой подход принципиально отличен от традиционного подхода с участием генов-кандидатов. Выявление функционального воздействия регуляторных вариаций по-прежнему будут требовать тщательной экспериментальной работы. Только комбинация полногеномных исследований генетических вариаций, подробных фенотипических и омнических данных о миллионах людей способны стать источником для новых фундаментальных открытий. Большой объем выборки имеет решающее значение для определения значимых ОНП, особенно более неуловимых их трансдействующих вариантов. Тем не менее, новые научные идеи, учитывающие различные физиологические условия, детально отработанные на небольших когортах, объединенных единой этнической принадлежностью, также могут дать направления для будущих исследований в области генетики МС. В этой связи системная выборка ОНП, ориентированная на основные патогенетические механизмы МС, ведущие к хронической дестабилизации гомеостаза, и их последующая оценка могут стать основой для инициации таких идей. Ожидается, что научный поиск в этом направлении будет способствовать не только пониманию общих биологических процессов, но и целенаправленному поиску генетических детерминант для научных исследований, а также новым возможностям для персонализированных вмешательств.

Обзор выполнен в рамках научно-технической программы BR05236375 «Исследование особенностей генетического риска заболеваний, ассоциированных с метаболическим синдромом в казахской популяции, по заказу ГУ «Комитет науки Министерства образования и науки Республики Казахстан». Правильность представленного подхода будет понятна после завершения экспериментальной части программы.

Ключевые слова: синдром метаболизма, один нуклеотидный полиморфизм, гомеостаз.

Information about authors:

Benberin V.V., Academician of NAS RK, Doctor of Medical Sciences, Professor; <https://orcid.org/0000-0002-7286-1593>;

Voshchenkova T.A., Master of Business Administration; <https://orcid.org/0000-0003-0935-6217>;

Nagimtayeva A.A., Candidate of Medical Sciences, <https://orcid.org/0000-0002-9139-7431>;

Sibagatova A.S., Master in Health Care Management, <https://orcid.org/0000-0001-6399-3810>;

Akhmetova K.M., Master in Preventive Medicine, <https://orcid.org/0000-0001-7500-4813>;

Makhmutova A.N., Candidate of Chemical Sciences, Associate Professor of Chemistry, <https://orcid.org/0000-0003-0618-8545>

REFERENCES

[1] Veen LV, Morra J, Palanica A, Fossat Y. Homeostasis as a proportional-integral control system. NPJ Digit Med. 2020;3:77. Published 2020 May 22. doi:10.1038/s41746-020-0283-x

[2] Simmons, R.K., Alberti, K.G.M.M., Gale, E.A.M. et al. The metabolic syndrome: useful concept or clinical tool? Report of a WHO Expert Consultation. Diabetologia 53, 600–605 (2010). <https://doi.org/10.1007/s00125-009-1620-4>

[3] Kong X., Zhang X., Xing X., et al. The association of type 2 diabetes loci identified in genome-wide association studies with metabolic syndrome and its components in a chinese population with type 2 diabetes // PLoSOne. 2015. Vol. 10, №11. P. e0143607.

[4] Dizaji F. The investigations of genetic determinants of the metabolic syndrome // Diabetes & Metabolic Syndrome: Clinical Research & Reviews. 2018. Vol. 12. P. 783–789.

[5] Barbitoff YA, Tsarev AA, Vashukova ES, et al. A Data-Driven Review of the Genetic Factors of Pregnancy Complications. International Journal of Molecular Sciences. 2020 May;21(9). DOI: 10.3390/ijms21093384.

[6] Adams B, Jacocks L, Guo H. Higher BMI is linked to an increased risk of heart attacks in European adults: a Mendelian randomisation study. BMC Cardiovascular Disorders. 2020 May;20(1):258. DOI: 10.1186/s12872-020-01542-w.

[7] Bu SY. Genetically Mediated Lipid Metabolism and Risk of Insulin Resistance: Insights from Mendelian Randomization Studies. Journal of Lipid and Atherosclerosis. 2019 Sep;8(2):132-143. DOI: 10.12997/jla.2019.8.2.132.

[8] Touyz RM, Rios FJ, Alves-Lopes R, Neves KB, Camargo LL, Montezano AC. Oxidative Stress: A Unifying Paradigm in Hypertension. Can J Cardiol. 2020;36(5):659-670. doi:10.1016/j.cjca.2020.02.081

[9] Crispino, M.; Trinchese, G.; Penna, E.; Cimmino, F.; Catapano, A.; Villano, I.; Perrone-Capano, C.; Mollica, M.P. Interplay between Peripheral and Central Inflammation in Obesity-Promoted Disorders: The Impact on Synaptic Mitochondrial Functions. *Int. J. Mol. Sci.* 2020, 21, 5964.

[10] Leyla Djansugurova, Nazym Altynova, Oksana Cherednichenko, Elmira Khussainova & Yuri E. Dubrova (2020) The effects of DNA repair polymorphisms on chromosome aberrations in the population of Kazakhstan, International Journal of Radiation Biology, 96:5, 614-621, DOI: 10.1080/09553002.2020.1711460

[11] Wojcik G., Graff M., Nishimura K., et al. Genetic analyses of diverse populations improves discovery for complex traits // Nature. 2019. Vol. 570(7762). P. 514-518.

**R.I. Rakhimzhanova¹, D. Pavalkis¹, V.V. Benberin²,
T.B. Dautov¹, Zh.S. Abdrakhmanova¹, E.S. Yelshibayeva^{1,2}**

¹ NpJSC «Astana Medical University» Nur-Sultan, Kazakhstan;

² Medical Centre Hospital of President's affairs Administration
of the Republic of Kazakhstan Nur-Sultan, Kazakhstan.

E-mail: rakhimzhanova01@rambler.ru, pavalkis.d@amu.kz, valeriy-benberin@mail.ru, tairkhan.dautov@gmail.com, zhanna-ayan@rambler.ru, elmiraelsibaeva@gmail.com

COMPLEX ASSESSMENT OF COMPUTED TOMOGRAPHY OF THE LUNGS AND CLINICAL DATA IN COVID-19 PATIENTS, HOSPITALIZED IN THE CLINIC IN NUR-SULTAN

Abstract. The ambiguity of the X-ray picture and clinic in patients with coronavirus infection (CVI) was the reason for this analysis in order to avoid diagnostic errors and to achieve the effect of the treatment.

Conducted a comparative description of three clinical cases of patients with coronavirus infection COVID-19.

All three patients differed in different parameters of SARS Co-2 PCR. In the first two patients who underwent CT on the 7th and 10th days from the onset of the disease on control CT after treatment, a regressive positive dynamics was observed; in the third patient, after an early CT scan on the second day of illness and on the next CT scan performed on the 10th day after the appearance of the clinic and a positive PCR test, progression of signs of viral pneumonia was observed with an increase in the affected area.

Thus, the earlier CT was performed, the less pronounced the changes in the CT picture (the lesion volume is up to 5% or no changes are detected). When performing CT scan, patients with a long-term clinic (7-10 days from the onset of the disease) showed a characteristic picture of lung damage - up to 25-30%. The analysis of CT scans performed in the described clinical cases at different times from the onset of the disease, regardless of the results of PCR, confirms the need for CT scans 5-7 days after the first clinical signs appear. Also, as a result of our work, we once again received confirmation from numerous studies conducted in the world on the absence of a correlation between SARS Co-2 PCR and CT data.

Key words: computed tomography (CT), coronavirus infection, COVID-19, “ground glass” (GGO).

Introduction. The COVID-19 pandemic is a coronavirus infection (CVI) pandemic caused by the SARS-CoV-2 coronavirus [1]. The epidemic began with the detection of the first cases of pneumonia of unknown origin in the city of Wuhan in the Hubei province of central China at the end of December 2019, the origin of which was associated with the Huanan seafood market. On December 31, 2019, China reported an outbreak of unknown pneumonia to the World Health Organization (WHO) [2]. On January 30, 2020, at a meeting of the WHO Emergency Committee, the outbreak of the new coronavirus was declared a public health emergency of global concern [3]. Most of all, WHO was concerned about the possibility of an outbreak of the virus in countries with an underdeveloped health system [4].

In Kazakhstan, the first case of detecting patients with COVID-19 was registered in March 20. To date, in the Republic of Kazakhstan, as of August 1, 20, 91,593 cases of CVI infection were registered. 61 839 people recovered, however, despite the re-introduced quarantine and ongoing epidemiological measures, 6407 cases of coronavirus infection were detected in the last day, 66 patients died. According to the US-based Johns Hopkins University, 17,759,332 people got COVID-19 in the world, 682,855 patients became victims of the infection, and another 10,484,442 people recovered [5]. Radiologists of Kazakhstan, along with infection diseases physicians and pulmonologists, are at the forefront, provide significant assistance in the diagnosis of CVI.

Based on multiple literary sources describing the role of computed tomography (hereinafter referred to as CT) in the diagnosis of pneumonia caused by the COVID-19 virus, the ambiguity of the clinic, CT-picture, the results of timely nucleic acid testing (PCR) and other laboratory data, we set out to analyze own material and compare with the available literature data.

Materials and methods A retrospective analysis of three clinical cases with CT analysis before and after treatment was performed. The patients were treated at the provisional clinic in Nur-Sultan from 20.05 to 20.07.2020. The volume of lung damage was determined referring to the recommendations of Russian scientists: CT-0, zero, lungs unchanged; CT-1, mild with parenchymal involvement = <25%; CT-2, medium-severe with parenchymal involvement 25-50%; CT-3, severe with parenchymal involvement 50-75% and CT-4 critical >= 75% [6]. A point assessment of the degree of lesion was also used, proposed by Xingzhi Xiel, Zheng Zhong, Wei Zhao [7], which states that each lung is divided into three zones: upper (above the carina), middle (below the carina to the lower pulmonary vein) and lower (below the pulmonary vein) ... For each zone: 0 points - 0% engagement; 1 point - less than 25%; 2 points - from 25% to 50%; 3 points - from 50% to 75%; 4 points - 75% or more; 6 zones - the maximum score is 4 points, as a result the total score was summed up - 24 points. Also, to quantify the severity and prevalence of the process by CT, the method proposed by Michael Chung, Adam Bernheim, Xueyan Mei et al. [8] was used, according to which each of the five lung lobes was assessed by the degree of involvement and classified as absence (0%), minimal (1-25%), mild (26-50%), moderate (51-75%) and severe (76-100%).

Research results: Clinical case 1. Patient A., female born in 1966 (54 years old), fell ill for the first time after hypothermia on 13.05.2020, symptoms began with an increase in body temperature from 37 to 39 degrees for 2 days, body aches, chills, pain in the lower abdomen and lumbar region. On 16.05.20., weakness, headache, cough with difficult to separate phlegm, sweating joined. The patient has denied contact with infectious patients in the past 14 days and has not traveled to foreign countries over the past six months, where cases of COVID-19 have been identified. She was self-treated at home with paracetamol. On 05.18.20., due to the deterioration of her condition, she was hospitalized in an infectious diseases' hospital after a positive PCR for the presence of coronavirus infection. Anamnesis: arterial hypertension 3 tbsp. (takes basic therapy), also registered with an endocrinologist with hypothyroidism. Laboratory - ESR up to 20 mm/h.

CT scan was performed upon admission (20.05.20) on the 7th day from the onset of the disease (figure 1) and CT-signs of bilateral polysegmental pneumonia, moderate severity CT-2 (multiple areas of compaction of the " GGO " type, localization, of various lengths, characteristic of the inflammatory process, probably of viral etiology, the volume of lung damage was up to 25%).

Treatment was carried out: aluvia 2 tablets x 2 times inside 10 days, Cef 3 x 1 g x 2 times 14 days, Omez 1 capsule x 2 times a day for 6 days, Clexane 0.4 x 2 times a day for 8 days, Fraxiparin solution 0,3 x 2 times a day. Re-analysis of SARS Co-2 PCR from 20.05.2020 - negative result. On CT from 02.06.20 (figure 2) 2 weeks after treatment, positive dynamics was determined in the form of a decrease in foci with a predominance of compacted foci of consolidation. At discharge, leukocytes, lymphocytes and C-reactive protein were normal, ESR decreased to 15 mm/h.



20.05.20

Figure 1 - CT scan of patient A, 54, upon admission to the clinic (20.05.20)



02.06.20

Figure 2 - CT scan of patient A, 54, in dynamics 13 days after treatment (06.02.20)

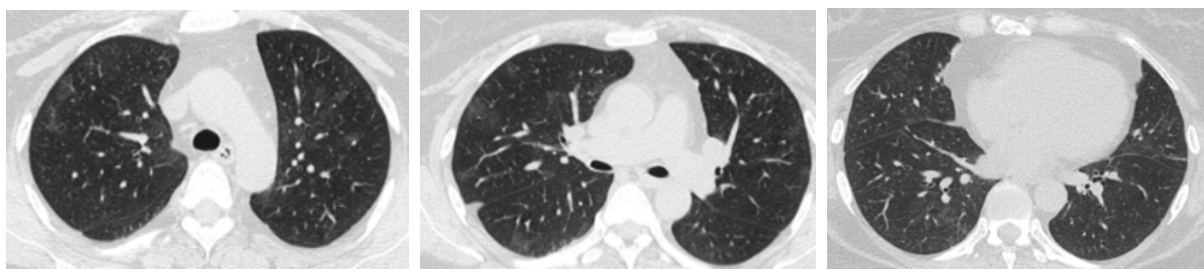

11.07.20

Figure 3 - CT of the lungs of patient A., 54 years old, in dynamics after a month

In dynamics, a month later, the patient was admitted to rehabilitation and CT scan was performed on 11.07.20 (figure 3). CT - positive dynamics (reduction of areas of compaction, the presence of areas of reticular changes and fibrosis).

Clinical case 2. Patient D., male, born in 1971 (49 years old), PCR three times negative (17.06.20, 20.06.20, 29.06.20). He had contact with CVI-infected person (the spouse has a PCR positive from 15.06.20). The first symptoms started from 16.06.20: weakness, nasal congestion and chest pain. He received outpatient azithromycin 500 mg per day for 7 days, Flemoxin Solutab 2000 mg per day for 7 days. On 26/06/2020 got hospitalized for further examination and treatment. Laboratory data on admission: leukocytes 10.2, lymphocytes 4.1, CRP 13 mg/l, ESR 25 mm/h.

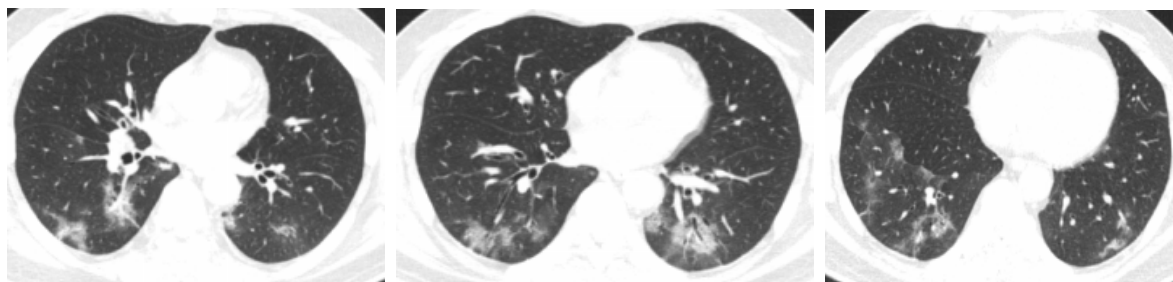

26.06.20

Figure 4 - CT of the lungs of patient D., 49 years old, 10 days after the first symptoms

On 26.06.20., CT of the lungs was performed on the 10th day after the onset of the first symptoms (figure 4), CT scan showed many pathological areas of the "GGO" type, of various forms and localization with a predominant lesion of the lower lobes of the lungs. The volume of lesion of the lung parenchyma was 25%, the degree of lesion according to computed tomography CT-1 (light). Treatment: vitamin C 500mg x 2 times a day; paracetamol 500mg 1 tab x 2 times a day; suprax 400mg 1 tablet 1 time per day for 7 days. On the 14th day after treatment and improvement of the condition (10.07.20), the patient underwent control CT (figure 5). PCR analysis from 07.09.2020. - negative. As can be seen on CT, there is a positive trend, with a significant decrease in the nature of the matte induration in the lungs, in comparison with previous data.

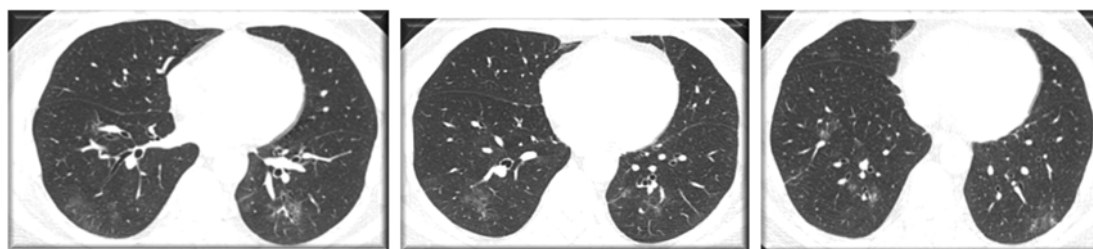

10.07.2020

Figure 5 - CT of the lungs of patient D., 49 years old, 14 days after the previous CT scan

Patient D was discharged for outpatient treatment with improvement on 12.07.20. On discharge, leukocytes, lymphocytes and C-reactive protein were within normal limits, ESR decreased to 12 mm/h.

Clinical case 3. Patient C, male, born in 1963 (57 years old). PCR negative on day 7 after contact with a patient with COVID-19. Fell ill on 22.05.20, general weakness, dry cough. Treatment: taking plenty of fluids, nasal irrigation with saline; aspirin at night; vitamin C 1000mg x 2 times a day. From the anamnesis the patient is not included in the dispensary. In a laboratory study, upon admission, leukocytes, lymphocytes and C-reactive protein are normal, ESR is 15 mm/h.

24.05.20 CT scan of the lungs was performed on day 2 from the onset of the disease (figure 6), according to the picture - signs of single local areas of dullness in the lower lobe of the right lung, perivascular localization, in area up to 5%, causing suspicion and average probability of viral pneumonia, mild severity and observation in dynamics is recommended.



24.05.20

Figure 6 - CT of the lungs of patient S., 57 years old, 2 days after the appearance of the clinic

The patient was prescribed treatment, however, on the 7th day from the onset of the first signs, the patient still complains of sore throat, dry cough, sweating, heaviness in the chest, shortness of breath with little physical exertion, cough with purulent sputum, severe sweating, decreased appetite. When re-taking PCR SARS Co-2 from 01.07.20 - positive result. Taking into account the deterioration of the patient's clinic after the treatment, it was decided to conduct a control CT scan in dynamics after 10 days (figure 7).



04.07.20

Figure 7 - CT of the lungs of patient S., 57 years old, in dynamics 10 days after treatment

On CT 04.07.20 - negative dynamics: an increase in the number and volume of pathological areas of dullness, polygonal forms, intralobar, perivascular and subpleural localization, an area with a

"cobblestone" symptom, the affected area is up to 25%. After the received CT data, the patient's treatment was adjusted: ceftriaxone 1 g. x 2 times a day and a solution of Fraxiparine 0.3 ml subcutaneously. On discharge, leukocytes, lymphocytes and C-reactive protein were normal, ESR decreased to 12 mm/h.

Discussion. All presented clinical cases with symptoms of COVID-19 had ambiguous results of the PCR tests: at the initial sampling, patient 1 had a positive PCR test result, patients 2 and 3 – negative ones. On re-sampling, patient 1 received a negative test result after treatment; patient 2, who was in contact with a CVI infected, had all PCR tests negative; patient 3, who had contact with a CVI infected ones, had his repeated PCR tests positive. All patients came at different times from the onset of symptoms, some were treated at home on their own for several days.

All three patients underwent CT on admission to determine the extent of the lesion and the likelihood of viral pneumonia in case of COVID-19, also over time to monitor and evaluate the effectiveness of treatment. CT scan revealed the primary signs of the disease, their subsequent transformation and the most unfavorable radiation symptoms corresponding to the severe course of the process. The primary symptoms of COVID-19 lung lesions on CT have been described by Xiaoqi Lin, Zhenyu Gong, Zuke Ziao et al. [9].

CT analysis showed that the study was conducted at different periods: patient 1 underwent the first CT scan on the 7th day of illness; patient 2 - on the 10th day from the onset of symptoms. Patient 3 underwent the first CT scan on the 2nd day. Thus, the earlier CT was performed, the less pronounced the changes in the CT picture (the volume of the lesion is up to 5%) or no changes are detected. When conducting CT, patients 5-7 days from the onset of the disease showed a characteristic picture of lung damage - up to 25-30%, which once again confirms the need for CT on 5-12 days after the disease. In case of patient 2 and patient 3, who had a negative PCR result, CT scan showed signs of viral pneumonia, this point once again confirms the lack of correlation between SARS Co-2 PCR and CT data, which was described in their work by Tao Ai and Zheniu Yang, studying 1014 cases on the correlation between CT of the lungs and the results of PCR testing in China. They proved that when comparing the results of PCR for COVID-19, the sensitivity of CT imaging was 97%, chest CT can be considered as the main, but not a screening method for detecting COVID-19 viral pneumonia [19].

In case of patient 2, a 4-fold negative PCR test indicates the absence of the COVID-19 virus. Previously described cases where CT-manifestations of pneumonia of the influenza virus were similar to the picture in COVID-19 [11]. Symptoms of GGO or GGO with consolidation and thickening of the interlobular septum were more often observed, a bilateral process with multiple changes in different lobes of the lungs, and most of them involved all 5 lobes, so it was difficult to distinguish them from each other [12-14]. Pneumonia in case of COVID-19 has a patchy or a combination of GGO with consolidation and mainly affects the peripheral zones, and in case of influenza pneumonia - a cluster pattern and thickening of the bronchial wall in the central and peripheral regions [15]. Also Wang et al. [16] found that with COVID-19, the margins of the lesion are distinct and contoured compared to the flu pattern.

All patients underwent general strengthening, antiviral and antiplatelet treatment. Control CT scans in 1 and 2 patients show the resolution phase with a decrease in the GGO volume, which indicates the correct tactics of the clinician and the timely started antibiotic therapy, which is not indicated at the initial stage of the disease. Detection of early CT changes in the lungs in 3 patients led to unreasonable self-treatment with antibiotics, which were not indicated in viral infection and on CT in dynamics, after a positive PCR - the progression of the process with the transition to a more severe stage of the lesion with signs of consolidation, which is a prognostic sign to determine further treatment tactics [17].

Our patients had initial CT-patterns in COVID-19 (bilateral involvement (88%), "GGO" (88%), posterior distribution (80%), multilobar involvement (79%), peripheral distribution (76%), consolidation (32%), and the presence of stripes in the form of thickening and compaction of interlobular and intersegmental septa) and clinical results with previously reported cases in the literature [10]. Feng Pan, Tianhe Ye, Peng Sun and co-authors [18], based on the analysis of changes in the lungs during dynamic CT observation, proposed to supplement the qualitative characteristics of the degree of lung damage with quantitative ones.

In our work, we also presented the laboratory parameters of patients and determined an increase in leukocytes of patient 3 with a negative CT picture; unexpressed lymphocytopenia of patients 1, 2 and 3 before and after treatment; an increase in C-reactive protein of patient 2 with a positive dynamics of

decrease during treatment and an increase after treatment with progression of CT data of patient 3. ESR values also correlated with treatment and CT picture in all described patients, which is consistent with modern studies [20].

Summarizing the above, we can say the following:

- patient 1: no contact with a CVI infected, with symptoms of the disease, concomitant pathologies, a positive PCR test, a positive effect of therapy - from 25% of lung damage at the first CT scan and 5% of changes during repeated CT after treatment, speaks of the transferred viral pneumonia COVID-19;

- patient 2, who was in contact with a CVI infected, with four-fold negative PCR, presence of a clinic, with pronounced changes (25-30%) on the first CT scan and with good (5%) CT dynamics, quick recovery, speaks more about the transferred influenza virus;

- patient 3, who fell ill 7 days after contact with a CVI infected, weak clinical manifestations, without confirmation of the first PCR test and inconclusive initial CT data, in dynamics with an increase in the CT picture of viral pneumonia on day 10 and a positive second test for COVID-19, speaks of the progression of COVID-19 viral pneumonia with severe and long-term treatment.

The next conclusions follow from the presented work:

- the optimal timing of CT is of great importance, and we recommend carrying out the first CT scan 5-7 days from the onset of symptoms, since early CT scans are insensitive up to 4 days, and the use of CT as a screening method is inappropriate, which is confirmed by the literature data;

- CT in dynamics should be carried out at intervals of 3-5 days from the previous one, depending on the clinic, laboratory data, taking into account PCR testing, concomitant diseases;

- CT has a high sensitivity in detecting both the first CT signs of viral pneumonia, stages of development of the CT picture during dynamic research, and evaluating the effectiveness of treatment. CT data often correlate with the clinic, PCR test indicators, laboratory data, but there are conflicting data, which is confirmed by many modern works.

Conclusion. Computed tomography for COVID-19 is very important, since it may be the first study that will clearly show signs of viral lung damage, determine the stage of the process, assess the severity of the lesion and, of course, adverse prognostic signs of its further development. The accumulated experience of clinical and radiation examination of patients with COVID-19 will improve the radiation semiotics of the process in the lungs, which is important for determining treatment tactics.

**Р.И. Рахимжанова¹, Д. Павалкис¹, В.В. Бенберин²,
Т.Б. Даутов¹, Ж.С. Абдрахманова¹, Э.С. Елшибаева^{1,2}**

¹ «Астана медицина университеті» КеАҚ, Нұр-Сұлтан, Қазақстан;

²Қазақстан Республикасы Президенті Іс басқармасының

Медициналық орталығының ауруханасы, Нұр-Сұлтан, Қазақстан

НҰР-СҰЛТАН ҚАЛАСЫНДА ЕМХАНАҒА ЖАТҚЫЗЫЛҒАН COVID-19 ШАЛДЫҚҚАН НАУҚАСТАР ӨКПЕСІНІҢ КОМПЬЮТЕРЛІК ТОМОГРАФИЯСЫН ЖӘНЕ КЛИНИКАЛЫҚ ДЕРЕКТЕРДІ КЕШЕНДІ БАҒАЛАУ

Аннотация. Коронавирусты инфекция (КВИ) жұқтырған науқастардағы рентгенологиялық көріністердің біркелкі болмауы – емдеу кезіндегі әсерді байқау үшін және диагностикалық шараларды жүргізу барысындағы қателіктердің алдын алу мақсатында осы анализді өткізуге негіз болды. Сондай-ақ ауруханаға жатқызылу алдында және ауруханаға жатқаннан соң COVID-19 расталған науқастарға динамикалық өкпенің компьютерлік томографиясы (КТ) жасалып, өзара салыстырылды.

Нұр-Сұлтан қаласындағы клиниканың провизорлық бөлімшесіндегі COVID-19 коронавирусы инфекциясын жұқтырып, диагностика жасалған және ем қабылдаған үш клиникалық жағдайдың салыстырмалы сипаттамасы жүргізілді. Барлық науқастарға ПЦР тест өткізіліп, зертханалық талдамалар алынып, мульти-спиральді компьютерлік томография жасалды. Мақалада клиникалық сипаттамалар бастапқы кезеңдегі оң ПЦР тест нәтижелерін алғаннан кейінгі КТ көрсетілімдері, зертханалық көрсеткіштер мен динамикалық КТ бақылауының ем курсы алғаннан соңғы нәтижелері салыстырылды. Сондай-ақ мысал ретінде ПЦР теріс нәтижелі науқастардың КТ көрсетілімдерінің кері бағытта даму мәліметтері ұсынылған.

Жұмыс аясында үш науқас зерттеліп, емделді. Олар: 54 жастағы бір әйел және 49 бен 57 жастағы екі ер адам. Барлық зерттеулерге ПЦР SARS Co-2 тесті жасалды. Бірінші жағдайдағы әйел 5 тәуліктен артық суық

тиіп ауырған. 7-тәулікте ПЦР тесттің оң нәтижесін алғаннан соң КТ жасалып, нәтижесінде орта дәрежелі ауырлықтағы вирусты пневмонияның белгілерін көрсеткен. Екінші клиникалық жағдайда суық тию белгілері бар ер адамда ПЦР тест 3 рет теріс нәтиже беріп, қабылдаған емнің әсері болмағаны себепті және зертханалық көрсеткіштердің нашар болуына байланысты сырқаттың 10-тәулігінде КТ жасалып, вирусты пневмония COVID-19-дың жеңіл дәрежесін анықтаған. Үшінші клиникалық жағдайдағы ер адам жіті ауырып, ПЦР тесттің теріс нәтиже бергеніне қарамай, клиникалық белгілері пайда болған екінші тәулікте КТ жасалып, қалыптасу сатысындағы, динамикалық бақылауды қажет ететін күнгірттену ошақтары байқалған. Жоғарыда атап өткеніміздей барлық үш науқаста аурудың мерзімімен, КТ диагностикасын өткізу кезеңімен және ПЦР SARS Co-2 тестінің нәтижелері бойынша өзара айырмашылығы бар. Аурудың 7 және 10-тәулігінде КТ жасалған алғашқы екі науқас ем қабылдап болғаннан кейінгі бақылаулық КТ зерттеулерінде регрессивті, оң динамика байқалған. Аурудың ерте кезеңінің 2-тәулігінде және ПЦР тесттің оң нәтижесінен кейінгі 10-тәулікте КТ жасалған үшінші науқаста вирусты пневмония белгілерінің артып, зақымдалу ошағының ұлғайғаны белгілі болған.

Осылайша КТ қаншалықты ерте өткізілсе, соншалықты КТ көрсетілімдеріндегі өзгерістер аз көрінеді (зақымдалу көлемі 5%-дан аз немесе мүлде көрінбейді). Ұзақ клиникаға ие (сырқаттың 7-10 тәулігінде) науқастардың жасалған КТ нәтижелеріндегі өкпенің зақымдану ошақтары – 25-30%-ға дейін жетеді. Зерттеу көрсеткендей, COVID-19 кезіндегі пневмонияның ең жиі белгілері ретінде – екі жақты үдеріс (75%), «ұнтақталған әйнек» симптомы (85,7%), дақты дақ консолидациясы (19,0%), субплевралық локализациямен, сондай-ақ қабықшалар аралық және сегмент аралық қалқандарда тығыздалу түрінде жолақтар пайда болған. Ұсынылған клиникалық жағдайда сырқаттың әртүрлі сатыларында өткізілген КТ талдамалары – ПЦР тестінің нәтижесіне тәуелсіз түрде, аурудың алғашқы клиникалық белгілері пайда болғаннан кейінгі 5-7 тәулікте КТ өткізу қажеттілігін растайды. Сондай-ақ біз жүргізген жұмыс барысында әлемде жасалып жатқан зерттеулер қорытындысына сай келетін ПЦР SARS Co-2 және КТ мәліметтері арасындағы корреляцияның жоқтығын тағы да бір рет растадық.

Түйін сөздер: компьютерлік томография, коронавирусты инфекция, COVID-19, «күнгірт шыны» симптомы.

**Р. И. Рахимжанова¹, Д. Павалкис¹, В. В. Бенберин²,
Т. Б. Даутов¹, Ж. С. Абдрахманова¹, Э. С. Ельшибаева^{1,2}**

¹НАО «Медицинский университет Астана» г. Нур-Султан, Казахстан;

²РГП «Больница Медицинского Центра Управления делами Президента
Республики Казахстан» г. Нур-Султан, Казахстан

КОМПЛЕКСНАЯ ОЦЕНКА КОМПЬЮТЕРНОЙ ТОМОГРАФИИ ЛЕГКИХ И КЛИНИЧЕСКИХ ДАННЫХ У ПАЦИЕНТОВ С COVID-19, ГОСПИТАЛИЗИРОВАННЫХ В КЛИНИКУ Г. НУР-СУЛТАН

Аннотация. Неоднозначность рентгенологической картины и клиники у пациентов с коронавирусной инфекцией (КВИ) послужило поводом проведения данного анализа во избежание диагностических ошибок и для достижения эффекта от проводимого лечения. При этом сравнивали результаты компьютерной томографии (КТ) легких пациентов, прошедших при поступлении и в динамике с подтвержденным COVID-19, госпитализированных в стационар.

Провели сравнительную характеристику трех клинических случаев пациентов с коронавирусной инфекцией COVID-19, проходивших диагностику и лечение в провизорном отделении клиники города Нур-Султан. Всем пациентам проводили ПЦР-тестирование, лабораторные анализы, компьютерную томографию на мультиспиральном компьютерном томографе. В работе описаны клинические характеристики, данные компьютерной томографии на начальном этапе после получения положительного теста, сравнение с лабораторными показателями и динамическое наблюдение по КТ-картине после проведенного курса лечения, также приведены примеры КТ исследований пациентов с отрицательной ПЦР и прогрессирование КТ-картины.

Было обследовано и пролечено трое пациентов: одна женщина, 54 лет и двое мужчин, 49 и 57 лет. Всем пациентам провели ПЦР SARS Co-2. В первом клиническом случае – женщина болела симптомами простуды более 5 дней, после был получен положительный тест на ПЦР и на 7 день проведена КТ, где описана картина вирусной пневмонии средней степени тяжести. Во втором клиническом случае у мужчины с простудной симптоматикой ПЦР тест трижды показал отрицательный результат, учитывая отсутствие динамики от лечения и плохие лабораторные показатели на 10 день от начала болезни пациенту провели КТ, где выявились признаки вирусной пневмонии COVID-19 легкой степени. В третьем клиническом случае

мужчина заболел остро, несмотря на отрицательный результат ПЦР, на 2 день от начала клиники провели КТ, где выявились подозрительные участки, с подозрением на вирусную пневмонию, вероятнее всего, формирующиеся и требующие динамического наблюдения. Как следует из вышеописанного, все трое пациентов отличались между собой сроками заболевания, проведения КТ-диагностики и разными показателями ПЦР SARS Co-2. У первых двух пациентов, которым КТ было проведено на 7 и 10 день от начала заболевания, на контрольных КТ после лечения наблюдалась регрессивная положительная динамика; у третьего пациента после проведенного раннего КТ на второй день болезни и на следующем КТ, проведенном на 10 день от появления клиники и положительного теста ПЦР, наблюдали прогрессирование признаков вирусной пневмонии с увеличением площади поражения.

Таким образом, чем раньше было проведено КТ, тем менее выражены изменения КТ-картины (объем поражения до 5% или никаких изменений не выявляется). При проведении КТ пациентам с длительной клиникой (на 7-10 день от начала заболевания) отмечена характерная картина поражения легких – до 25-30%. Исследование показало, что наиболее частыми признаками пневмонии при COVID-19 являются двухсторонний процесс (75%), симптом «матового стекла» (85,7%), пятнистая консолидация (19,0%) с субплевральной локализацией, также наличие полосок в виде утолщения и уплотнения межлобулярных и межсегментарных перегородок. Анализ проведенных КТ в описанных клинических случаях в разные сроки от начала заболевания, независимо от результатов ПЦР, подтверждает необходимость проведения КТ на 5-7 сутки после появления первых клинических признаков. Также в результате проведенной нами работы еще раз получили подтверждение многочисленные исследования, проведенные в мире на отсутствие корреляции между ПЦР SARS Co-2 и КТ-данными.

Ключевые слова: компьютерная томография, коронавирусная инфекция, COVID-19, симптом “матовое стекло”.

Information about authors:

Rakhimzhanova R.I., Professor, Doctor of Medical Science, the Headmaster radiology named after academician J.H. Hamzabaev NpJSC "AMU", the President of Kazakhstan mammologis association and movemend «No cancer in a beast», Honored of the RK, Academician of APM, the President of Radiological Society of Kazakhstan; rakhimzhanova01@rambler.ru; <https://orcid.org/0000-0001-9564-1609>;

Pavalkis D., Professor, Doctor of Medical Science, Rector of NpJSC "Astana Medical University"; pavalkis.d@amu.kz; <https://orcid.org/0000-0001-7339-3237>;

Benberin V., Doctor of Medical Sciences, Professor, corresponding member of the National Academy of Sciences of Kazakhstan, Director of the «Medical Centre Hospital of President's affairs Administration of the Republic of Kazakhstan»; valeriy-benberin@mail.ru; <https://orcid.org/0000-0002-7286-1593>;

Dautov T.B., Professor, Doctor of Medical Science, vice-President of Radiological Society of Kazakhstan. Chief of Department of Radiology of National Scientific Cardiac Surgery Center, prof. of the department radiology named after academician J.H. Hamzabaev NpJSC "AMU"; tairkhan.dautov@gmail.com; <https://orcid.org/0000-0002-5267-0108>;

Abdrakhmanova Zh.S., Associate Professor, Doctor of Medical Science, the Headmaster of the Department of Radiology NpJSC "AMU"; zhanna-ayan@rambler.ru; <https://orcid.org/0000-0002-1890-0862>;

Yelshibayeva E.S., Assistant of the Department Radiology named after academician J.H. Hamzabaev NpJSC "AMU", MRI and CT doctor of the «Medical Centre Hospital of President's affairs Administration of the Republic of Kazakhstan»; elmiraelsibaeva@gmail.com; <https://orcid.org/0000-0001-6264-1880>

REFERENCES

[1] Guan W.J., Ni Z.Y., Hu Y. et al. China Medical Treatment Expert Group for Covid-19. Clinical Characteristics of Coronavirus Disease 2019 in China. *N Engl J Med.* 2020 Feb 28. <https://doi: 10.1056/NEJMoa2002032>

[2] Huang C., Wang Y., Li X., Ren L., Zhao J., Hu Y., Zhang L., Fan G., Xu J., Gu X., Cheng Z. Clinical features of patients with 2019 novel coronavirus in Wuhan, China. *Lancet.* 2020 Jan 24. [https://doi: 10.1016/S0140-6736\(20\)30183-5](https://doi: 10.1016/S0140-6736(20)30183-5)

[3] General Office of National Health Committee. Notice on the issuance of a program for the diagnosis and treatment of novel coronavirus (2019-nCoV) infected pneumonia (trial sixth edition) 2020. <http://www.nhc.gov.cn/yzygj/s7653p/202002/8334a8326dd94d32>

[4] World Health Organization. Novel coronavirus–China. <http://www.who.int/csr/don/12-january-2020-novel-coronavirus-china/en>. 12 January 2020.

[5] Hotline of the Ministry of Health of the Republic of Kazakhstan. <https://www.coronavirus2020.kz/>

[6] Morozov S.P., Ledikhova N.V., Lobanov M.N., Turavilova E.V. Classification according to the degree of change in chest CT studies, suspicious of COVID-19 (CT0-CT4). Moscow 2020r. Series «Best practices in radiation and instrumental diagnostics». Release. 65. M.: GBUZ «NPKZ DiT DZM», 2020. 80 p. ISSN 2618-7124

[7] Xingzhi Xiel, Zheng Zhong, Wei Zhao/ Chest CT for Tupal 2019-nCov Pneumonia: Relationship to Negative RT-PCR. Published Online: *Radiology* Feb.13.2020; 296: E41-E45. <https://doi.org/10.1148/radiol.2020200343>

- [8] Ghung M., Bernheim A., Mei X. et al. CT Imaging Features of 2019 Novel Coronavirus (2019-nCov). Published Online. Feb. 4. 2020. <https://doi.org/10.1148/radiol.2020200230>
- [9] Xiaoqi Lin, Zhenyu Gong, Zuke Xiao, Jingliang Xiong, et al. Novel Coronavirus Pneumonia Outbreak in 2019: Computed Tomographic Findings in Two Cases/Korean J Radiol. 2020 Mar. 21(3): 365–368. Published online 2020 Feb. 11. <https://doi.org/10.3348/kjr.2020.0078>
- [10] Xiaoyan Hu, M.Sa, Jie Gou, B.Sa, Liang Guo, M.Sb. Clinical features and chest CT findings of 3 cases of 2019 novel coronavirus (COVID-19) pneumonia. Department of Radiology, Chengdu First People's hospital. 19 June 2020 Available online at www.sciencedirect.com Radiol. Case Rep 2020 Sep; 15(9): 1609–1613. Published online 2020 Jun 19. <https://doi.org/10.1016/j.radcr.2020.06.031> PMID: 32685080
- [11] Wang Q, Zhang Z, Shi Y, Jiang Y. Emerging H7N9 influenza A (novel reassortant avian-origin) pneumonia: radiologic findings. *Radiology* 2013; 268(3):882-889. <https://doi.org/10.1148/radiol.13130988>
- [12] Kim MC, Kim MY, Lee HJ, Lee SO, Choi SH, KIM YS, et al. CT findings in viral lower respiratory tract infections caused by parainfluenza virus, influenza virus and respiratory syncytial virus. *Medicine (Baltimore)* 2020;95:e4003. <https://doi.org/10.1097/MD.0000000000004003>.
- [13] Pan Y, Guan H, Zhou S, Wang Y, Li Q, Zhu T, et al. Initial CT findings and temporal changes in patients with the novel coronavirus pneumonia (2019-nCoV): a study of 63 patients in Wuhan, China. *Eur Radiol* 2020. <https://doi.org/10.1007/s00330-020-06731-x>
- [14] Lei J, Li J, Li X, Qi X. CT Imaging of the 2019 Novel Coronavirus (2019-nCoV) Pneumonia. *Radiology*. 2020. 295(1):18. <https://doi.org/10.1148/radiol.2020200236>
- [15] Koo HJ, Lim S, Choe J, Choi SH, Sung H, Do KH. Radiographic and CT features of viral pneumonia. *Radiographics* 2018;38(3):719-739. <https://doi.org/10.1148/rg.2018170048>
- [16] Wang H, Wei R, Rao G, Zhu J, Song B. Characteristic CT findings distinguishing 2019 novel coronavirus disease (COVID-19) from influenza pneumonia. *Eur Radiol* 2020. <https://doi.org/10.1007/s00330-020-06880-z>
- [17] Junqiang Lei, Junfeng Li, Xun Li et al. CT Imaging of the 2019 Novel Coronavirus (2019-nCoV) Pneumonia. Published Online. Jan. 31. 2020. <https://doi.org/10.1148/radiol.20220200236> • ©RSNA, 2020
- [18] Feng Pan, Tianhe Ye, Peng Sun et al. Time Course of Lung Changes On Chest CT During Recovery From 2019 Novel Coronavirus (COVID-19) Pneumonia. Published Online: Feb. 13. 2020. *Radiology*; 295(3):715-721. <https://doi.org/10.1148/radiol.2020200370>
- [19] Ai T, Yang Z, Hou H, et al. Correlation of Chest CT and RT-PCR Testing for Coronavirus Disease 2019 (COVID-19) in China: A Report of 1014 Cases. *Radiology* 2020; 296(2):E32-E40. <https://doi.org/10.1148/radiol.2020200642>
- [20] Huang C, Wang Y, Li X, et al. Clinical features of patients infected with 2019 Novel coronavirus in Wuhan, China. [published correction appears in *Lancet*. 2020 Jan 30:]. *Lancet*. 2020. 395(10223):497-506. [https://doi.org/10.1016/S0140-6736\(20\)30183-5](https://doi.org/10.1016/S0140-6736(20)30183-5)

**REPORTS OF THE NATIONAL ACADEMY OF SCIENCES
OF THE REPUBLIC OF KAZAKHSTAN**

ISSN 2224-5227

<https://doi.org/10.32014/2020.2518-1483.125>

Volume 5, Number 333 (2020), 103 – 108

UDC 004.051

A.A. Amantay, K.S. Duisebekova

International Information Technology University, Almaty, Kazakhstan.

E-mail: aryn0902@gmail.com, dkulan1@mail.ru**APPLICATION OF MEDICAL INFORMATION SYSTEMS
IN EDUCATION AND RESEARCH IN MEDICINE**

Abstract. Medical information systems (MIS) - in a broad sense, it is a form of organization in medicine, uniting in the process of activities of physicians, mathematicians, technicians with a complex of technical means and providing the collection, storage, processing, analysis and delivery of medical information of various profiles in the process of solving problems, and in the narrow sense - a complex of mathematical and technical means to ensure the collection, storage, processing and issuance of medical information in solving problems of clinical medicine or health. The general commands for planning and implementing a medical information system are very large and rich. There are necessary requirements for personnel, capital, and the organization itself. Strict requirements for high reliability and user utility for a real-time system significantly increase hardware and software requirements. The scale of the information system requires careful time planning and modular implementation.

Keywords: information technology, medical information system, medical prophylactic establishments.

Introduction. In the era of mass introduction of personal computers in all areas of modern life, it is natural to seek to use computer systems to support increasingly complex human activities. The healthcare system has long been in urgent need of modern information technologies; complex business processes, expensive resources, industrial scale of medical care, quality of treatment, standardization of medical services-all this requires the introduction of information and computer technologies. In addition, information technologies can effectively reduce costs and optimize the health care system. The use of information technologies in solving professional problems becomes an integral part of the work of a doctor of any specialty. Of course, a doctor should know his or her subject area and be able to use information and computer technologies when performing professional duties [1].

Informatization is a set of measures aimed at timely and complete provision of necessary information to the participants of a particular activity, processed in a certain way and, if necessary, transformed. Informatization of the health care system is a multi-aspect system-forming process that includes the collection and accumulation of information, its transmission, integration and effective use of databases, data banks and knowledge about the industry. The health management system is a multi-level dynamic system with types of reporting and reporting. The implementation of health functions at various levels of this complex is inextricably linked to information. A key element of the Informatization of health care is a medical information system. Medical information system-a set of information, organizational, software and hardware tools designed to automate medical processes and (or) organizations.

Analyzing. The process of analyzing the subject area in the development of information systems involves identifying the main and auxiliary business processes that are designed to ensure the production of a product/service. However, along with this, the selection and review of business processes provides an opportunity to determine the business elements and data structures that should participate in data processing. Such capabilities require the information system developer to use not only the documents used in the domain activity in modeling the database, but also the environment of each business process and functions, including the definition of business elements, data objects, processing executors, owners of

processes and functions, previous and subsequent functions, initiating and resulting events, and other elements. The depth of consideration of business processes and functions provides the most complete information about the processes occurring in the subject area, and allows you to better understand the tasks that need to be implemented when developing a database, which include modeling the database structure, determining the rules of referential integrity, forming procedures for processing and presenting data, but user requests. [2]

A specialized medical information system for medical institutions must meet several requirements: quality of execution, user-friendly interface for all users, information security, and budget cost.

Sometimes representatives of medical institutions order the download of a medical information system from the Internet in order to save money. This decision is usually dictated by ignorance. In fact, there is no free medical information system for medical institutions. On the Internet, you can find demo (test) versions of various specialized information programs for various institutions. As a rule, such specialized information programs have a limited period of validity and incomplete functionality. Since the competition in the information technology market among specialized medical institutions is quite high, each developer seeks to limit access to the system of their institutions in order to preserve the unique functions and author's developments in the field of information programs for medical institutions. That is why it is impossible to publish a high-quality medical information system for free on the Internet. Such systems for specialized agencies are usually purchased from the creators.

Development of healthcare using information technologies:

- Support for research in organic chemistry, biology, genetics, etc.
- Development of evidence-based medicine and clinical research methods;
- Image analysis;
- Improving the efficiency of medical services. (automation of business processes, creation of electronic registers, analysis of complex structured data and texts in natural language)

Based on the analysis of foreign literature and computational experiments, it is shown that the introduction of information technologies has high potential economic benefits for hospitals. Today, many medical centers use the "old" method, only paper. With the help of information systems, you can increase your customer base, save time, etc.

Component diagrams are used to visualize the organization and relationships between components in the system. These diagrams show the physical components of the system. To clarify this, we can say that component diagrams describe the organization of components in a system. Here we can see the main physical components of the system.

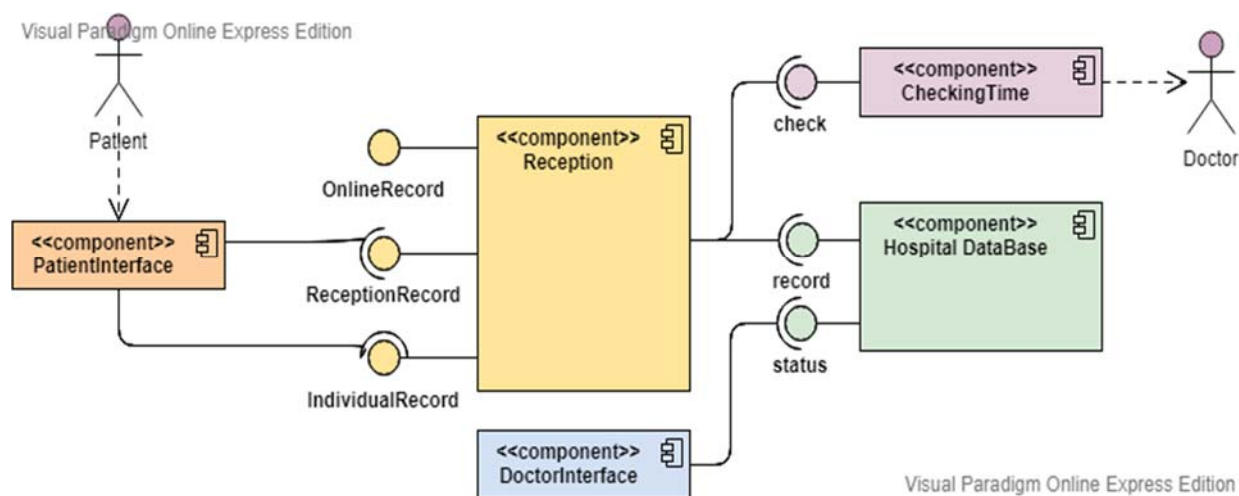

Figure 1 - Component diagram

Automation of business processes is a phenomenon that is gaining more and more popularity in the modern market. In addition, this is absolutely justified - because automation mechanisms allow first to reduce the costs of any production, and therefore-to make the company's activities more efficient. [3]

Understanding what business automation is and what it gives, we should note the following positive aspects of its introduction:

- Elimination of routine and monotonous manual labor;
- Information is processed and transmitted much faster;
- In a single information space, individual divisions or the entire enterprise are served;
- Programmed reports and documents are generated automatically;
- The convenience of operating databases increases, and the work becomes more accurate, complete, and consistent;
- Divisions or the entire organization is reduced to a single complex, which combines regular standardized document flow and information and regulatory framework. [4]

Similar to all other production areas, focus on optimizing primary production and automation of key business processes inherent in medical prophylactic establishments (further - MPE), implementing medical information system (hereinafter - MIS).

To effectively address this issue of information support for accounting and management processes in any modern MIS, a large number of functions must be implemented that solve many problems. At the same time, the functionality of each specific MIS may differ for each of the presented logical blocks. In addition, in most cases, the specifics of large MPE require unique MIS functionality developed directly for the specific goals of a particular organization. Thus, the best option for the information technology platform for automating business processes in a multi-disciplinary health care facility is a basic MIS, modified to take into account the individual specifics and tasks of the institution. [5]

Despite the huge number of advantages, this approach has its own weaknesses. The production system will become much more complex and there will be a lot of new elements that the company's employees may not be familiar with, so you will have to spend time training them. In addition, the equipment will require greater reliability. Constant support of specialists is important. The staff must have a programmer with special knowledge. For example, if the accounting Department is being automated, it should be aware of the current legislation in this area. [6]

It is worth noting that these unavoidable difficulties are temporary and more than pay for the benefits that automation brings in the end. Over time, imperfections in the information and financial databases are smoothed out, and employees get used to the new order of work. Even those who looked at innovations with distrust, realize their convenience. With the most pessimistic forecast, the economic effect is noticeable in a few years, and according to the average data-much earlier. [7][8]

Conclusion. It becomes obvious that the health and prosperity of the entire nation will depend on the effectiveness of the introduction of medical information technologies in medicine. Many domestic medical institutions actively use the services of complex medical information systems in their activities. The latter are a complete (universal) software product that allows you to manage the activities of medical institutions and provide medical services at a qualitatively new level.

The peculiarity of medical information systems is the transition from local work with medical information to an integrated system, where all data passing through the institution is accessible from a single information environment. Paperless technology is fully implemented, but you can still get a copy of any document. The use of modern medical technologies makes it possible to improve the quality of medical services, optimize the management of various structural divisions of medicine and create a basis for reaching the world level of medical care. The era of paper information and self-written programs for medical institutions is being replaced by the time of large information systems aimed at both maintaining internal functions and solving problems of managing the medical industry

А.А. Амантай, К.С. Дуйсебекова

Международный университет информационных технологий, Алматы, Казахстан

ПРИМЕНЕНИЕ МЕДИЦИНСКИХ ИНФОРМАЦИОННЫХ СИСТЕМ В ОБРАЗОВАНИИ И НАУЧНЫХ ИССЛЕДОВАНИЯХ В МЕДИЦИНЕ

Аннотация. Медицинские информационные системы (МИС) в широком смысле – это форма организации в медицине, объединяющая в процессе своей деятельности врачей, математиков, техников с комплексом технических средств и обеспечивающая сбор, хранение, обработку, анализ и доставку медицинской информации различного профиля в процессе решения задач, а в узком смысле – комплекс математических и технических средств, обеспечивающих сбор, хранение, обработку и выдачу медицинской информации при решении задач клинической медицины или здравоохранения. Общие команды для планирования и внедрения медицинской информационной системы очень велики и богаты. Есть необходимые требования и к персоналу, и к капиталу, и к самой организации. Строгие требования к высокой надежности и полезности пользователя для системы реального времени значительно повышают требования к аппаратному и программному обеспечению. Масштаб информационной системы требует тщательного планирования времени и модульного внедрения. Динамично растущие медицинские информационные системы (МИС) знаменуют собой эру больших данных в области здравоохранения. Эти данные имеют большое значение для управления рабочими процессами, ухода за пациентами и их лечения, научных исследований и образования в сфере здравоохранения. Однако сложный, распределенный и в высшей степени междисциплинарный характер медицинских данных подчеркивает ограниченность традиционных возможностей анализа данных для доступа к ним, их хранения, обработки, анализа, распространения и совместного использования. Новые и эффективные технологии становятся необходимыми для получения огромного объема информации и знаний, лежащих в основе больших медицинских данных. Обсуждение медицинского анализа больших данных в его работе, включая введение в фундаментальные концепции, связанные с ними платформы и технологии обработки больших медицинских данных, а также передовые технологии обработки больших данных.

Индустрия здравоохранения опирается на огромное количество данных для принятия решений о лечении пациентов, облегчения оказания медицинской помощи и решения многих сложных административных задач, которые происходят за кулисами. Информационные системы здравоохранения являются ценными инструментами, которые помогают клиницистам и административному персоналу обеспечить непрерывный опыт пациента от начала до конца. Другие преимущества включают в себя:

- Аналитику данных – помощь в сборе и анализе данных для управления здоровьем населения и снижения затрат на здравоохранение.
- Поддержку совместного ухода – МИС облегчает совместное использование ЗМИ (Защищенная Медицинская Информация) между поставщиками и организациями, что позволяет пациентам получать скоординированную помощь от нескольких поставщиков, одновременно улучшая качество оказания медицинской помощи и результаты лечения пациентов.
- Контроль затрат – путем обмена информацией МИС может устранить дубликаты тестирования и процедур, сократить временные затраты на персонал (например, для отправки бумажных копий записей пациентов) и уменьшить дорогостоящие человеческие ошибки.
- Управление здоровьем населения – агрегирование данных о пациентах может помочь выявить закономерности и тенденции, прогнозировать или предотвращать вспышки, выявлять группы риска и многое другое.
- Поддержку клинических решений – интеграция индивидуальных данных пациента и истории болезни с более широкими популяционными данными и исследованиями улучшает как диагностику, так и лечение.

Электронные системы медицинской документации повышают качество обслуживания пациентов и уменьшают количество врачебных ошибок, однако их финансовые последствия не были так хорошо задокументированы. Сейчас проводятся исследования затрат и выгод для анализа финансовых эффектов электронных систем медицинской документации в амбулаторных учреждениях первичной медико-санитарной помощи с точки зрения организации здравоохранения. Данные были получены из исследований из опубликованной литературы. Эталонной стратегией для сравнения была традиционная бумажная медицинская карта. Внедрение системы электронной медицинской документации в первичной медико-санитарной помощи может привести к положительной финансовой отдаче от инвестиций в организацию здравоохранения. Величина отдачи чувствительна к нескольким ключевым факторам.

Ключевые слова: информационные технологии, медицинская информационная система, лечебно-профилактические учреждения.

А.А. Амантай, К.С. Дүйсебекова

Халықаралық ақпараттық технологиялар университеті, Алматы, Қазақстан

МЕДИЦИНАДА ҒЫЛЫМИ ЗЕРТТЕУЛЕРДІ ЖӘНЕ БІЛІМ БЕРУДЕ МЕДИЦИНАЛЫҚ АҚПАРАТТЫҚ ЖҮЙЕЛЕРДІ ҚОЛДАНУ

Аннотация. Медициналық ақпараттық жүйелер (МАЖ) кең мағынада қызмет үдерісінде дәрігер, математик, техниканы техникалық құралдар кешенімен біріктіретін және міндеттерді шешу үдерісінде түрлі бейіндегі медициналық ақпаратты жинау, сақтау, өңдеу, талдау және жеткізуді қамтамасыз ететін медицинадағы ұйым нысаны, ал тар мағынада клиникалық медицина немесе денсаулық сақтау міндеттерін шешу барысында медициналық ақпаратты жинау, сақтау, өңдеу және беруді қамтамасыз ететін математикалық және техникалық құралдар кешені. Медициналық ақпараттық жүйені жоспарлау және енгізу үшін жалпы командалар өте үлкен және бай. Қызметкерге, капиталға және ұйымның өзіне қажетті талаптары бар. Нақты уақыт жүйесі үшін жоғары сенімділік пен пайдаланушыға ыңғайлы болуы үшін қатаң талаптар аппараттық және бағдарламалық жасақтамаға қажеттілікті едәуір арттырады. Ақпараттық жүйенің ауқымы уақытты мұқият жоспарлау мен модульді енгізуді талап етеді. Динамикалық артып келе жатқан медициналық ақпараттық жүйелер (МАЖ) Денсаулық сақтау саласындағы үлкен деректер дәуірін білдіреді. Бұл деректер жұмыс үдерісін басқару, пациенттерді күту және оларды емдеу, денсаулық сақтау саласындағы ғылыми зерттеулер мен білім беруде үлкен маңызға ие. Алайда медициналық деректердің күрделі, бөлінген және жоғары дәрежеде пәнаралық сипаты қол жеткізу, сақтау, өңдеу, талдау, тарату және бірлесіп пайдалану үшін деректерді талдаудың дәстүрлі мүмкіндіктерінің шектеулілігін көрсетеді. Жаңа және тиімді технологиялар үлкен медициналық деректер негізіндегі ақпарат пен білімнің ірі көлемін алу үшін қажет. Жұмыс барысына көлемді деректердің медициналық талдануын талқылау, соның ішінде іргелі тұжырымдамаларға енгізу, соған байланысты платформалар мен үлкен медициналық деректерді өңдеу технологиясы, сондай-ақ ірі деректерді өңдеудің алдыңғы қатарлы технологиялары кіреді.

Денсаулық сақтау саласы пациенттерге күтім жасау, медициналық көмек көрсетуді жеңілдету және көптеген күрделі әкімшілік міндеттерді шешу туралы шешімдер қабылдау үшін көптеген мәліметтерге сүйенеді. Денсаулық сақтаудың ақпараттық жүйелері клиницистер мен әкімшілік қызметкерлерге пациенттің басынан аяғына дейін үздіксіз тәжірибесін қамтамасыз етуге көмектесетін құнды құралдар болып саналады. Келесідей басқа артықшылықтарды да қамтиды:

- деректерді талдау – халықтың денсаулығын басқару және денсаулық сақтау шығынын азайту үшін деректерді жинау мен талдауға көмек көрсету;

- бірлескен күтімді қолдау – МАЖ жеткізушілер мен ұйымдар арасында ҚМА (қорғалған медициналық ақпарат) бірлесіп пайдалануды жеңілдетеді әрі бұл пациенттерге медициналық көмек көрсету сапасы мен пациенттерді емдеу нәтижелерін бір мезгілде жақсарта отырып, бірнеше жеткізушіден үйлестірілген көмек алуға мүмкіндік береді;

- шығынды бақылау – МАЖ ақпарат алмасу арқылы тестілеу мен процедуралардың дубликаттарын жою алады, қызметкерге арналған уақытша шығынды қысқартады (мысалы, пациент жазбаларының қағаз көшірмелерін жіберу) және қымбат тұратын адами қателіктерді азайта алады;

- халық денсаулығын басқару – пациенттер туралы деректерді біріктіру заңдылықтар мен үрдістерді анықтауға, жарқылды болжауға немесе алдын алуға, қауіпті топтарды анықтауға және т.б. көмектеседі;

- клиникалық шешімдерді қолдау – пациенттің жеке деректерін және ауру тарихын кең таралған деректермен және зерттеулермен интеграциялау диагностиканы да, сондай-ақ емдеу ісін де жақсартады.

Медициналық құжаттаманың электрондық жүйелері пациенттерге қызмет көрсету сапасын арттырады және дәрігердің қателіктер санын азайтады, алайда олардың қаржылық салдары жетік құжатталған жоқ. Қазір денсаулық сақтау ұйымы тұрғысынан алғашқы медициналық-санитарлық көмектің амбулаториялық мекемелерде медициналық құжаттаманың электрондық жүйесінің қаржылық әсерін талдау үшін шығын мен пайда зерттелуде. Деректер жарияланған әдебиеттерден алынды. Салыстыру үшін эталондық стратегия ретінде дәстүрлі қағаз медициналық карта алынды. Алғашқы медициналық-санитариялық көмек көрсетуде электрондық медициналық құжаттама жүйесін енгізу Денсаулық сақтау ұйымына инвестициядан оң қаржылық қайтарым болуы мүмкін. Қайтарым мөлшері бірнеше негізгі факторларға әсер етеді.

Түйін сөздер: ақпараттық технологиялар, медициналық ақпараттық жүйе, емдеу, алдын алу мекемелері.

Information about author:

Duisebekova K.S., Doctor of Physical-Mathematical Sciences, PhD, Associate Professor, Department of Information System, Information Technology, International Information Technology University, Kazakhstan; dkulan1@mail.ru;

Amantay A.A., Bachelor of Engineering and Technology, Department of Information System, Information Technology, International Information Technology University, Kazakhstan; aryn0902@gmail.com;

REFERENCES

- [1] Freedman, Seth, et al. "Information Technology and Patient Health: Analyzing Outcomes, Populations, and Mechanisms." *Information Technology and Patient Health: Analyzing Outcomes, Populations, and Mechanisms*, AMERICAN JOURNAL OF HEALTH ECONOMICS, Winter, 2018
apps.webofknowledge.com/full_record.do?product=WOS&search_mode=GeneralSearch&qid=3&SID=D6Q8yNVfcGzi6aBkGDW&page=1&doc=5.
- [2] Ezabadi, Zahra, et al. Satisfaction with Information Provided to Infertile Patients Who Undergo Assisted Reproductive Treatment. ROYAN INST, PO BOX 19395-4644, TEHRAN, 00000, IRAN, 2019,
apps.webofknowledge.com/full_record.do?product=WOS&search_mode=GeneralSearch&qid=11&SID=D6Q8yNVfcGzi6aBkGDW&page=1&doc=4.
- [3] Chauhan, Ritu K, et al. "Predictive Data Analytics Technique for Optimization of Medical Databases." *Predictive Data Analytics Technique for Optimization of Medical Databases*, Springer Verlag, 22 Dec. 2017,
[www.scopus.com/record/display.uri?eid=2-s2.0-85053890886&origin=resultslist&sort=plf-f&src=s&st1=Medical Information System&st2=&sid=d9d9f010e51ae950a4c7baa21879e60d&sot=b&sdt=b&sl=60&s=TITLE-ABS-KEY\(Medical Information System\) AND PUBYEAR > 2012&relpos=12&citeCnt=0&searchTerm=](https://www.scopus.com/record/display.uri?eid=2-s2.0-85053890886&origin=resultslist&sort=plf-f&src=s&st1=Medical Information System&st2=&sid=d9d9f010e51ae950a4c7baa21879e60d&sot=b&sdt=b&sl=60&s=TITLE-ABS-KEY(Medical Information System) AND PUBYEAR > 2012&relpos=12&citeCnt=0&searchTerm=).
- [4] Dadunashvili, Sergo A. "Medical Expert System with the Properties of Artificial Intelligence." *Medical Expert System with the Properties of Artificial Intelligence*, Springer Verlag, 8 June 2018, [www.scopus.com/record/display.uri?eid=2-s2.0-85048262620&origin=resultslist&sort=plf-f&src=s&st1=Medical Information System&nlo=&nlr=&nls=&sid=d9d9f010e51ae950a4c7baa21879e60d&sot=b&sdt=b&sl=60&s=TITLE-ABS-KEY\(Medical Information System\) AND PUBYEAR > 2012&relpos=32&citeCnt=0&searchTerm=](https://www.scopus.com/record/display.uri?eid=2-s2.0-85048262620&origin=resultslist&sort=plf-f&src=s&st1=Medical Information System&nlo=&nlr=&nls=&sid=d9d9f010e51ae950a4c7baa21879e60d&sot=b&sdt=b&sl=60&s=TITLE-ABS-KEY(Medical Information System) AND PUBYEAR > 2012&relpos=32&citeCnt=0&searchTerm=).
- [5] Vermuyten, Hendrik, et al. "Integrated Staff Scheduling at a Medical Emergency Service: An Optimisation Approach." *Integrated Staff Scheduling at a Medical Emergency Service: An Optimisation Approach*, PERGAMON-ELSEVIER SCIENCE LTD, THE BOULEVARD, LANGFORD LANE, KIDLINGTON, OXFORD OX5 1GB, ENGLAND, 1 Dec. 2018,
apps.webofknowledge.com/full_record.do?product=WOS&search_mode=GeneralSearch&qid=3&SID=F54ANAbQA6CulGlgduE&page=1&doc=42.
- [6] Sajedi, Hedieh. "Applications of Data Hiding Techniques in Medical and Healthcare Systems: a Survey." *Applications of Data Hiding Techniques in Medical and Healthcare Systems: a Survey*, SPRINGER NATURE, CAMPUS, 4 CRINAN ST, LONDON, N1 9XW, ENGLAND, Dec. 2018,
apps.webofknowledge.com/full_record.do?product=WOS&search_mode=GeneralSearch&qid=3&SID=F54ANAbQA6CulGlgduE&page=2&doc=55.
- [7] G. Benz, N.V. Paddison, Developing patient-based marketing strategies, *Healthcare Executive* 19 (5) (2004) 40–42.
- [8] D. Fell, C.D. Shepherd, Hospitals and the web: a maturing relationship, *Marketing health Services* 21 (2) (2000) 26–38.

**REPORTS OF THE NATIONAL ACADEMY OF SCIENCES
OF THE REPUBLIC OF KAZAKHSTAN**

ISSN 2224-5227

<https://doi.org/10.32014/2020.2518-1483.126>

Volume 5, Number 333 (2020), 109 – 117

UDC 614:616.9-05(574)

K. O. Alibayeva², B. S. Baiserkin¹, M. K. Saparbekov²

Kazakh scientific center of dermatology and infectious diseases
of the Ministry of health of the Republic of Kazakhstan, Almaty;
Kazakhstan medical University "VSHOZ", Almaty city.

E-mail: karlygash-2303@mail.ru; info@kncdiz.kz; msaparbekov@mail.ru**SCIENTIFIC JUSTIFICATION FOR THE IMPLEMENTATION
OF THE INTEGRATED MODEL OF RAPID TESTING FOR
HIV-INFECTION AMONG KEY POPULATIONS OF KAZAKHSTAN**

Abstract. In the pipeline justify scientifically the approached on the integration of the primary health care and the Service for AIDS prevention and control when rendering services on rapid testing among key populations.

It is noted that methodological basis for integration of the measures in case of HIV-infection with PHC was WHO / UNAIDS strategy "90-90-90", in which it is stated that for effective reaction to and prevention of the spread of HIV infection among key populations, it is recommended to implement an integrated set of measures including diagnosis, treatment and care connected with HIV-infection. It is noted that the integration of primary health care among key populations is carried out within the scope of the statutory free medical assistance (SFMA) and the compulsory health insurance system (CHIS). Rapid testing, pre-and post-test consulting for HIV infection, hepatitis, and STD of key populations when integrating with PHC is carried out in medical organizations, clinics, drop-in centres (DS), people-friendly offices (PFO), NGOs with the involvement of social workers and outreach workers. The integrated activities foresee social support that shall provide access both to medical and psychosocial support services for the key populations.

Keywords: integration, primary health care, service for AIDS prevention and control, key groups, rapid testing for HIV-infection.

Introduction. The growing and the spread of HIV infection in the world are forcing States and the international world community as a whole to form and develop global and national strategies in order to guide and support the integrated response measures on the implementation of the political Declaration of Commitment on HIV/AIDS, the UNAIDS Operating plan for setting national targets on response to the HIV epidemic in a specific region. These obligations of the States were confirmed in the decisions of the high-level meeting of the UN General Assembly on the fight against AIDS, held in New York on 8-10 June 2016. In the light of the need in changes, the new WHO, UNAIDS strategy has committed to stop the AIDS epidemic by 2030 as one of the sustainable development goals. The WHO, UNAIDS strategy for 2016-2021 calls for action according to which:

- by 2020, 90% of people living with HIV will know about their HIV status;
- by 2020, 90% of all patients diagnosed with HIV infection will be provided with antiretroviral therapy;
- by 2020, 90% of all patients receiving antiretroviral therapy will achieve a suppressed viral load [1].

In Kazakhstan, as of January 1, 2020, 36,589 cases of HIV infection were detected, total number of PLHIV - 24,794 people, and the prevalence rate per 100,000 population - 134.8. The highest numbers of PLHIV were registered in Pavlodar, Karaganda, Kostanay regions, in Nur-Sultan and Almaty cities. The International Bank for Reconstruction and development (2015), states that the epidemic caused by HIV-infection in the country is still at a "concentrated" stage, at which the most of new cases of HIV infection is registered among people who use injecting drugs (IDU), men who have sex with men, prisoners, sex workers (SW) and their clients [2]. It is predicted that the share of IDU and MSM in the coming years, in case of maintenance of the current trends in the epidemiological situation in Kazakhstan, will be 67% of

all new cases of HIV infection. In this connection, timely detection of infection and implementation of the methods recommended by WHO and UNAIDS for the prevention, diagnosis and treatment of HIV/AIDS is the main priority direction in the process of implementation of the measures on response to and prevention of the epidemic caused by HIV-infection in Kazakhstan.

Consolidated guideline on HIV infection in key populations: prevention, diagnosis, treatment and care. July 2014 (2015); Work flow chart for HIV prevention in the Republic of Kazakhstan for 2017-2020, taking into account the UNAIDS strategy approved by order of the Ministry of health of the Republic of Kazakhstan No. 164 dated April 14, 2017; materials of the working session "Improvement of HIV/STD testing algorithms in the Republic of Kazakhstan" (2019); collection of the examples of the best practices in public health services in the field of response to and prevention of HIV infection in the WHO European region (2018), new updated WHO, UNEADS documents: Guidelines for self-testing for HIV and informing of partners. December 2016 (2017); updated guidelines on testing for HIV" (2018) [1,2-7], numerous foreign and domestic scientific studies on the problem of implementation of the procedure of rapid testing for HIV infection [8-12] have become a kind of methodological guidelines, informational scientific materials that aim public health professionals to successful making of efforts in the field of organization of preventive measures in case of HIV/AIDS, including rendering of services on rapid testing for HIV among key populations. Published materials of WHO UNAIDS state the need in implementation of the methodology on rapid testing for HIV-infection in Kazakhstan among key populations, non-governmental organizations, and local communities. In the opinion of the world's leading scientists[13,14] it is recognised that rapid testing effectively provides timely access to the necessary information about HIV, routes and prevention measures, as well as treatment and social support, since the knowledge by the key populations of their HIV status is the main component of successful prevention of this infection [15,16]. The authors note that modern rapid blood and saliva tests have high sensitivity and specificity, do not require laboratory equipment, can be performed without need in clinical conditions, and fully meet the modern WHO requirements.

Despite the fact that the implementation of the ideology of rapid testing for HIV infection in the country is an urgent problem of the public health in Kazakhstan, many issues that are connected with rendering of rapid testing services for the key populations have not been sufficiently studied. Thus, primary health care (PHC) institutions are not yet sufficiently integrated into the testing program.

Objective of the study. To justify scientifically the approaches on the integration of the primary health care and the Service for AIDS prevention and control when rendering services on rapid testing for HIV-infection among key populations.

Materials & methods. As the materials of this comprehensive study, we used the results of numerous summarizing works of world-class specialists who are engaged in successful implementation of rapid testing methods in national health systems. In all cases, we were guided by the WHO and UNAIDS recommendation on rapid testing for HIV-infection.

The basic materials that represent this complex work are:

- archival (historical) epidemiological and laboratory data on HIV infection for 1987-2018.;
- results of epidemiological surveillance (ES) of HIV infection among key populations in Kazakhstan for 2014-2018;
- results of validation assessment of quality parameters used in the study of 5 types of rapid blood tests;
- materials of analytical study of the current legislative and normative legal documents regulating rapid testing for HIV infection in Kazakhstan;
- results of a 2-stage sociological study that revealed stigma and discrimination among key populations. In total, 478 respondents were surveyed;
- results of retrospective and prospective analyses of the organization of rapid testing implementation in Kazakhstan among key populations for 2014-2018.;
- results on development of a model of social support for key populations based on NGOs.

When interpreting the epidemiological analysis of the incidence of HIV infection, we used the prevalence indices (prevalence), incidence indices (incidence), recommended by the WHO Committee of experts [17]. Qualitative analysis was used in sociological studies.

The result of the comprehensive study of the possibility of the implementation of rapid testing for HIV infection in Kazakhstan was creation of an integrated model of primary health care and the service for AIDS prevention and control acceptable for the country, in case of rendering of services on rapid testing for HIV infection to key populations.

When forming the idea, strategy, and design of this study, we were guided by the principles of the methodology of scientific research in medicine and healthcare of E. De Puy and L.N. Gitlin (2017) [18]. Statistical analysis of the study results was performed using the Epi info program, version 6.

Results and discussion. Strategic steps on integration of the services with PHC in respect of HIV infection in Kazakhstan were made in accordance with the strategy "Kazakhstan: a new political policy of the established state" (2013) [19]. According to this strategy, within the scope of the long-term modernization of the national health system, it is planned to implement the unified standards of the quality of medical services. In the future, after the adoption of the State program of health care system development «Денсаулық» /"Densaulyk"/ for 2016-2019, the integration of medical services in connection with HIV/AIDS became to develop with a focus on primary health care.

The methodological basis for integration of the preventive measures in case of HIV-infection with PHC was WHO / UNAIDS strategy "90-90-90", in which it is stated that for effective reaction to and prevention of the spread of HIV infection among key populations, it is recommended an integrated set of measures that includes the preventive measures, in particular, rapid testing, treatment and care connected with HIV-infection. WHO emphasizes those services on the integrated set of measures should be: 1) available; 2) acceptable; 3) inexpensive; 4) fair. In addition, WHO recommends to take measures on integration of the services on HIV-infection prevention and treatment among key populations within the scope of relevant specialist services, such as the TB service, the maternal and child health service, the sexual and reproductive health service, and the drug addiction treatment service. The process of integration of PHC institutions into the service for AIDS prevention and control is developed in the works of domestic authors [20-24]. At the same time, it is noted that the development of PHC should be based on three principles: accessibility; universality; social orientation – at the expense of integration of PHC work, social protection and public health services, and active involvement of primary health care professionals in the framework of intersectoral interaction on public health protection [21]. However, Zh.K. Ismailov et al. (2015) notes that the integration of PHC and vertical specialist services (tuberculosis, Oncology, HIV/AIDS, etc.) remains as before insufficient [22]. The authors state that it is necessary to solve the issues of improving the continuity between outpatient-polyclinic and inpatient levels, and the overuse of consulting and diagnostic services persists. The potential of polyclinics and hospitals is not used enough for this purpose, what causes dissatisfaction of the population in the availability and quality of medical services.

Based on the results of the study performed within the scope of the PhD programme, based on the WHO, UNAIDS recommendations, works [20-24,25], the updated orders of the RK Ministry of Health (order of the RK Ministry of Health d/d 04.05.2019, No. KR DSM-2; order of the RK Ministry of Health № KR DSM-128; d/d 27.09.2019; Annex to the order of the RK Ministry of Health d/d May 4, 2019, No KR DSM-62) we prepared the algorithm for the integration model of primary health care and the service for AIDS prevention and control. The integration should be understood to mean: establishing a comprehensive and continuous primary Health care that shall take into account the needs of HIV-positive patients, including patients from key populations, and that shall be based on a patient-oriented approach. Based on the objectives of this work, the key groups (IDU, SW, MSM) are important components of the integrated primary health care in the framework of the system of reaction to and prevention of the epidemic caused by HIV-infection in Kazakhstan. This approach makes it possible to detect HIV infection among key populations at an early stage, ensure timely treatment initiation, and prevent new cases at the expense of treatment and change of patient's behavior. In our opinion, services on rapid testing for HIV infection should be low-threshold, provided free of charge with minimal requirements for the client. It is obviously, that the services to key groups should be accompanied by information campaigns in order to inform the population about the availability of the procedure of rapid testing for HIV infection and the possibility to know easily and quickly about his or her HIV status.

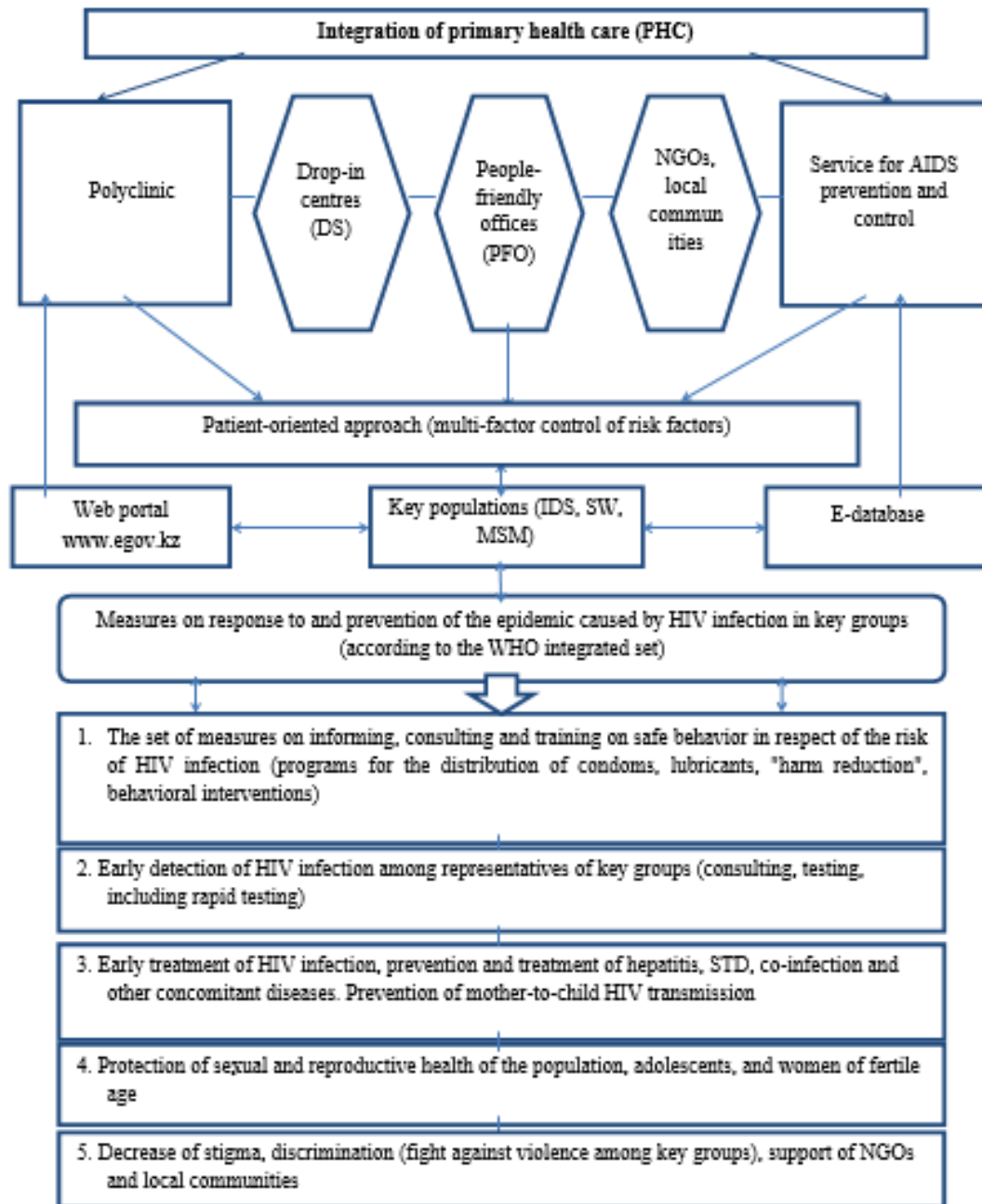

Figure 1 - Algorithm for the integration model of primary health care and the service for AIDS prevention and control

In accordance with this approach, when the key groups are assigned an epidemiologically proven and important role, the following justification is proposed for the integration of PHC institutions and the service for AIDS prevention and control:

1. WHO, UNAIDS recommendation: in terms of its focus the integrated care among key populations in respect of HIV infection should be directed towards health care institutions (primary polyclinics, relevant medical specialized organizations).

2. Positive results of organizing and conducting rapid testing for HIV infection among IDU, SW, MSM, pregnant women, teenagers, and the General population, performed at the medical cluster (AIDS Centers, medical institutions, including clinics) in 16 regions of Kazakhstan during the period of 2014-2018.

3. The presence of the relevant medical organizations in the structure of the integration with PHC that allow to provide to the key groups a wider range of services (the ability to redirect a HIV-positive patient

to specialized medical organizations, conduct high-quality diagnostics, treatment of Hepatitis C virus (HCV), STD, tuberculosis, and drug addiction).

4. Integration with PHC complies with WHO, UNAIDS recommendations: "Treatment of HIV infection-prevention of the epidemic caused by HIV-infection". In the process of the integration the important principle "The strategy of medical care for HIV-infected people is a cascade of treatment" shall be followed, which shall be used for PLHIV, starting from primary diagnosis up to achievement of viral suppression.

Figure 1 shows an algorithm for integration of the primary health care and the service for AIDS prevention and control.

5. Decrease of stigma, discrimination (fight against violence among representatives of key groups). Support and empowerment of NGOs and local communities.

Figure 1 shows that as a result of the integration of PHC institutions and the service for AIDS prevention and control, rendering of comprehensive services will be available to the key groups, including rapid testing, treatment and prevention of HIV infection, hepatitis, and STD.

The organization of integrated measures on HIV / AIDS for key populations, in accordance with the standard of the state service "Voluntary, anonymous and mandatory confidential medical examination" is carried out on an anonymous and confidential basis with the assignment of a unique identification code to each examined person. At this, the activities of the PHC organization in respect of the key populations shall be developed at the place of residence or registration, taking into account the selection of the medical organization.

Rapid testing for HIV, hepatitis, STD is organized and held in the drop-in centres, people-friendly offices and non-governmental organizations that shall provide preventive care and prior- and post-test consulting to the key groups. It should be noted that the integration of PHC and the service for AIDS prevention and control allows for the key groups (IDU, SW, MSM) to receive informational and educational materials, hold a mini-session, discuss the issues connected with HIV infection, Hepatitis virus, STD, behaviors that reduce the risk of infection and receive the reliable information about the need in compliance to ARV therapy.

An important role in the system of integration with PHC is assigned to the patient-oriented approach. We shall note that modern preventive approaches are based on the concept of multi-factor risks. For key populations, in addition to HIV infection, hepatitis, and STD, it is also important to identify other risk factors, such as cardiovascular diseases, cancer, tuberculosis, and diabetes melitus. It is believed that multi-factor control of risk factors can, according to L. Sylla et al (2007), A. I. Vyalkov et al. (2016), ensure an integral effect of decrease of the incidence of the diseases with nosological factors listed above [26, 27].

It is known that primary health care includes three types of care: pre-medical service, qualified medical care, and health and social care that is provided by social workers and psychologists.

The list of the main key components that characterize the model of the integration of PHC and the service for AIDS prevention and control and its continuity is given below:

1. The integration of primary health care in case of HIV infection among key populations is carried out within the scope of the statutory free medical assistance (SFMA) and the compulsory social health insurance system (CHIS).

2. In primary health care institutions and obstetrics services, integration with the service for AIDS prevention and control makes it possible to organize administering medical aid and conduct rapid testing for HIV-infection of pregnant women, including PLHIV and children born by HIV-positive mothers.

3. Integration with PHC enables the service for AIDS prevention and control to take joint HIV/AIDS prevention measures in emergency situations (purchase of rapid tests, ART drugs for carrying out activities in case of emergency situation, etc.).

4. Rapid testing, pre-and post-test consulting for HIV infection, hepatitis, and STD of key populations when integrating with PHC is carried out in drop-in centres, people-friendly offices, NGOs with the involvement of social workers and outreach workers.

5. The integrated activities foresee the program of social support that shall provide access both to medical and psychosocial support services for the key populations.

6. Integration with PHC for HIV/AIDS prevention among the population, including key groups, is provided by specialists of the service for AIDS prevention and control, PHC in collaboration with non-governmental organizations, local communities and public and private relevant organizations.

7. Enhancement of outpatient care for key populations is ensured in cooperation with outpatient-polyclinic, inpatient, palliative and relevant specialized organizations based on the clinical Protocol, in the following specializations: infectious diseases (adult, pediatric), Pediatrics, dermatovenerology, obstetrics, gynecology, Phthisiology, surgery, therapy, Oncology, narcology.

At the present stage, it is important to develop effective methods for evaluation of the integrated programs. Both the overall results (for example, the number and the quantity of services provided to key populations) and specific epidemiological indices (incidence of a disease, mortality, frequency of detection of HIV infection, hepatitis, STD using rapid test method, the degree of testing coverage) are evaluated at this.

We believe that for effective monitoring and evaluation of the effectiveness of individual HIV/AIDS prevention measures for each population of key groups (IDS, SW, MSM), it is reasonable and advisable to develop a system of target indicators in the future. This will allow to evaluate purposefully the preventive measures, monitor the deviations and the results of the implementation of the services provided to key populations.

Conclusion. Integration of the primary health care and the service for AIDS prevention and control opens up additional possibilities for the key populations in Kazakhstan for identification of new cases, treatment and prevention of HIV infection, hepatitis, and STD under the control and monitoring of medical specialists. As part of this approach, the following is important: voluntary, anonymous and / or confidential examinations with the help of free of charge rapid testing, as well as free of charge consulting and treatment of the key populations.

Ethical Approval

This study is approved by the Local Ethics Committee of the Kazakhstan medical University "Higher school of public health" (Protocol No. IRB-A086 dated 29.09.2017).

Conflicts of Interest

The authors declare that there are no conflicts of interest regarding the publication of this paper.

Acknowledgement

The authors express their gratitude to all specialists of the Kazakh scientific center of dermatology and infectious diseases who provided invaluable assistance in carrying out of this study and preparing of this article.

К.О. Алибаева², Б.С. Байсеркин¹, М.К. Сапарбеков²

¹ҚР ДСМ Қазақ дерматология және инфекциялық аурулар ғылыми орталығы, Алматы, Қазақстан;

²«ҚДСЖМ» Қазақстан медициналық университеті, Алматы, Қазақстан

ҚАЗАҚСТАН ХАЛҚЫНЫҢ НЕГІЗГІ ТОПТАРЫ АРАСЫНДА АИТВ-ИНФЕКЦИЯСЫНА ЭКСПРЕСС-ТЕСТІЛЕУДІҢ ИНТЕГРАЦИЯЛАНҒАН МОДЕЛІН ЕНГІЗУДІҢ ҒЫЛЫМИ НЕГІЗДЕМЕСІ

Аннотация. Мәселенің өзектілігі Қазақстан халқының негізгі топтары арасында АИТВ-инфекциясының таралуына негізделген, ол топқа инъекциялық есірткі қолданатындар (ЕК), жыныс қызметкерлері (ЖҚ), ер адаммен жыныстық қатынасқа түсетін ер адам (ЕЖЕ), трансгендер және сотталғандар жатады.

Экспресс-әдістерді пайдалана арқылы АИТВ-инфекциясын уақтылы анықтау елдегі АИТВ-инфекция индетіне қарсы тұратын жүйенің басым бағыты болып саналады.

Зерттеудің мақсаты – халықтың негізгі топтары арасында экспресс-тестілеу қызметтерін ұсыну барысында бастапқы медициналық-санитарлық көмек пен ЖИТС-тың алдын алу және оған қарсы күрес жөніндегі қызметті интеграциялау жөніндегі тәсілдерді ғылыми негіздеу.

Материалдар мен әдістер. Жұмыста тарихи, аналитикалық, эпидемиологиялық, зертханалық, социологиялық, статистикалық әдістер қолданылды. АИТВ-инфекциясына экспресс-тестілеу рәсімі саласындағы әлемнің үздік тәжірибелері талданды. 2030 жылға қарай АИТВ-инфекциясы индетінің таралуын тоқтату жөніндегі жаһандық мақсатты енгізуді ескере отырып, 31 жылдық кезеңдегі Қазақстандағы эпидемиялық үдерістің серпініне бағалау жұмыстары жүргізілді. Үкіметтік емес ұйымдарда АИТВ-инфекциясын тестілеуге байланысты құқықтық және әлеуметтік мәселелер зерделенді. Қазақстанда тіркелген

5 АИТВ-инфекциясына қан бойынша экспресс-тесттің сапа параметрлеріне валидациялық бағалау жұмыстары жүргізілді. Ретроспективті, проспективті талдауларды пайдалана отырып, 2014-2018 жылдары қан мен сілекей бойынша экспресс-тестілерді қолдану арқылы халықтың негізгі топтары (ИЕТ, СЖ, ЕЖЕ) арасында АИТВ-инфекциясына жүргізілген экспресс-тестілеудің нәтижелері бағаланды.

Қазақстанның денсаулық сақтау жүйесіне экспресс-тестілеуді енгізу мүмкіндігін зерделеу бойынша кешенді зерттеулердің қорытындысы халықтың негізгі топтары арасында АИТВ-инфекциясына, гепатиттерге, ЖЖБИ-ге экспресс-тестілеу қызметтерін ұсыну кезінде алғашқы медициналық-санитариялық көмекті (бұдан әрі – АМСК) және ЖИТС-тың алдын алу және оған қарсы күрес жөніндегі қызметті ықпалдастырудың ғылыми негіздемесі болып саналады.

Нәтижелер мен талқылаулар. ДДҰ, ЮНЭЙДС «90-90-90» стратегиясы АИТВ-инфекциясы кезіндегі іс-шараларды АМСК-пен ықпалдастырудың әдіснамалық негізі болып есептеледі, онда халықтың негізгі топтары арасында АИТВ-инфекциясының таралуына тиімді қарсы тұру үшін АИТВ-инфекциясына байланысты диагностика, емдеу мен күтімді қамтитын кешенді шаралар пакетін енгізу ұсынылады. Халықтың негізгі топтары арасында бастапқы медициналық-санитариялық көмекті ықпалдастыру тегін медициналық көмектің кепілдік берілген мөлшері (ТМККК) және міндетті медициналық сақтандыру жүйесі (МӘМС) шеңберінде жүргізілетіні атап өтілді. АМСК-пен ықпалдасу кезінде халықтың негізгі топтарының АИТВ-инфекциясына, гепатиттеріне дейінгі және одан кейінгі тестілік консультация беру, ЖЖБИ-ге экспресс-тестілеу медициналық ұйымдарда, емханаларда, сенім пункттерінде (СП), достық кабинеттерде (ДК), ҰЕҰ-да әлеуметтік қызметкерлер мен аутич-қызметкерлерді тарта отырып жүргізіледі. Интеграцияланған іс-шаралар халықтың негізгі топтарының медициналық және психоәлеуметтік қолдау қызметтеріне қолжетімділігін жақсартуды қамтамасыз ететін әлеуметтік сүйемелдеуді көздейді.

Қорытынды. Алғашқы медициналық-санитариялық көмек пен ЖИТС-тың алдын алу және оған қарсы күрес жөніндегі қызмет интеграциясы медицина мамандарының бақылау және мониторингі арқылы жаңа жағдайды анықтау, АИТВ-инфекциясын, гепатиттерді, ЖЖБИ емдеу және алдын алу кезінде Қазақстан халқының негізгі топтарына қосымша мүмкіндіктер ашады.

Мұндай тәсіл шеңберінде ерікті, жасырын және (немесе) құпия тексеру, оның ішінде халықтың негізгі топтарын тегін негізде экспресс-тестілеу маңызды мәнге ие. Жұмыста халықтың негізгі топтары арасында экспресс-тестілеу қызметін ұсыну кезінде бастапқы медициналық-санитарлық көмек пен ЖИТС-тың алдын алу және оған қарсы күрес жөніндегі қызметті интеграциялау жөніндегі тәсілдерді ғылыми негіздеген.

Түйін сөздер: интеграция, алғашқы медициналық-санитариялық көмек, ЖИТС-тың алдын алу және оған қарсы күрес қызметі, негізгі топтар, АИТВ-ға экспресс-тестілеу.

К.О. Алибаева², Б.С. Байсеркин¹, М.К. Сапарбеков²

¹Казахский научный центр дерматологии и инфекционных заболеваний МЗ РК, Алматы.

²Казахстанский медицинский университет «ВШОЗ», Алматы

НАУЧНОЕ ОБОСНОВАНИЕ ВНЕДРЕНИЯ ИНТЕГРИРОВАННОЙ МОДЕЛИ ЭКСПРЕСС-ТЕСТИРОВАНИЯ НА ВИЧ-ИНФЕКЦИЮ СРЕДИ КЛЮЧЕВЫХ ГРУПП НАСЕЛЕНИЯ КАЗАХСТАНА

Аннотация. Актуальность проблемы обусловлена распространением ВИЧ-инфекции среди ключевых групп населения Казахстана, к которым относятся люди, употребляющие инъекционные наркотики (ЛУИН), работники секса (РС), мужчины имеющие секс с мужчинами (МСМ), трансгендеры, осужденные.

Своевременное выявление ВИЧ-инфекции с использованием экспресс-методов является приоритетным направлением системы противодействия эпидемии ВИЧ-инфекции в стране.

Цель исследования: научно обосновать подходы по интеграции первичной медико-санитарной помощи и службы по профилактике и борьбе со СПИД при предоставлении услуг по экспресс-тестированию среди ключевых групп населения.

Материалы и методы. В работе использовались исторические, аналитические, эпидемиологические, лабораторные, социологические, статистические методы. Проанализированы лучшие практики мира в сфере процедуры экспресс-тестирования на ВИЧ-инфекцию. Проведена оценка динамики эпидемического процесса в Казахстане за 31-летний период с учетом внедрения Глобальных целей по прекращению распространения эпидемии ВИЧ-инфекции к 2030 году. Изучены правовые и социальные проблемы, связанные с тестированием на ВИЧ-инфекцию в неправительственных организациях. Проведена валидационная оценка параметров качества 5 зарегистрированных в Казахстане экспресс-тестов на ВИЧ-инфекцию по крови. С использованием ретроспективного, проспективного анализов оценены результаты проведенного экспресс-тестирования на ВИЧ-инфекцию среди ключевых групп населения (ЛУИН, РС, МСМ) с применением экспресс-тестов по крови и слюне за 2014-2018 годы.

Итогом комплексных исследований по изучению возможности внедрения экспресс-тестирования в систему здравоохранения Казахстана явилось научное обоснование интеграции первичной медико-санитарной помощи (далее ПМСП) и службы по профилактике и борьбе со СПИД при предоставлении услуг по экспресс-тестированию на ВИЧ-инфекцию, гепатиты, ИППП среди ключевых групп населения.

Результаты и обсуждения. Методологической основой интеграции мероприятий при ВИЧ-инфекции с ПМСП явилась стратегия ВОЗ, ЮНЭЙДС «90-90-90», в которой отмечено, что для эффективного противодействия распространению ВИЧ-инфекции среди ключевых групп населения рекомендуется внедрять комплексный пакет мер, включающий диагностику, лечение и уход в связи с ВИЧ-инфекцией. Отмечено, что интеграция первичной медико-санитарной помощи среди ключевых групп населения проводится в рамках гарантированного объема бесплатной медицинской помощи (ГОБМП) и системы обязательного медицинского страхования (ОСМС). Экспресс-тестирование, до- и после-тестовое консультирование на ВИЧ-инфекцию, гепатиты, ИППП ключевых групп населения при интеграции с ПМСП проводятся в медицинских организациях, в поликлиниках, пунктах доверия (ПД), дружественных кабинетах (ДК), НПО с привлечением социальных работников и аутрич-работников. Интегрированные мероприятия предусматривают социальное сопровождение, обеспечивающее улучшение доступа ключевых групп населения как к медицинским, так и услугами психосоциальной поддержки.

Вывод. Интеграция первичной медико-санитарной помощи и службы по профилактике и борьбе со СПИД открывает дополнительные возможности для ключевых групп населения Казахстана при выявлении новых случаев, лечения и профилактики ВИЧ-инфекции, гепатитов, ИППП под контролем и мониторингом медицинских специалистов.

В рамках такого подхода важное значение имеет добровольное, анонимное и (или) конфиденциальное обследование, в том числе экспресс-тестирование ключевых групп населения на бесплатной основе.

Ключевые слова: интеграция, первичная медико-санитарная помощь, служба по профилактике и борьбе со СПИД, ключевые группы, экспресс-тестирование на ВИЧ.

Information about author:

Alibayeva K.O., PhD student, Kazakhstan School of public Health, Almaty, Kazakhstan, karlygash-2303@mail.ru; <https://orcid.org/0000-0002-5803-7012>;

Baiserkina B.S., Doctor of medical sciences, Director of Kazakh scientific center of dermatology and infectious diseases of the Ministry of health of the Republic of Kazakhstan, Almaty; info@kncdiz.kz; <https://orcid.org/0000-0001-9702-3951>;

Saparbekov M.K., Doctor of medical sciences, professor, Kazakhstan School of public Health, Almaty, Kazakhstan; msaparbekov@mail.ru; <https://orcid.org/0000-0003-4101-572X>

REFERENCES

- [1] “90-90-90” Ambitions treatment targets: writing the final Chapter of the AIDS epidemic a discussion paper”, Geneva, Joint United Nations Program on HIV/AIDS, 2014, <http://www.unaids.org/en/resources/documents/2014/90-90-90>, accessed 3 March, 2015.
- [2] Optimizing Investments in Kazakhstan's HIV Response. The World Bank 1818 Street NW, Washington DC 2043. 2015-62p., <http://www.worldbank.org>.
- [3] Roadmap for the prevention of HIV infection in the Republic of Kazakhstan for 2017-2020, taking into account the UNAIDS strategy, approved by the Order of the Ministry of Health of the Republic of Kazakhstan No. 164 dated April 14, 2017.
- [4] Workshop “Improving algorithms for HIV/STD’s testing in the Republic of Kazakhstan // Astana, April 27, 2019. 59 p.
- [5] A collection of best health practices on the protection against HIV infection in the European Region // WHO, Copenhagen, 2018. 169 p. (translated from English).
- [6] Guidelines for HIV Self-Testing and Partner Informing. Supplement to the Consolidated Guidelines for HIV Testing Services. December 2016 // WHO. 2018. 82p. (translated from English), <http://creativecommons.org/licenses/by-nc-sa/3.0/the>.
- [7] Ball E., Baggaly R., Johnson S. and others. Updated guidelines for HIV testing//Mater. “HIV/AIDS Conferences in Eastern Europe and Central Asia, WHO, April 18-20, 2018, Switzerland (translated from English) # test 4 HIV www.org.rus.
- [8] Wilton J. The State of HIV testing in Canada: A systematic review//CATIE-Canada’s source for HIV and hepatitis C information. Spring 2015, <http://www.catie.ca/en/pif/spring-2015/rapid-point-care-hiv-testing-review-evidence>.
- [9] Lau L., Wudel B., Lee E et al Evaluation on the Utility of Point – Coore HIV Testing on a Canadian Internal Medicine inpatient Unit//Canadian Journal of infection Diseases and Medical Microbiology, Volume, 2017. 6 p., <http://doi.org/10.1155/2017/8495307>
- [10]WHO. HIV Rapid diagnostics for Self-Testing. 3rd Edition, http://Unaited.en/assets/HIV-Rapid Tests-for Self-Testing – Landcape - Report-3rd Edition-July-2017.pdf
- [11]Nugmanova Zh.S., Baisserkin B.S., Kassymbekova S.Zh. The use of express (rapid) tests to diagnose some socially significant infections (HIV infection, viral hepatitis C, syphilis). Tutorial. Almaty, 2019. 85 p.
- [12]Curtin M.E., Gvetadze R., Leelawiwat W et al. Analysis of False – Negative Human Immunodeficiency Virus Rapid Tests Perfomed on Oral Fluid in 3 International Clinical Research Studies. Clin. Infect. Dis. 2017; 64 (12): 1663.
- [13]Melo M.C.B., Ximenes R.A.A., Falcao I.V., Miranda – Filho D.B. Does rapid HIV Testing result in an early diagnosis and reduce the waiting time for patients to receive medical care? AIDS. Care, 2018.Jan. 30(1): 40-46.

- [14]Shanks L. Siddiqui M., Kliescikova J et. al. Evaluation of HIV Testing algorithm and weakly reacting test lines in contributing to a high rates of false positive HIV diagnoses //BMC Infection, 2015. V. 15, 3 February, P.1-10.
- [15]Kufa T., Lane T., Manyuchi A. et al. The accuracy of HIV rapid testing in integrated bio – behavioral surveys of men who have sex with men accrose in South Africa. *Medicine (Baltimore)*, 2017 Jul; 96 (28): e 739, doi: 10. 1097/MD
- [16]Saparbekov M.K. *Epidemiology and research methods: tutorial*. Ed. “RISSO” Al-Farabi Kazakh National University, Almaty, 2016. 170 p.
- [17]Elisabeth De Poi, Laura N. Gitlin. *Scientific research methods in medicine and healthcare* / Edited by V.V. Vlassova. M.: Geotar - Media, 2017. 432 p. (translated from English).
- [18]“Kazakhstan - 2050” Strategy: New political course of the established state. Message from the President of the Republic of Kazakhstan - Leader of the Nation Nursultan Nazarbayev to the people of Kazakhstan on December 14, 2012. Taldykorgan, 2013. 62 p.
- [19]Tukeyev M.S., Battakova Zh.Y., Abishev A.T. and others. *Prevention of HIV infection in primary health care (guidelines)*. Almaty, 2014. 52 p.
- [20]Baygenzhin A.K., Ismailov Zh.K., Akhmetniyazova L.M., Issatayeva N.M. Prospects for the development of the health care system of the Republic of Kazakhstan//*Health Manager of the Republic of Kazakhstan*. 2015. No. 4 (17). 12-16 p.
- [21]Ismailov Zh.K., Syzdykova A.A., Issatayeva N.M., Baiserkin B.S., Tlemissova V.B. The current health care system of the Republic of Kazakhstan//*Health Manager of the Republic of Kazakhstan*. 2015. No. 4 (17). 17-24 p.
- [22]Baiserkin B.S. The urgency of the HIV infection problem in the Republic of Kazakhstan. *KZ Health Academy*. 2016. 4-9 p., www.academzdrav.kz.
- [23]Aringazina A.M., Yessimov N.V., Ismailova N.T. Integration of primary health care and services for the prevention and control of HIV/AIDS//*Vestnik of KazNMU*, 2019. No.1 532. 536 p.
- [24]Nugmanova Zh.S. New approaches to the prevention of HIV infection (literature review)//*Vestnik of KazMNU*. 2018. No. 2. 40-42 p.
- [25]Sylla L. Bruce R.D., Kamarulzaman and others. Integration and territorial associations of services for the treatment of HIV infection, tuberculosis and drug addiction treatment// *International journal on drug policy*, 2007. 28-35 p. (translated from English).
- [26]Vyalkov A.I., Gundarov N.A., Polesskiy V.A. Personalized prevention in primary health care: rationale, organizational and functional model, innovative technologies//*Head physician, Monthly scientific and practical journal*, 2016. No. 5. 6-23 p.

U.N. Kapysheva, Sh.K. Bakhtiyarova, A.K. Baimbetova

RSE at the BEC "Institute of Human and Animal Physiology" SC MES RK, Almaty, Kazakhstan.
e-mail: unzira@inbox.ru, bifara.66@mail.ru, baimbetova53@mail.ru

REMOTE CONSEQUENCES OF PESTICIDE POLLUTION ON THE LEVEL OF DEVELOPMENT OF COGNITIVE FUNCTIONS

Abstract. The purpose of this study is to identify the characteristics of the state of short-term memory, sustainability and concentration of attention among rural residents living in places of long-term pesticidal pollution. The study of cognitive functions in residents was performed using the special Neurosoft computer base program. A significant decrease (by 20%) in the number of people with a high level of development of short-term memory by numbers and images was revealed. An increase of 18% in the number of people with poorly developed cognitive abilities is shown both when remembering information on numbers and images, as well as when concentration and stability of attention is on the desired object. At the same time, the memory capacity of residents with a high level of development of the function of memorizing information, both for numbers and images, was at the same level as the benchmarks and ranged from 61% to 67% of the amount of information proposed for memorization. The study showed that living in a zone of long-term pesticidal pollution worsens cognitive functions - memory and attention, upsets the balance of the main nervous processes - excitation and inhibition, and increases the risk of developing nervous disorders.

Keywords: pesticides, pollution, living environment, human health, cognitive functions.

Introduction. Most pesticides used are to varying degrees toxic to humans and warm-blooded animals. Pesticides accumulate in the liver, kidneys and heart, bind to blood proteins and are carried throughout the body, metabolized and excreted at different rates from the body. Many studies have shown that pesticides have a mutagenic, carcinogenic and toxic effect, directly or indirectly inhibiting the nervous system of a living organism [1,2]. Pesticide metabolites have the ability to accumulate, especially in the adipose tissue of a living organism and slowly destroy the cells of the mucous membranes, tissues, organs, disrupting the interaction and functions of internal organs. As a result, the level of public health is falling, the incidence of blood, digestive organs, mental and endocrine disorders, as well as cancer pathologies is growing [3-5].

On the territory of Kazakhstan, there is the problem of the disposal of obsolete and disposable pesticides widely used in the Union, in particular, dust - DDT. According to various estimates, pesticides belonging to the group of persistent organic pollutants (POPs pesticides), mainly DDT, make up 10-15% of all stored obsolete pesticides. The potential and real environmental and toxicological hazard of such pesticides remains quite high [6]. Directly on the territory of the Talgar region near the city of Almaty, the population of which we examined, pollution of abandoned storage facilities with organochlorine pesticides (metabolites 2,4 DDD, 4,4 DDT, 4,4 DDE and isomers of α -HCH, β -HCH and γ -HCH), the concentrations of which are significantly higher than the MPC, the presence of obsolete and unusable pesticides in warehouses was revealed [7]. It should also be taken into account that the territory adjacent to the storage sites of unused pesticides has a high level of pollution and has long been a source of secondary environmental pollution with pesticides [8].

The purpose of this study is to identify the characteristics of the state of short-term memory, sustainability and concentration of attention among rural residents living in places of long-term pesticidal pollution.

Object and research methods. The control group consisted of 102 residents of 2 villages of the Almaty region located in and near the Altyn Emel nature reserve. This is 54 residents. Basshee and 48 inhabitants with. Taukaraturyk of Almaty region. The experimental group included 149 residents aged 20 to 70 years, living the last 10 years on the ground or in the immediate vicinity of the former pesticidal storage facilities and warehouses of the Almaty region (date from 2018 and 2019). These are residents from. Beskainar (44 people), Kyzylkairat (41 people), Belbulak (43 people) and s. Amangeldy (21 people - brigade 1 and 2).

To identify the state of cognitive functions, the amount of short-term memory was determined by numbers, images, stability and concentration. At the same time, the number of correct answers, the number of errors, the search time for numbers or an image, the amount of memory, as well as the accuracy of reproduction were taken into account. Depending on the accuracy of the responses, a high, medium, and low level of reproduction was determined. For this, tests were used according to the basic program of a computer complex for psychophysiological testing NS-PsychoTest Neurosoft LLC Russia, 2012 [9, 10].

The results were statistically processed using the Microsoft Excel program, while M is the arithmetic mean, SD is the standard deviation, m is the standard error of the arithmetic mean. Data processing was carried out taking into account the unpaired Fisher-Student test and was considered reliable at $p \leq 0.05$.

In human studies, they were guided by the decision of the LEC of the Kazakh-Russian Medical University (KRMU), protocol No. 52 of September 5, 2017.

Research results. Cognitive functions are the most complex functions of the brain, which include memory, attention, reaction speed, the ability to assimilate and preserve skills [11]. In chronic pesticide poisoning in humans, various functional and dynamic cognitive impairment is often noted - a decrease in memory, instability of attention, and a low reaction rate [4, 5]. A study of the cognitive sphere of the brain activity of residents of rural settlements living in places especially contaminated with pesticides showed the following.

Control group. In the test “Memory for numbers”, more than half (55.61%) of the respondents showed a high level of reproduction of numbers with memorization of 62.55% of numerical information. In the test “Memory for images”, more than 51.80% of respondents showed a high level of reproduction of images in short-term memory and memorized 70.40% of information in the form of images (figure 1, 2). Introduction Most pesticides used are to varying degrees toxic to humans and warm-blooded animals. Pesticides accumulate in the liver, kidneys and heart, bind to blood proteins and are carried throughout the body, metabolized and excreted at different rates from the body. Many studies have shown that pesticides have a mutagenic, carcinogenic and toxic effect, directly or indirectly inhibiting the nervous system of a living organism [1,2]. Pesticide metabolites have the ability to accumulate, especially in the adipose tissue of a living organism and slowly destroy the cells of the mucous membranes, tissues, organs, disrupting the interaction and functions of internal organs. As a result, the level of public health is falling, the incidence of blood, digestive organs, mental and endocrine disorders, as well as cancer pathologies is growing [3-5].

On the territory of Kazakhstan, there is the problem of the disposal of obsolete and disposable pesticides widely used in the Union, in particular, dust - DDT. According to various estimates, pesticides belonging to the group of persistent organic pollutants (POPs pesticides), mainly DDT, make up 10-15% of all stored obsolete pesticides. The potential and real environmental and toxicological hazard of such pesticides remains quite high [6]. Directly on the territory of the Talgar region near the city of Almaty, the population of which we examined, pollution of abandoned storage facilities with organochlorine pesticides (metabolites 2,4 DDD, 4,4 DDT, 4,4 DDE and isomers of α -HCH, β -HCH and γ -HCH), the concentrations of which are significantly higher than the MPC, the presence of obsolete and unusable pesticides in warehouses was revealed [7]. It should also be taken into account that the territory adjacent to the storage sites of unused pesticides has a high level of pollution and has long been a source of secondary environmental pollution with pesticides [8].

The purpose of this study is to identify the characteristics of the state of short-term memory, sustainability and concentration of attention among rural residents living in places of long-term pesticidal pollution.

Object and research methods. The control group consisted of 102 residents of 2 villages of the Almaty region located in and near the Altyn Emel nature reserve. This is 54 residents. Basshee and 48 inhabitants with. Taukaraturyk of Almaty region. The experimental group included 149 residents aged 20 to 70 years, living the last 10 years on the ground or in the immediate vicinity of the former pesticidal storage facilities and warehouses of the Almaty region (date from 2018 and 2019). These are residents from. Beskainar (44 people), Kyzylkairat (41 people), Belbulak (43 people) and s. Amangeldy (21 people - brigade 1 and 2).

To identify the state of cognitive functions, the amount of short-term memory was determined by numbers, images, stability and concentration. At the same time, the number of correct answers, the number of errors, the search time for numbers or an image, the amount of memory, as well as the accuracy of reproduction were taken into account. Depending on the accuracy of the responses, a high, medium, and low level of reproduction was determined. For this, tests were used according to the basic program of a computer complex for psychophysiological testing NS-PsychoTest Neurosoft LLC Russia, 2012 [9, 10].

The results were statistically processed using the Microsoft Excel program, while M is the arithmetic mean, SD is the standard deviation, m is the standard error of the arithmetic mean. Data processing was carried out taking into account the unpaired Fisher-Student test and was considered reliable at $p \leq 0.05$.

In human studies, they were guided by the decision of the LEC of the Kazakh-Russian Medical University (KRMU), protocol No. 52 of September 5, 2017.

Research results. Cognitive functions are the most complex functions of the brain, which include memory, attention, reaction speed, the ability to assimilate and preserve skills [11]. In chronic pesticide poisoning in humans, various functional and dynamic cognitive impairment is often noted - a decrease in memory, instability of attention, and a low reaction rate [4,5]. A study of the cognitive sphere of the brain activity of residents of rural settlements living in places especially contaminated with pesticides showed the following.

Control group. In the test “Memory for numbers”, more than half (55.61%) of the respondents showed a high level of reproduction of numbers with memorization of 62.55% of numerical information. In the test “Memory for images”, more than 51.80% of respondents showed a high level of reproduction of images in short-term memory and memorized 70.40% of information in the form of images (figure 1, 2).

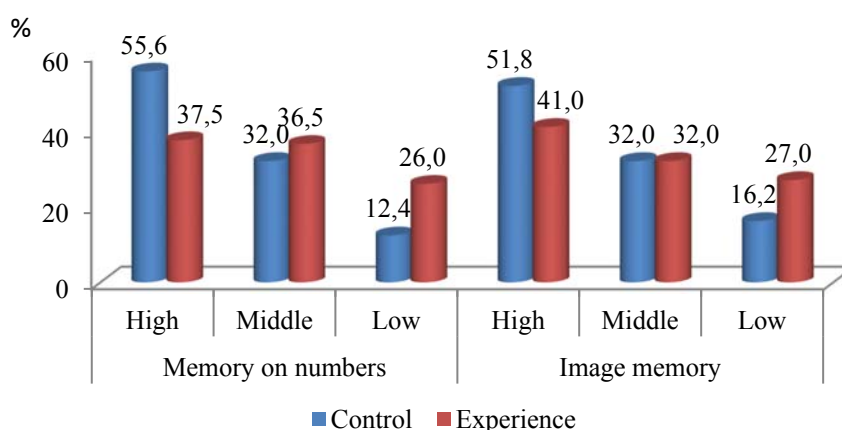

Figure 1 - The number of respondents in the control and experimental groups (%) with different levels of development of short-term memory

More than a third of participants (35-36%) showed an average level of memorization of information - the amount of memorization of numerical information ranged from 42.10%, images - 39.6%. The remaining respondents (28%) when memorizing both numerical and figurative information showed a minimum level of memorizing information, ranging from 18 to 20% (figure 2).

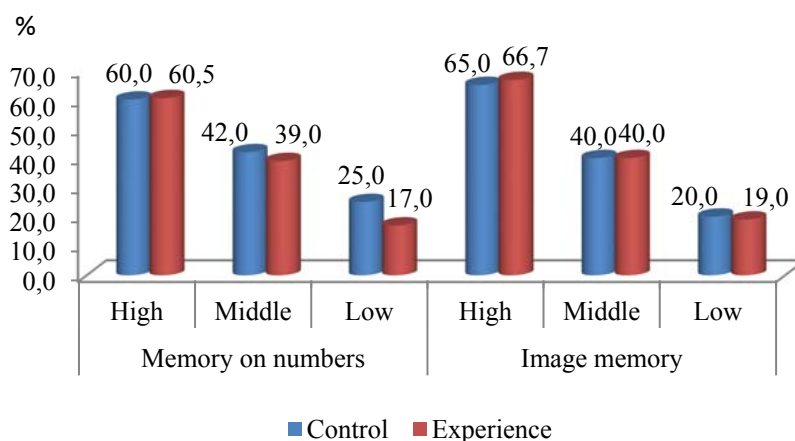

Figure 2 - The volume of memorized information (%) among the respondents in the control and experimental groups in the tests “Memory for numbers” and “Memory for images”

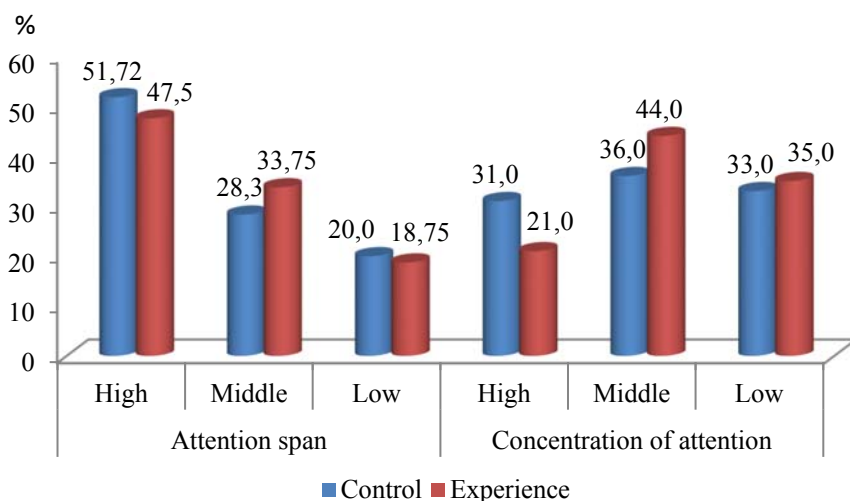

Figure 3 - Stability and concentration of attention (%) among respondents in the control and experimental groups in the test “Attention Assessment”

Experienced group. The number of test participants with a high level of memory development for numbers and images amounted to 37.50% of the total number (figure 1). The amount of information they memorized was 60.54% for numbers and 66.77% for images (figure 2). The number of people with an average level of development of short-term memory ranged from 34 to 35% - for numbers and images, with a memory volume of 30 to 40% of the total amount of information. The remaining respondents, comprising from 28 to 29% of the total number of respondents in the experimental group, showed a low level of memory development both in numbers and in remembering images. Moreover, the amount of information they memorized ranged from 17% to 19% (figure 1.2).

A comparative assessment of the state of cognitive functions among participants in the experimental and control groups showed that the number of people with a high level of information reproduction on numbers and images living in places of pesticidal pollution is significantly (20%) less than in the control group. Nevertheless, the amount of memorized information in people with a high level of memory development was at the same level in both the experimental and control groups. Accordingly, the number of people with a low level of memory development in the experimental group was significantly larger compared to the control data. At the same time, the volume of memorized information in both groups did not exceed 20% level.

An objective assessment of attention as one of the main characteristics of a person's cognitive functions includes the state of concentration (concentration) and absent-mindedness, mobility, and stability of this reaction when presenting various kinds of objects, which plays a leading role in human life [12]. A high level of attention stability was shown by more than half (51.72%) of the residents of the control group, but only 31% showed the ability to concentrate, the rest of the subjects were divided between medium (from 30% to 36%) and low (from 20 to 33%) , respectively, stability and concentration (figure 3).

In the experimental group of respondents with a high level of attention stability, less than half of the participants (47.5%) were identified, and only 21% of the total number were able to concentrate. The remaining respondents were distributed at an average level (from 33 to 43% of participants) and at a low level, their number was from 18.75% in terms of attention stability and 35% in terms of concentration. As can be seen from the data presented, the number of respondents from the experimental group with a high level of stability and concentration of attention is 10% less than in the control group. The number of people with a low level of ability to concentrate and sustain attention in the experimental group reaches 35% of the total number examined, the number of respondents with an average level of 44% and above.

The results of a study of the main cognitive functions of rural residents living in places of non-utilized pesticidal storages and depots showed that the number of people with a high level of development of short-term memory is 20% less, while with a low level of information storage, it is 18% more than in the control population. At the same time, the memory capacity of respondents with a high level of development of the function of memorizing information, both for numbers and images, was at the same level as the control data (from 61% to 67%). When assessing attention as one of the main indicators of cognitive functions, a decrease of 5% and 10% in the number of persons in the experimental group with highly developed ability to concentrate and sustain attention was revealed, compared with the data in the control group. Both memory and attention assessment showed a decrease in the number of individuals with a high level of development of cognitive functions living in places of pesticidal pollution. An increase in the number of persons with poorly developed opportunities for memorization, concentration and stability of attention, reflecting the main properties of the nervous system - excitation and inhibition in the central nervous system, was also noted.

Human health is a reliable indicator of the ecological well-being of the environment. With pesticidal contamination, prerequisites appear for increasing the incidence of, primarily, the respiratory system and disorders of the nervous system, directly cognitive functions [13]. Recent studies show the negative impact of pesticidal pollution on the nervous system, are characterized by a neurotoxic and psychotropic effect caused by direct or indirect effects on M- or N-cholinergic receptors, which leads to an increase in diseases in children with attention deficit hyperactivity disorder [14].

On the territory of the Talgar district of the Almaty region to date, there are 64 destroyed storages of insecticides and herbicides, the metabolic products of which regularly pollute the environment, accumulate in vegetables and fruits, water and plants serving as animal feed [15]. Long-term residence in these places led to an increase in the number of people (up to 30%) with a low level of development of memory and attention, the amount of memorization of information which does not exceed 1/5 of the proposed level.

Conclusion: Living in a zone of perennial pesticidal pollution is one of the factors that worsen cognitive functions - memory and attention, upsets the balance of the main nervous processes – excitation and inhibition, and increases the risk of developing nervous disorders.

The study was carried out as part of the implementation of the scientific and technical program No. BR05236379 "Comprehensive assessment of the impact of unused and prohibited pesticides on the genetic status and health of the population of Almaty region."

У.Н. Капышева, Ш.Қ. Бахтиярова, А.К. Баимбетова

ҚР БҒМ ҒК «Адам және жанауарлар физиологиясы» институты РМҚ

ПЕСТИЦИДТІК ЛАСТАНУДЫҢ ТАНЫМДЫҚ ФУНКЦИЯЛАРДЫҢ ДАМУ ДЕҢГЕЙІНЕ ҰЗАҚМЕРЗІМДІ ӘСЕРІ

Аннотация. Зерттеудің мақсаты – ұзақмерзімді пестицидтермен ластанған жерде тұратын ауыл тұрғындарының қысқамерзімді есте сақтау күйінің, тұрақтылығы мен назарының шоғырлануын анықтау. Резиденттердегі танымдық функцияларды зерттеу арнайы Neurosoft компьютерлік база бағдарламасы арқылы жүргізілді. Сан мен суреттер бойынша қысқамерзімді есте сақтау қабілеті жоғары адамдардың айтарлықтай төмендегені (20%-ға) байқалды. Танымдық қабілеті нашар дамыған адамдардың 18%-ға артуы сан мен суреттер туралы ақпаратты есте сақтау кезінде де, зейіннің шоғырлануы мен тұрақтылығы барысында да байқалады. Сонымен қатар, сан мен суреттер бойынша да ақпаратты сақтау функциясының даму деңгейі тұрғындардың жоғары есте сақтау қабілеті көрсеткіштерімен деңгейлес және сақтау үшін ұсынылған ақпарат көлемі 61%-дан 67%-ға дейінгі аралықты көрсетті. Зерттеу көрсеткендей, ұзақмерзімді пестицидтік ластану аймағында өмір сүру танымдық функцияларды – есте сақтау мен назарды шоғырландыру жағдайын нашарлатады, негізгі жүйке үдерістерінің – козу мен тежелудің тепе-теңдігін бұзады, жүйке бұзылыстарының даму қаупін арттырады.

Пайдаланылатын пестицидтердің көпшілігі әртүрлі дәрежеде адамдарға және жылықанды жануарларға улы болып келеді. Пестицидтер бауырда, бүйректе және жүректе жинақталады, қан протеиндерімен байланысады және бүкіл денеде жүреді, әртүрлі мөлшерде метаболизденеді және организмнен шығарылады. Көптеген зерттеулер пестицидтер тірі организмнің жүйке жүйесін тікелей немесе жанама түрде төмендететін мутагендік, канцерогендік және уытты әсерге ие екендігін көрсетті. Пестицид метаболиттері, әсіресе тірі ағзаның жабысқақ тінінде жиналып, шырышты қабықтардың, ұлпалардың, ағзалардың жасушаларын баяу бұзады, ішкі ағзалардың өзара әрекеті мен функцияларын бұзады. Нәтижесінде халықтың денсаулығының деңгейі төмендейді, қанның, ас қорыту органдарының, психикалық және эндокриндік аурулардың, сондай-ақ онкологиялық патология төмендейді.

Қазақстан аумағында Одақта кеңінен қолданылатын ескірген және жойылатын пестицидтерді көму мәселесі кездеседі, атап айтқанда, тозаң – ДДТ. Түрлі бағалауға сәйкес, тұрақты органикалық ластағыштар тобына жататын пестицидтер (ТОЛ (тұрақты органикалық ластағыш) пестицидтер), негізінен ДДТ, барлық ескірген пестицидтердің 10-15% құрайды. Мұндай пестицидтердің ықтимал және нақты экологиялық және токсикологиялық қауіптілігі айтарлықтай жоғары. Біз қарастырған Алматы қаласы маңындағы Талғар ауданының аумағында, қараусыз қалған қоймалар органохлорлы пестицидтермен (метаболиттер 2,4 ДДД, 4,4 ДДТ, 4,4 ДДЕ және α -ГХЦП, β -ГХЦП және γ -ГХЦП изомерлерімен) ластанғаны анықталды, концентрациясы ШРК-ден едәуір асатын, қоймаларда ескірген және пайдалануға жарамсыз пестицидтердің болатыны анықталды. Пайдаланылмаған пестицидтер сақталатын қоймаға жақын орналасқан аумақтың ластану деңгейі жоғары және ұзақ уақыт қоршаған ортаны пестицидтермен ластанудың көзі болып саналады.

Түйін сөздер: пестицидтер, ластану, қоршаған орта, адам денсаулығы, таным қызметі.

У.Н. Капышева, Ш.К. Бахтиярова, А.К. Баимбетова

РГП на ПХВ «Институт физиология человека и животных» КН МОН РК

ОТДАЛЕННЫЕ ПОСЛЕДСТВИЯ ПЕСТИЦИДНОГО ЗАГРЯЗНЕНИЯ НА УРОВЕНЬ РАЗВИТИЯ КОГНИТИВНЫХ ФУНКЦИЙ

Аннотация. Цель данного исследования – выявить особенности состояния краткосрочной памяти, устойчивости и концентрации внимания у жителей сельской местности, проживающих в местах многолетнего пестицидного загрязнения. Исследование когнитивных функций у жителей проводили с использованием специальной компьютерной базовой программы «Нейрософт». Выявлено значительное уменьшение (на 20%) числа людей с высоким уровнем развития краткосрочной памяти на числа и образы. Показан рост на 18% числа людей со слабо развитыми когнитивными способностями как при запоминании информации на числа и образы, а также при концентрации и устойчивости внимания на требуемом объекте. При этом объем памяти у жителей с высоким уровнем развития функции запоминания информации как на числа, так и на образы был на одном уровне с контрольными показателями и составлял от 61% до 67% от объема предлагаемой к запоминанию информации. Исследование показало, что проживание человека в зоне многолетнего пестицидного загрязнения ухудшает когнитивные функции – память и внимание, нарушает баланс основных нервных процессов – возбуждения и торможения, увеличивает риск развития нервных расстройств.

Большинство применяемых пестицидов в разной степени токсично для человека и теплокровных животных. Пестициды накапливаются в печени, почках и сердце, связываются с белками крови и разносятся по организму, подвергаются метаболизму и выводятся с разной скоростью из организма. Во многих исследованиях показано, что пестициды обладают мутагенным, канцерогенным и токсическим эффектом, прямо или косвенно угнетающим нервную систему живого организма. Метаболиты пестицидов обладают свойством накапливаться, особенно в жировой ткани живого организма и медленно разрушают клетки слизистых оболочек, ткани, органы, нарушая взаимодействие и функции внутренних органов. В результате этого падает уровень здоровья населения, растет заболеваемость крови, органов пищеварения, психических и эндокринных расстройств, а также онкологических патологий.

На территории Казахстана существует проблема захоронения устаревших и подлежащих утилизации ядохимикатов, широко применяемых при Союзе, в частности дуста – ДДТ. По различным оценкам, пестициды, относящиеся к группе стойких органических загрязнителей (СОЗ-пестициды), преимущественно ДДТ, составляют 10-15 % от всех хранящихся устаревших пестицидов. Потенциальная и реальная эколого-токсикологическая опасность таких пестицидов остается достаточно высокой. Непосредственно на территории Талгарского района близ г. Алматы, население которого было нами обследовано, установлено загрязнение заброшенных хранилищ хлорорганическими пестицидами (метаболитами 2,4 ДДД, 4,4 ДДТ, 4,4 ДДЭ и изомерами α -ГХЦГ, β -ГХЦГ и γ -ГХЦГ), концентрации которых значительно превышают ПДК, на складах выявлено наличие устаревших и непригодных к применению пестицидов. Необходимо также учитывать, что территория, прилегающая к местам складирования неиспользованных пестицидов, имеет высокий уровень загрязнения и долгое время служит источником вторичного загрязнения окружающей среды пестицидами.

Ключевые слова: пестициды, загрязнение, среда проживания, здоровье человека, когнитивные функции.

Information about authors:

Kapysheva U. N., Doctor of Biological Sciences, Professor. RSE at the Institute of Physiology of Man and Animals at the Institute of Physiology of the Ministry of Education and Science of the Republic of Kazakhstan, Al Farabi Ave. 93. Doctor of Biological Sciences, Professor e-mail: unzira@inbox.ru ORCID: <https://orcid.org/0000-0001-9162-5281>

Bakhtiyarova Sh. K., Candidate of Biological Sciences. RSE at the Institute of Human and Animal Physiology at the Institute of Physiology of the Ministry of Education and Science of the Republic of Kazakhstan, Al Farabi Ave., Candidate of Biological Sciences, e-mail: bifara.66@mail.ru ORCID: <https://orcid.org/0000-0002-6434-0130>

Baimbetova A. K., Candidate of Biological Sciences. RSE at the Institute of Human and Animal Physiology at the Institute of Physiology of the Ministry of Education and Science of the Republic of Kazakhstan, Al Farabi Ave., Candidate of Biological Sciences, e-mail: baimbetova53@mail.ru

REFERENCES

- [1] Chernykh A. M. Threats to human health when using pesticides (review) // Hygiene and sanitation. 2003. No.5. P.25-29.
- [2] Rakitsky V.N. Predictive risk of toxic effects of pesticides on the health of workers // Occupational medicine and industrial ecology. 2015. No. 10. P.5-7.
- [3] Kuksova M.A., Medvedeva A.S. Consequences of the influence of pesticides on the human body // Mater. All-Russian Scientific Conference, dedicated to the 15th anniversary of the founding of the Department of Protection in Emergency Situations. - Stavropol: Tesera, 2016. P.262-264.
- [4] Amirov N. Kh., Vasiliev V.V. Pesticides: Safety and Health. Monograph. Penza: Publishing House of the Penza State University, 2005.248 p.
- [5] Zatonskaya N.A., Chimonina I.V. Pesticides and their impact on the human body and the environment // Mater. Interregional scientific-practical. confer. "Innovative directions of development in education, economics, engineering and technology." Stavropol: ed. "Stavrolit", 2018.-P.34-38.
- [6] Report on the analysis of environmental samples within the framework of UNDP / GEF project No. 00013224 "Initial assistance to the Republic of Kazakhstan in fulfilling obligations under the Stockholm Convention on Persistent Organic Pollutants" / Head V.A. Solomin. - Almaty, 2004. http://www.pops.int/documents/convtext/convtext_ru.pdf, g. "Tera-Zher Ana", №3. <http://www.greenwomen.freenet.kz/terra.htm>
- [7] Moiseev I. P. Experimental sites for assessing the impact of POPs on human health. Report at the Second Seminar within the framework of the UNDP / GEF project "Initial Assistance to the Republic of Kazakhstan in Fulfilling Commitments under the Stockholm Convention on Persistent Organic Pollutants". UNDP, Astana, 2005, 3 p. http://www.pops.int/documents/convtext/convtext_ru.pdf
- [8] Koishekenova G.A., Tileles Zh. B., Murzataeva S.S., Rvaidarova G.O., Hamdieva O. Kh. Assessment of the mutagenic potential of water and soil contaminated with pesticides using the Ames test // Mater. XIX international scientific-practical. conf. "Actual problems of ecology and nature management." - M.: Publishing house of the Russian University of Friendship of Peoples. 2018. p. 235-239.
- [9] Pugachev V.P. Staff management. Personnel diagnostics. Specific situations. Training // Workshop. Study guide: Aspect Press, M. 2006. 316 p.
- [10] Nikolaeva E.I. Psychophysiology. Psychological physiology with the basics of physiological psychology // Textbook, 3rd edition, revised and enlarged, M.: Per Se, 2008. 624 p. Velichkovsky B.B. Using mechanisms of short-term and long-term storage of information when performing tasks for working memory // Bulletin of the Kostroma State University. them. ON THE. Nekrasov. Series: Pedagogy. Psychology. 2013. Vol.19, No. 3. P.29-32.
- [12] Maslova O. I., Baranov A. A., Namazova-Baranova L.S. Modern aspects of studying the cognitive sphere in child development // Pediatric Pharmacology. 2012, No. 9 (6). P. 72–78.
- [13] Onishchenko G. G., Novikov S. M., Rakhmanin Yu. A., Avaliani S. L., Bushtueva K.A. Basics for assessing the risk to public health when exposed to chemicals that pollute the environment. M: NII ECH and GOS, 2002. 408 p.
- [14] Omarova Z.M. Influence of pesticides on children's health // Russian Bulletin of Perinatology and Pediatrics. 2010. No. 1. P.59-64.
- [15] Inelova Z.A., Nurzhanova A.A., Zhamabalinova R.D., Zhumasheva Zh.E. and others. Phytocenotic bioindication of soils contaminated with pesticides (Talgar district, Almaty region) // Izvestiya of the National Academy of Sciences of the Republic of Kazakhstan, ecological series. 2010. No. 3 (29). P.29-33.

IRSTI 87.15.17

A.D. Akbasova¹, N.P. Aubakirov², G.D. Anarbekova², G.A. Sainova¹¹ Khoja Akhmet Yassawi International Kazakh-Turkish University, Kazakhstan, Turkistan;² Kazakh National Agrarian University, Kazakhstan, Almaty.E-mail: ecolog_kz@mail.ru; aubakirov.nurimzhan@yandex.ru

THE ROLE OF THE WELL WATERS OF THE MAUSOLEUM OF KHOJA AHMED YASAVI IN THE FORMATION OF SALTS

Abstract. The work is devoted to the study of the chemical composition of well waters located on the territory of the mausoleum complex of Khoja Ahmed Yasavi. On the basis of experimental studies, the salinity of well waters increases every year. It is especially different in 2019 when, compared to the previous 10 years (2009-2018), there was a sharp increase in the total salt content by 1,5 times in the inner well and about 2,3 times in the outer well. The reason for this is the intense pollution of atmospheric air, soil, plants and other environmental objects due to an increase in the volume of construction work resulting from this waste, the number of servicing vehicles and the emergence of a number of new anthropogenic factors. The article also considers data from the Kazhydromet of the Republic of Kazakhstan that characterize changes in natural and climatic conditions, exactly, the amount of precipitation by month. Based on the calculated data, we have shown that water evaporation is 4-5 times higher than the amount of precipitation in the region. As a result of evaporation, moisture rises through the capillaries and is further saturated with salts found in building materials. Further, the formed saturated salt solution, undergoing various transformations, such as crystallization, contributes to the formation of salt deposits on the surface of the foundation materials and further walls. This negative phenomenon is one of the factors that lead to a decrease in the stability and safety of the architectural monument.

Keywords: mausoleum of Khoja Ahmed Yasavi, well water, chemical composition, salt deposits, factor, preservation of the monument.

Introduction. Turkestan region, including Turkestan city, according to the definition of the "National Report on the Conservation and Balanced Use of Biological Diversity", is included in the second group of regions of Kazakhstan on environmental risk [1-3].

One of the most effective modern tools in the field of preservation of cultural heritage around the world is now recognized as environmental monitoring [4 - 6]. It consists of a system for monitoring the state of immovable monuments under the influence of natural and man-made environmental factors.

The negative impact of environmental risk factors negatively effects to the condition of ancient building materials. Over a long historical period, the destruction of the materials of the historical buildings is inescapable, however, its speed can be increased many times by the effects of natural or anthropogenic factors both individually and collectively. Due to the influence of these factors, climatic conditions, groundwater level, soil composition change, which usually reduces the sustainable preservation of the architectural heritage. An increase in environmental risk causes negative processes at the monument: groundwater harms foundations, capillary moisture suction - walls, the appearance of salt deposits reduce the safety of building structures [7-9].

In order to predict changes in the state of the objects of the Khoja Ahmed Yasawi mausoleum complex and to develop scientifically sound measures for their conservation, it is necessary to assess the impact on the materials of monuments of the corrosive activity of atmospheric air and groundwater. Currently, because of the climatic changes (in particular, due to the increase in the frequency of thaws in winter), the wide usage of solid fuels, intensive construction work in the Turkestan city, there has intensified a car traffic and have appeared a number of new additional sources of environmental pollution [10].

The mausoleum of Khoja Ahmed Yasawi is a very important architectural monument of the late XIV and early XV centuries. Since 2000, the mausoleum has been included in the UNESCO list of world-protected monuments and is protected by international organizations. Inclusion of the property on the World Heritage List is not just an honorary international status, but also a high responsibility to the world community. The preservation of this unique architectural monument of the entire religious Islamic world, which is considered the second Mecca in its importance, is one of the main tasks in the field of preservation and protection of the world heritage [11].

This object, being in the territory where there is an active economic activity, like other objects of historical and cultural heritage, including Kultobe, is under the negative influence of many factors. The most common problems are non-compliance with the temperature and humidity conditions inside the building, the presence of rodents, insects, birds, the development of fungi and mold, as well as air pollution. In total, the studied object is influenced by various factors, both natural (climatic, biological, physical, and other factors) and anthropogenic (pollutant emissions, vibration, new construction, disturbances in the geological environment, salinization of groundwater, etc.)

The preservation of this unique historical monument of the entire religious Islamic world is important task in the field of preservation and protection of the world heritage. Every year, as a result of the intensification of production activities, the rate of negative processes associated with the influence of natural and anthropogenic factors increases exponentially, which can lead to a destruction of the integrity of this mausoleum. In this regard, the result of our research work on initial monitoring of underground well water is of some relevance [12].

Every year, the evolutionary transformations of the historical territories of Turkestan contribute to the acceleration of processes associated with the influence of anthropogenic factors. And anthropogenic factors increase exponentially, which can lead to a destruction of the integrity of this unique architectural ensemble.

The aim of this work is to study the chemical composition of well water in order to establish their effect on the safety of building structures of the Khoja Ahmed Yasawi Mausoleum.

Methods and objects of the research. The object of the study is the well water of the mausoleum of Khoja Ahmed Yasawi. The content of calcium and the total hardness, bicarbonate, magnesium, sulfate and chloride ions were determined by the titrimetric method according to the corresponding GOSTs [13–16]. The active water reaction, characterized by the pH value, was established by the potentiometric method [17-18]. The concentration of trace elements and fluoride ions were determined by known standard methods [19]. Organoleptic indicators according to the method given in GOST [20-22].

The content of safety indicators (mass concentration of nitrate ions) was determined spectrophotometrically according to the relevant GOSTs [23-25].

To account for the total microbial number, coliform bacteria, E. Coli, and other microorganisms, accelerated methods of analysis using petrifilms [26], immunochromatographic rapid tests, and ready-made selective and indicator nutrient media are very promising. Petrifilms are intended for quantitative determination of sanitary-indicative microorganisms, contain special indicators and substrates that facilitate the accounting of grown colonies of microorganisms. When the test sample is introduced to the substrate (1-5 ml of water sample), a gel-like nutrient medium is formed, which (after incubation) takes into account the number of microorganisms. When analyzing water by membrane filtration, the petrifilm is first activated (1 ml of sterile water), then the membrane filter is placed on the petrifilm substrate and the seeding is incubated according to [26].

Results and discussion. The average annual precipitation is not more than 250 mm even in suitable years; in some years, the amount of precipitation decreases to 90-150 mm. Most rainfall occurs in the winter and spring months. In summer, there is practically no rain and therefore high air temperature and the absence of precipitation in the summer months cause a large moisture deficit. Figure 1 shows the amount of precipitation for 2018.

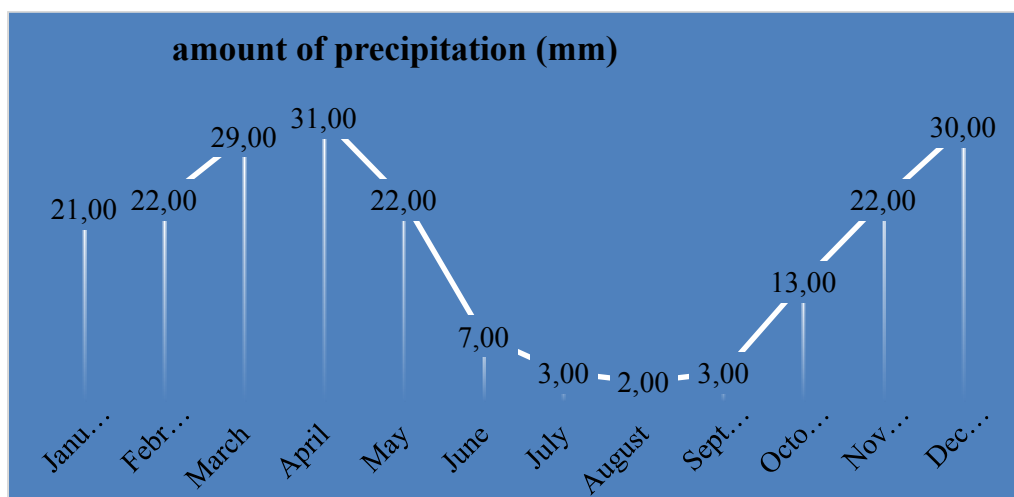

Figure 1 - Monthly changes in rainfall (mm)

As graph shows, the amount of precipitation in 2018 for Turkestan is 554.2 mm, the amount of ions in the precipitation is 21.32 mg / l: sulfate ions - 6.04, chlorides - 2.03, nitrates - 0.51, bicarbonates - 6.54, ammonium - 0.56, sodium - 0.35, potassium - 0.38, magnesium - 0.80, calcium - 4.09 mg / l, The pH of the precipitate is 6.92. The amount of moisture in the soil profile depends on the amount of evaporation. In soil formation, moisture plays a huge role, since all physicochemical, mechanical, biological, and other processes are connected with soil moisture.

The value of evaporation using the information from the weather station of the Institute "Ecology" IKTU named after H. A. Yasawi are defined by the formula: $E_0 - 0,15 n C D^{0,78} (1+0,85\omega_{100})$,

where E_0 - is the monthly evaporation rate, mm; n - is the number of days in a month; C - is a parameter depending on the average ratios between the temperature of water and air, taken equal to 1.4; D - moisture deficiency; ω - wind speed at a height of 100 cm, m / s.

According to the calculation results, the total evaporation for the year is 1413 mm, and more than 82% of the total amount falls on the growing season (April-September). In the studied region, water evaporation is 4-5 times higher than the amount of precipitation.

Scientific research conducted in the area of the mausoleum. H.A. Yasavi, indicate the need to combine the ecological, geochemical and biological characteristics during spatial and temporal consideration of the elements of the ecological chain: the source of pollution - the surface atmosphere - precipitation - soil cover - plants - water bodies for organizing and adjusting measures to reduce environmental pressure and environmentally dependent pathologies.

As shown by the results of initial visual observation by detouring the residential areas adjacent to the object under study and by experimental research of the territory and objects adjacent to the architectural complex of the Yasavi Mausoleum, an ecologically crisis situation has developed in relation to this monument. This is due to the transformation of the protected area around the mausoleum into a landfill for solid household and various industrial wastes, not counting other pollution routes. This circumstance indicates the need for drastic measures to improve the environmental situation.

In aggregate, various nature factors influence the studied object. The main sources of environmental pollution are combined in two groups:

- natural processes that determine the background content of pollutants in the components of the biosphere (in soil, water, atmospheric air, etc.);
- anthropogenic sources, including a network of intensively constructed facilities, transport accumulations, emissions from numerous boilers of private houses that use solid fuel, parking lots and garbage dumps of household waste stretching over large areas, imperfect sewage systems, many years of unplanned discharge of both solid and liquid agricultural and other waste.

During expeditionary trips from 10th January 2018 to 18th August 2019, the collection of full-scale material was carried out on the territory of the mausoleum and territories adjacent to it. Work was carried out to control water bodies, that is, groundwater and groundwater (wells).

The destruction of the materials of the monument is inevitable, but its speed can increase many times due to the increased aggressive action of saline groundwater. With this in mind, we conducted studies to determine the composition of the waters of wells located both inside and in the courtyard of the mausoleum.

Sampling of water was done from drainage wells located around the mausoleum and from a well located inside the monument in the premises of Kudukhana. In addition, another well was investigated, located to the South-East of the mausoleum of Khoja Ahmed Yasawi in the courtyard of the mosque of the XIX century.

The results are presented in tables 1-2 and figure 2, they are compared with the data obtained in the analysis of these waters of the Ecology Research Institute from 2009 to 2019.

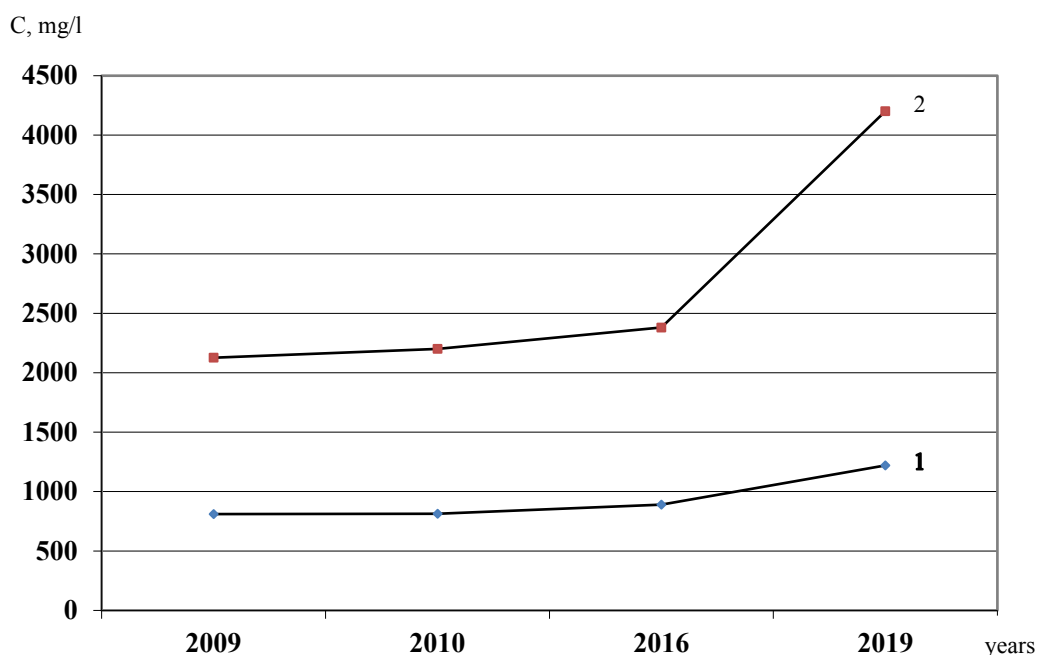

Figure 2 - The results of the analysis of the total salt content in the waters from the internal (1) and external wells (2) of the mausoleum

As can be seen from figure 2, the salinity of water in wells in 2019 compared with 2009-2016, increased approximately on average by 1.5 times inside the mausoleum and more than 2.3 times in well water located in the courtyard of the mausoleum.

The observed salinization of groundwater can have a significant negative impact on the condition of the monument. Moisture containing salts, due to capillary uplift and evaporation, saturates the pores of building materials.

Table 1 – Composition of well water of the architectural complex Yasavi (inside the mausoleum, depth - 3-5m)

№	Name of analyzes	Content of components in water	Method sensitivity	MAC in drinking water
1	2	3	4	5
1	Color, in degrees	2,314	-	no more 30
2	Turbidity, NTU/dm ³	5,554	-	2,6-3,5
3	Smell, taste, in points	0	-	no more 2-3
4	pH	8,586	0,2	6,5-9,0
5	Dry residue, mg/dm ³	1221,0	1,0	1000-1500
6	Permanganate oxidizability, mg-O/dm ³	3,64	0,01	4,0
7	Total hardness, mol / m ³	9,4	0,05	7,0

<i>Continuation of the table 1</i>				
1	2	3	4	5
8	Carbonates, mg/dm ³	n/f	0,1	6,5
9	Hydrocarbonate, mg · eq /dm ³	0,56	0,1	6,5
10	Calcium, mg/dm ³	165,5	0,4	180,0
11	Ammonium ions and ammonia, mg/dm ³	0,271	0,05	2,0
12	Nitrite, mg/dm ³	0,033	0,01	3,0
13	Nitrates, mg/dm ³	5,56	0,1	45,0
14	Iron, mg/dm ³	0,42	0,01	0,3
15	Fluoride, mg/dm ³	0,37	0,02	1,2
16	Chlorides, mg/dm ³	64,4	1,0	350,0
17	Sulphates, mg/dm ³	505,0	1,0	500,0
18	Manganese, mg/dm ³	0,019	0,01	0,1

Table 2 - the results of the analysis of well water of the architectural complex
(in the courtyard of the mausoleum, depth – 7-10m)

№	Name of analyzes	Content of components in water	Method sensitivity	MAC
1	Color, in degrees	3,680	-	≤ 30
2	Turbidity, NTU/dm ³	17,65	-	2,6-3,5
3	Smell in points	1	-	≤ 2-3
4	pH	7,724	0,2	6,5-9,0
5	Dry residue, mg/dm ³	2980,0	1,0	1000-1500
6	Permanganate oxidizability, mg·O/dm ³	2,74	0,01	4,0
7	Total hardness, mol / m ³	26,9	0,05	7,0
8	Carbonates, mg/dm ³	n/f	0,1	6,5
9	Hydrocarbonate, mg · eq /dm ³	1,35	0,1	6,5
10	Ammonium ions and ammonia, mg/dm ³	0,924	0,05	2,0
11	Nitrite, mg/dm ³	2,092	0,01	3,0
12	Nitrates, mg/dm ³	29,3	0,1	45,0
13	Iron, mg/dm ³	1,32	0,01	0,3
14	Fluoride, mg/dm ³	0,98	0,02	1,2
15	Sulphates, mg/dm ³	1360,0	1,0	500,0

The observed salinization of groundwater can have a significant negative impact on the condition of the monument. Moisture containing salts, due to capillary uplift and evaporation, saturates the pores of building materials. Salts crystallize and destroy the structure, i.e. the destruction of the foundations occurs, and this in turn will lead to a gradual shrinkage, deforming the walls. In order to avoid these processes, it is necessary to develop ways to protect the historical masonry of foundations and walls of architectural monuments from capillary movement of water.

Additionally, bacteriological analysis of water samples from wells on the territory of the mausoleum of Khoja Ahmed Yasawi was performed (table 3).

Table 3 - results of bacteriological analysis of well waters
of the mausoleum of Khoja Ahmed Yasawi (2019)

Wells	Sanitary and bacteriological indicators				
	Total quantity bacteria in 1 cm ³ of water				Escherichia coli
	15.03	10.05	12.08	05.11	
western	35	42	45	38	not detected
eastern	50	58	63	56	detected
southern	55	65	70	59	detected
Kudukhan	28	40	47	33	not detected
Juma mosque	35	43	45	38	not detected

The results of the study revealed the presence of biological contamination. Drinking water from these wells is dangerous for the health of pilgrims without appropriate decontamination measures.

Conclusion

1. Based on the results of chemical-analytical studies, an increase in the salt content in the waters of wells located on the territory of the mausoleum of Khoja Ahmed Yasavi is established every year. For 2019, the normative indicators for the total salt content are 1.5-2.3 times higher than in previous years.

2. It is shown by the calculation method that the volume of evaporating moisture is 4-5 times higher than the amount of incoming precipitation. An explanation is given of the phenomenon of the formation of salt deposits on the surface of building materials of the foundation and walls.

3. It is concluded that salt corrosion is one of the main factors contributing to a decrease in stability and a reduction in the duration of preservation of the unique ancient, architectural, priceless monument of the Khoja Ahmed Yasawi Mausoleum.

А.Д. Акбасова¹, Н.П. Аубакиров², Г.Д. Анарбекова², Г.А. Саинова¹

¹ Қ.А. Ясауи атындағы Халықаралық қазақ-түрік университеті, Түркістан, Қазақстан;

² Қазақ ұлттық аграрлық университеті, Алматы, Қазақстан

ҚОЖА АХМЕТ ЯСАУИ КЕСЕНЕСІНДЕГІ ҚҰДЫҚ СУЫНЫҢ ТҰЗ ШӨГІНДІСІНІҢ ТҰЗІЛУІНЕ ТИГІЗЕТІН ӘСЕРІ

Аннотация. Мақала Қожа Ахмет Ясауи кесенесі кешенінің аумағында орналасқан құдық суының химиялық құрамын зерттеуге арналған. Тәжірибелік зерттеулер негізінде жыл сайын құдық суының тұз мөлшерінің жоғарылағаны анықталды. Алдыңғы 10 жылмен (2009-2018 жж.) салыстырғанда 2019 жылы ішкі құдықта тұз мөлшері 1,5 есе, ал сыртқы ұңғымада шамамен 2, 3 есе жоғарылағаны айқындалды. Мұның себебі ретінде атмосфералық ауа, топырақ, өсімдік және басқа да қоршаған орта нысандарының қарқынды ластануы, осы қалдықтар нәтижесінде құрылыс жұмыстары көлемінің артуы, қызмет көрсететін көліктер саны және бірқатар жаңа антропогендік факторлардың пайда болуын алға тартуға болады.

Мақалада сонымен қатар табиғи және климаттық жағдайдың өзгеруін, атап айтқанда, әр ай бойынша жауын-шашын мөлшерін сипаттайтын Қазақстан Республикасының Қазгидромет мәліметтері қарастырылған. Есептелген мәліметтерге сүйене отырып, судың булануы аймақтағы жауын-шашын мөлшерінен 4-5 есе көп екенін көрсетті. Булану нәтижесінде ылғал капиллярлармен көтеріліп, оны құрылыс материалдарындағы тұзбен қанықтырады. Әрі қарай, мысалы, кристалданудан өтіп, әртүрлі қаныққан тұзды ерітінді іргетас материалдарының беткі қабатында және одан әрі қабырғаларда тұзды шөгінділерінің пайда болуына ықпал етеді. Бұл жағымсыз құбылыс сәулет ескерткішінің тұрақтылығы мен сақталуының азаюына әкелетін факторлардың бірі болып саналады.

Көптеген қайта қалпына келтіру жұмыстары, шұғыл континентальды климат, сонымен бірге уақыт та Қожа Ахмет Ясауи кесенесіне әсерін тигізіп отырғаны белгілі. Осыған байланысты, мәдени мұраның жылжымайтын нысанына экологиялық мониторинг жүргізу, мәселенің ауқымы мен генезисінің объективті көрінісін өңдеу және ұсынудың маңызы артып келеді. Ұңғымалық судың химиялық құрамын талдау тиісті ГОСТ-қа сәйкес титрометриялық, потенциометриялық және стандартты әдістер негізінде жүргізілді.

Түйін сөздер: Қожа Ахмет Ясауи кесенесі, құдық суы, химиялық құрамы, тұз қоры, фактор, ескерткіштердің сақталуы.

А.Д. Акбасова¹, Н.П. Аубакиров², Г.Д. Анарбекова², Г.А. Саинова¹

¹Международный казахско-турецкий университет имени Х.А.Ясауи, Казахстан, Туркестан;

²Казахский национальный аграрный университет, Казахстан, Алматы

РОЛЬ КОЛОДЕЗНЫХ ВОД МАВЗОЛЕЯ ХОДЖИ АХМЕДА ЯСАВИ В ОБРАЗОВАНИИ ВЫСОЛОВ

Аннотация. Работа посвящена исследованию химического состава колодезных вод, расположенных на территории мавзолейного комплекса Ходжи Ахмеда Ясауи. На основе экспериментальных исследований установлено возрастание с каждым годом засоленности колодезных вод. Особенно отличается 2019 г., когда по сравнению с предыдущими 10 годами (2009-2018), произошел резкий рост общего содержания солей в 1,5 раза во внутреннем колодце и приблизительно в 2,3 раза во внешнем колодце. Основанием этого является интенсивное загрязнение атмосферного воздуха, почв, растений и других объектов окружающей среды за счет увеличения объемов строительных работ, образующихся при этом отходов, количества обслуживающего

автотранспорта и появлением ряда новых антропогенных факторов. В статье также рассмотрены данные Казгидромета Республики Казахстан, характеризующие изменение природно-климатических условий, а именно количеств атмосферных осадков по месяцам. На основе расчетных данных нами показано, что испарение воды в 4-5 раз превышает количество выпадающих в регионе атмосферных осадков. В результате испарения происходит поднятие влаги по капиллярам и ее дополнительное насыщение солями, находящимися в строительных материалах. Образовавшийся насыщенный солевой раствор, подвергаясь различным преобразованиям, например, кристаллизации, способствует образованию солевых отложений на поверхности материалов фундамента и далее стен. Данное негативное явление является одним из факторов, приводящих к снижению устойчивости и сохранности архитектурного памятника.

Известно, что многочисленные реставрации, резкоконтинентальный климат и, конечно, время безжалостно оставили свой след на мавзольном комплексе Ходжи Ахмеда Ясави. В связи с этим возрастает значение экологического мониторинга недвижимого объекта культурного наследия, обработки и представления объективной картины масштабов и генезиса проблемы. Анализы химического состава колодезных вод проведен титриметрическим методом по соответствующим ГОСТам, а также потенциометрическим методом и стандартным методикам.

Ключевые слова: мавзолей Ходжа Ахмеда Ясави, колодезные воды, химический состав, солевые отложения, фактор, сохранность памятника.

Information about authors:

Akbasova Amankul Dzhakanovna, Doctor of technical sciences, Professor, Director of the Scientific Research Institute of "Ecology" at Khoja Akhmet Yassawi International Kazakh-Turkish University. <https://orcid.org/0000-0002-0842-4647>;

Aubakirov Nurimzhan Parzhanovich, Phd student, Kazakh National Agrarian University, Almaty, Kazakhstan, <https://orcid.org/0000-0002-7340-2735>;

Anarbekova Gulchat Dzhumabaevna, Candidate of Biological Sciences, Head of the Department of Ecology, Kazakh National Agrarian University, Almaty, <https://orcid.org/0000-0001-9424-2913>;

Sainova Gaukhar Askerovna, Doctor of technical sciences, Professor, Chief Researcher of the Scientific Research Institute of "Ecology" at Khoja Akhmet Yassawi International Kazakh-Turkish University, Turkistan, e-mail: ecolog_kz@mail.ru, <https://orcid.org/0000-0002-0709-7453>

REFERENCES

- [1] Mehmet, A.O., Toychibekova, G.B. Studying the underground (well) waters of the Arystanbab mausoleum / *Materials of the XIV International Scientific and Practical Conference "Actual Issues of Modern Science."* Moscow, 2012. P.166-169.
- [2] Robert Boyd., Peter J. Richerson. (2009) Culture and the evolution of human cooperation. *Philos Trans R Soc Lond B Biol Sci.* vol. 364(1533), pp. 3281–3288. doi: 10.1098/rstb.2009.0134.
- [3] Shin Maekawa., Franciza Toledo. (2001) Sustainable Climate Control For Historic Buildings In Hot And Humid Regions. *The 18th Conference On Passive And Low Energy Architecture*, Florianópolis - Brazil, 7-9 November 2001 Paper Code PL01-386, PLEA 2001.
- [4] Akbasova A.D., Sainova G.A., Dzhumanova G. (2014) Otsenka sostoyaniya mavzoleya H.A.Yasavi [Evaluation of the state of the mausoleum of H.A. Yasavi]. *Materialy Mezhd. nauchno-prakt. konf. «Nauka i obrazovaniye v XXI veke»*. Rostov, pp. 14-16.
- [5] Akbasova A.D., Sainova G.A., Beisembaeva L.S., Toychibekova G.B., Sunakbaeva D.K. (2016) Impact Assessment of Environmental Natural-Climatic and Anthropogenic Factors on State Of H.A.Yasawi Mausoleum. *Research Journal of Pharmaceutical, Biological and Chemical Sciences.* vol. 7(1), pp. 2068-2074.
- [6] Abasova A.Zh., Sainova G.A. Toychibekova G.B. (2014) Ingibirovaniye protsessa razrusheniya arkhitekturno-istoricheskogo pamyatnika mavzoleya H.A.Yasavi [Inhibition of the destruction of the architectural and historical monument of the mausoleum of H.A. Yasavi]. Vol. 5 (2) ,pp. 77-78.
- [7] Akbasova A.Zh. (2012) Vliyaniye faktorov ekologicheskikh riskov na sokhraneniye kul'turnogo naslediya [The influence of environmental risk factors on the preservation of cultural heritage]. *Vestnik MKTU im. KH.A. Yasavi. Seriya yestestvennykh nauk.* vol.3(78). pp. 105-110.
- [8] Toichibekova GB, Koyshieva G. (2011) Vozdeystviye vzheshennykh pylevykh chastits na sostoyaniye mavzoleya KH.A.Yasavi [Impact of suspended dust particles on the state of the H.A. Yasavi mausoleum]. *Vestnik MKTU im.KH.A.Yasavi.* vol. 3. pp.143-147.
- [9] Karimi, A.Z., Hosseini, B. (2012). The influence of Iranian Islamic architecture on traditional houses of Kashan. 2nd International Conference of Archi-Cultural Translations through the Silk Road. Nishinomiya, Japan; Mukogawa Women's Univ, pp. 81-86.
- [10] Azami, A.Y. (2005). Climate passive architecture in hot and dry regions of Iran. International Conference "Passive and low energy cooling for the built environment. Santorini, Greece, pp. 613-617.
- [11] Aldy J. E., Pizer W. A. (2013) Comparability of effort in international climate policy architecture. Cambridge, Mass.: Harvard Project on Climate Agreements. Harvard Project on Climate Agreements Discussion Paper 14-62
- [12] Akbasova A.D., Aubakirov N.P., Nursultan A.N. (2017) Korrozionnyye yavleniya na stroitel'nykh konstruktsiyakh mavzoleya Khodzhi Akhmeda Yasavi [Corrosion phenomena on the building structures of the mausoleum of Khoja Ahmed Yasavi]. *Mezhdunarodnyy zhurnal prikladnykh i fundamental'nykh issledovaniy.* vol 3 (2), pp. 1260-1263.

[13] Akter T., Jhohura F.T., Akter, F. *et al.* (2016) Water Quality Index for measuring drinking water quality in rural Bangladesh: a cross-sectional study. *J Health Popul Nutr.* vol 35 (4), pp. 1-12. <https://doi.org/10.1186/s41043-016-0041-5>

[14] Voda pit'evaya. Metody` opredeleniya sodержaniya sul'fatov [Drinking water. Methods for determination of sulfate content]. (2018). HOST 31940-2012 from 14th January 2014, Moscow: Standartinform Rossiiskoi Federatsii, *docs.cntd.ru*, Retrieved from: <http://docs.cntd.ru/document/1200096957> [in Russian].

[15] Voda pit'evaya. Metody` opredeleniya sodержaniya xloridov. [Drinking water. Chloride Determination Methods]. (2010). HOST 4245-72 from 14th January 1974, Moscow: Standartinform Rossiiskoi Federatsii, *docs.cntd.ru*, Retrieved from: <http://docs.cntd.ru/document/1200008214> [in Russian].

[16] Metody` opredeleniya shhelochnosti i massovoj koncentracii karbonatov i gidrokarbonatov. [Water. Methods for determination of alkalinity and mass concentration of carbonates and bicarbonates]. (2013). HOST 31957-2012 from 14th January 2014, Moscow: Standartinform Rossiiskoi Federatsii, *docs.cntd.ru*, Retrieved from: <http://docs.cntd.ru/document/gost-31957-2012>

[17] Voda pit'evaya. Metody` opredeleniya massovoj koncentracii floridov [Drinking water. Methods for determining the mass concentration of fluorides]. (2010). HOST 4386-89 from 01st January 1991, Moscow: Standartinform Rossiiskoi Federatsii, *docs.cntd.ru*, Retrieved from: <http://docs.cntd.ru/document/1200012569>

[18] Voda pit'evaya. Metody` opredeleniya zapaxa, vkusa i mutnosti. [Drinking water. Methods for the determination of odor, taste and turbidity]. (2019). HOST R 57164-2016 from 1st January 2018, Moscow: Standartinform Rossiiskoi Federatsii, *docs.cntd.ru*, Retrieved from: <http://docs.cntd.ru/document/1200140391>

[19] Vody` mineral'ny'e pit'evy'e lechebny'e, lechebno-stolovy'e i prirodny'e stolovy'e. Metody` opredeleniya nitrat-ionov. [Mineral drinking water, medicinal, medicinal and natural table. Methods for the determination of nitrate ions]. (2019). HOST 23268.9-78 from 01st January 2018, Moscow: Standartinform Rossiiskoi Federatsii, *docs.cntd.ru*, Retrieved from: <http://docs.cntd.ru/document/1200022319>

[20] Sanitary and epidemiological rules and norms hygienic standards 2.1.4.1074-01. (2002) Pit'yevaya voda. Gigiyenicheskiye trebovaniya k kachestvu vody tsentralizovannykh sistem pit'yevogo vodospabzheniya. Kontrol' kachestva. Sanitarno epidemiologicheskiye pravila i normativy [Drinking water. Hygienic requirements for water quality of centralized drinking water supply systems. Quality control. Sanitary and epidemiological rules and regulations]. Moscow: Federal Center for State Sanitary and Epidemiological Supervision of the Ministry of Health of Russia. 103 p. [in Russian]

[21] Saxena, Gaurav & Bharagava, Ram Naresh & Kaithwas, Gaurav & Raj, Abhay. (2015). Microbial indicators, pathogens and methods for their monitoring in water environment. *Journal of Water and Health* vol 13 (7). pp. 319-339. <https://doi.org/10.2166/wh.2014.275>.

[22] Yu, Yixin & Pu, X. & Li, R. & Jiang, Haozhong & Li, Yong. (2015). A study on the quantitative measurement method of organoleptic chromaticity for sandy water vol 14 (2). pp. 909-914.

[23] ASTM D1426-15 (2015). Standard Test Methods for Ammonia Nitrogen In Water, ASTM International, West Conshohocken, PA, <https://doi.org/10.1520/D1426-15>.

[24] PND F 16.1:2.2:2.3.46-06. (2008) Metodika vypolneniya izmereniy massovoy doli kislotorastvorimykh form tyazhelykh metallov i toksichnykh elementov (Cd, Pb, Cu, Zn, Bi, Tl, Ag, Fe, Se, Co, Ni, As, Sb, Hg, Mn) v pochvakh, gruntakh, donnykh otlozheniyakh [The method of measuring the mass fraction of acid-soluble forms of heavy metals and toxic elements (Cd, Pb, Cu, Zn, Bi, Tl, Ag, Fe, Se, Co, Ni, As, Sb, Hg, Mn) in soils, soils, bottom sediments, sewage sludge by inversion voltammetry] - ZAO AKVILON. - 9p. [in Russian].

[25] ASTM D1426-08 (2008). Standard Test Methods for Ammonia Nitrogen In Water, ASTM International, West Conshohocken, PA, <https://doi.org/10.1520/D1426-08>.

[26] Molina, F., López-Acedo, E., Tabla, R. *et al.* (2015). Improved detection of *Escherichia coli* and coliform bacteria by multiplex PCR. *BMC Biotechnol* 15(48). <https://doi.org/10.1186/s12896-015-0168-2>.

Achievements of Kazakhstani scientists

УДК 619 (0785.8)

СЕКРЕТ УСПЕХА

Н.П. Иванов

доктор ветеринарных наук, профессор, академик НАН РК
ТОО «Байсерке-Агро» Алматинская область, Казахстан.
E-mail: akademik-vet@mail.ru

Имя Темирхана Мынайдаровича Досмухамбетова к настоящему времени известно многим по показателям, которые были достигнуты им в различной сфере его деятельности.

Известно, что для достижения хороших результатов требуется полная самоотдача, собранность, выбор правильного направления достижения цели, умение выполнять поставленные задачи, исключительная требовательность к себе и сотрудникам. Все указанные качества присутствуют у Темирхана Мынайдаровича, он никогда не искал окольных путей к победе.

«Побеждать, а не сдаваться!» – вот подходящий для него девиз и не только в спорте, но и по жизни в целом.

Наиболее полно интеграция направлений деятельности проявляется в сельскохозяйственном производстве как наиболее сложном и весьма необходимом для государства пути его развития.

Опыт работы исследовательских университетов США, Германии и других ведущих стран мира свидетельствует, что высокое качество подготовки специалистов обеспечивается при умелом сочетании научно-производственной деятельности и учебного процесса [1].

При этом следует особо обратить внимание на организацию хозяйствующих субъектов, обеспечивающих взаимосвязь современного уровня образования, научной и производственной деятельности.

К одному из таких учреждений, где умело сочетаются образование, научная деятельность и производственная сфера можно отнести ТОО «Байсерке-Агро», основные направления развития которого являются животноводство и растениеводство.

При этом ключевую роль в подготовке кадров такого уровня играют преподаватели, имеющие глубокие знания в своей профессиональной деятельности, безусловно владеющие методологическими приемами осуществления научно-производственной деятельности, практическими навыками проведения научных исследований по актуальным направлениям аграрной и в целом биологической науки, при непосредственном участии студентов и лиц, окончивших вуз [2].

Такая связь образования, науки и практики, при умелой организации процесса производства со стороны руководителя ТОО «Байсерке-Агро» Т.М. Досмуханбетова, позволила не только готовить качественных молодых специалистов, но и научных работников (магистрантов, докторантов), а также достичь высоких производственных показателей.

Так, на базе данного хозяйства, его производственном секторе, лабораториях, где привлечены к научному поиску студенты, магистранты, магистры, докторанты, кандидаты и доктора наук, успешно решаются многие научные вопросы, имеющие важное практическое значение. Руководителями научных тем и разделов являются академики Национальной академии наук Республики Казахстан, в частности:

- академик Сагитов Абай Оразович, доктор биологических наук, профессор, генеральный директор агропарка «Оңтүстік»

- академик Иванов Николай Петрович, доктор ветеринарных наук, профессор;

- академик Оразалиев Рахим Алмабекович, доктор сельскохозяйственных наук, профессор, генетик-селекционер в растениеводстве;

- академик Садыкулов Толеухан Садыкулович, доктор сельскохозяйственных наук, профессор, генетик-селекционер по животноводству.

К этим светилам подтянулись и молодые ученые, которых такое сотрудничество удержало в научной сфере, долгое время считавшейся бесперспективной. Они получили возможность раскрыть свой потенциал, решая амбициозные задачи в структуре Bayserke Agro. Конечно, это стало возможным при хорошей организации труда, использовании результатов их многолетней научной деятельности, создания условий для проведения научно-исследовательских работ.

Так, только в последнее время в результате проведенных исследований на базе ТОО «Байсерке-Агро» в области ветеринарии и пищевой безопасности в относительно короткие сроки решены важные, с практической точки зрения, задачи, а именно:

- впервые диагностировано ранее не зарегистрированное на территории РК заболевание глаз среди завезенного поголовья КРС породы Абердино-Ангус мясного направления продуктивности;
- впервые разработан антиген для постановки РСК/РДСК, который позволяет выявлять латентные (скрытые) формы и клинически больных моракселлезом животных;
- впервые разработан терапевтический препарат для лечения глаз, пораженных моракселлезом, применение которого, в течение 7-10 дней, позволяет полностью ликвидировать заболевание;
- впервые разработан метод исследования молока коз и верблюдиц на бруцеллез;
- впервые разработан метод исследования молока кобыл на сальмонеллез;
- впервые научными и практическими работниками разработан иммунологический тест для определения фальсификации молока коз при реализации его на рынках из частных подворий;
- впервые в ТОО «Байсерке-Агро» установлены риски возможного появления и дальнейшего распространения болезней среди сельскохозяйственных животных, что является важной предпосылкой при разработке противозооотических мероприятий и может быть экстраполированы в другие хозяйствующие субъекты.

В животноводстве, которое в ТОО «Байсерке-Агро» является также многопрофильным, занимаются выращиванием племенного крупного рогатого скота мясного (казахская белоголовая, аулекольская, герефорд, абердино-ангусы) и молочного (голштино-фризская) направлений продуктивности, овцеводством – грубошерстные (едилбайская, гиссарская) и тонкорунные (казахский миринос), коневодством (более 10 различных пород), верблюдоводством (дромедары и бактрианы), пчеловодством, рыбоводством и другими отраслями сельского хозяйства. Кроме того, развивают область переработки полученной продукции, селекции племенного высокогенетического поголовья скота путем суррогатного материнства и секвинирования семени животных.

Руководством хозяйства во главе с **Темирханом Мынайдаровичем Досмуханбетовым** разработан ряд организационно-хозяйственных и санитарных мер по налаживанию правильного научно-обоснованного кормления, ухода и содержания. Были подобраны корма с оптимальным содержанием в них углеводов, перевариваемого протеина, соотношения сухих веществ структурных и концентрированных кормов, наличие сырой клетчатки и компенсирование витаминов и минералов за счет премиксов, белков, макро- и микроминеральных веществ, витаминов. Найдены определенные иммуностимуляторы, биологически активные добавки для различных половозрастных групп животных с разной продуктивностью.

К настоящему времени в ТОО «Байсерке-Агро» суточные надои молока от каждой фуражной коровы достигают 70-75 кг, масса 4-х месячных ягнят составляет 45-50 и более кг, что приближается к мировым рекордным достижениям. Показатель воспроизводства стада колебался от 90-95 телят на 100 коров, а деловой выход молодняка составляет не менее 90 процентов.

Известно, что эффективными составляющими высокой урожайности любой сельскохозяйственной культуры является сочетание наличия качественного посевного материала, правильно подобранной технологии его возделывания с учетом почвенно-климатических условий и технической обеспеченности высококлассными машинами и оборудованием, своевременной качественной уборкой урожая с последующей переработкой до конечного продукта.

Весьма важным технологическим элементом при выращивании сельскохозяйственных культур является правильно подобранная система орошения. В агрохолдинге «Байсерке-Агро» впервые в Казахстане разработано и внедрено, по инициативе Темирхана Мынайдаровича, подпочвенное капельное орошение, которое позволяет не только экономить поливную воду до 70-75%, но и снизить расходы удобрений и средств защиты растений. При этом увеличивается качество и количество урожая. Так, урожайность кукурузы, ячменя, сои и люцерны была на посевных полях ТОО «Байсерке-Агро» выше традиционной более чем в 2 раза. Внедряются различные виды

злаковых культур (пшеница, тритикале). Высокой, нередко рекордной урожайности достигают и другие культуры, в частности, при выращивании помидор в теплице получают более 50 кг овощей с одного куста.

Помимо этого, на базе агрохолдинга Досмухамбетов Темирхан Мынайдарович организовал учебный научно-производственный центр, позволяющий ученым разрабатывать комплексную систему повышения урожайности сельскохозяйственных культур, увеличения продуктивности и племенных качеств животных, обеспечения ветеринарного благополучия, а также на примере ТОО «Байсерке-Агро» осуществлять повышение квалификации специалистов и внедрять в производство достижения науки и передового опыта.

Полученные высокие результаты работы многопрофильного агрохолдинга «Байсерке-Агро» показывают проницательность руководителя Темирхана Мынайдаровича Досмухамбетова и правильность принимаемых им решений по привлечению молодежи получать образование, сочетая теорию в аудиториях высшей школы с практическими занятиями в сфере производства, проводить научные изыскания в решении актуальных вопросов сельского хозяйства, повышать производительность труда и рентабельность.

Именно умелая подготовка кадров, симбиоз науки и производства, правильная организация труда позволяют наиболее точно осуществлять правильный трансферт технологических приемов и техники в реальное производство на площадках ТОО «Байсерке Агро» и на практике доказать возможность получения высоких результатов сельскохозяйственного производства в современных условиях Казахстана, это и явилось секретом успеха руководителя агрохолдинга Bayserke Agro Темирхана Мынайдаровича Досмухамбетова!

*Доктор ветеринарных наук, профессор,
академик НАН РК – Иванов Николай Петрович*

МАЗМҰНЫ

Жаратылыстану ғылымы, медицина және ауыл шаруашылығы саласында наноматериалдарды алу

<i>Убаськин А.В., Тарасовская Н.Е., Ахметов К.И., Луньков А.И.</i> Артемия жұмыртқаларын белсендіру үшін табиғи биологиялық белсенді заттарды пайдалану мәселесі бойынша.....	5
<i>Толоконников Е. Г., Әдекенова А. С., Маслова О. В.</i> Пародонтозға қарсы препараттарды фармакоэкономикалық талдау.....	13
<i>Ермагамбет Б.Т., Казанкапова М.К., Касенова Ж.М., Наурызбаева А.Т.</i> Электропиннинг әдісімен таскөмір шайыры мен нанонтемір негізінде нанокөмірді талшықты синтездеу.....	19

Егін шаруашылығы, өсімдік шаруашылығы және зоотехникадағы биотехнология

<i>Олейченко С.Н., Егізбаева Т.Қ., Апушев А.Қ., Нүсіпжанов Н.С.</i> Қазақстанның оңтүстік және оңтүстік-шығысындағы грек жаңғағының жергілікті перспективті формаларын бағалау	27
<i>Жуманов К.Ж., Карымсақов Т.Н., Кинеев М.А., Баймұқанов А.Д.</i> BLUP әдісі негізінде голштин қара-ала бұқасының тұқымдық құндылығын тұқымының сапасы бойынша бағалау	35
<i>Утеулин К.Р., Жамбакин К.Ж.</i> Қазақстанда биопластикті алу технологиясын әзірлеу қажеттілігі туралы	42
<i>Мұстафаев Ж.С., Рысқұлбекова Л.М.</i> Іле өзенінің су жинау алабы аймағындағы су ресурсын пайдалану ерекшеліктері	49
<i>Волков Д.В., Арғынбаева Ә.М., Дауров Д. Л., Жапар Қ.Қ., Абай Ж.С., Жамбакин Қ.Ж., Шамекова М.Х.</i> Биореактордың көмегімен картоптың вируссыз отырғызу материалын жеделдетіп өндіру.....	56
<i>Иванов Н.П., Егорова Н.Н., Саримбекова С.Н., Суцих В.Ю., Илимбаева А.К.</i> Алматы облысындағы ірі қара малдың инфекцияланған тінінен бөлінген <i>Fusobacterium Necrophorum</i> биологиялық қасиеттері.....	63
<i>Чоманов У., Тултабаева Т.Ч., Шоман А.Е., Шоман А.К., Тултабаев Б.Ч.</i> Бие сүті негізінде йогурт өндірудегі биотехнологиялық процестерді зерттеу.....	73
<i>Ілгекбаева Г.Д., Махашов Е.Ш., Төлепова Г., Есімханқызы Д., Садиев С.Т.</i> <i>Nicotiana benthamiana</i> зауытындағы беттік антигенді <i>Brucella abortus</i> OMP16 білімі.....	81

Медицинадағы жалпы биология және биотехнология

<i>Бенберин В.В., Вощенкова Т.А., Нағымтаева А.А., Сибазатова А.С., Ахметова К.М., Махмұтова А.Н.</i> Гомеостазға әсер ету – қазақ популяциясындағы метаболизм синдромын зерттеу үшін бірнуклеотидті полиморфизмдерді іріктеудің өлшем-шарттары.....	86
<i>Рахимжанова Р.И., Павалкис Д., Бенберин В.В., Даутов Т.Б., Абдрахманова Ж.С., Елишбаева Э.С.</i> Нұр-Сұлтан қаласында емханаға жатқызылған COVID-19 шалдыққан науқастар өкпесінің компьютерлік томографиясын және клиникалық деректерді кешенді бағалау	94
<i>Амантай А.А., Дүйсебекова К.С.</i> Медицинада ғылыми зерттеулерді және білім беруде медициналық ақпараттық жүйелерді қолдану.....	103
<i>Алибаева К.О., Байсеркин Б.С., Сапарбеков М.К.</i> Қазақстан халқының негізгі топтары арасында АИТВ-инфекциясына экспресс-тестілеудің интеграцияланған моделін енгізудің ғылыми негіздемесі.....	109

Экология

<i>Капышева У.Н., Бахтиярова Ш.Қ., Баимбетова А.К.</i> Пестицидтік ластанудың танымдық функциялардың даму деңгейіне ұзақмерзімді әсері.....	118
<i>Ақбасова А.Д., Аубакиров Н.П., Анарбекова Г.Д., Саинова Г.А.</i> Қожа Ахмет Ясауи кесенесіндегі құдық суының тұз шөгіндісінің түзілуіне тигізетін әсері.....	125

Қазақстандық ғалымдардың жетістіктері

Табыстың құпиясы.....	133
-----------------------	-----

СОДЕРЖАНИЕ

Получение наноматериалов в области естественных наук, медицины и сельского хозяйства

<i>Убаськин А.В., Тарасовская Н.Е., Ахметов К.И., Луньков А.И.</i> К проблеме использования естественных биологически активных веществ для активации яиц артемии.....	5
<i>Толоконников Е. Г., Әдекенова А. С., Маслова О. В.</i> Фармакоэкономический анализ противопарадонтозных препаратов	13
<i>Ермагамбет Б.Т., Казанкапова М.К., Касенова Ж.М., Наурызбаева А.Т.</i> Синтез нанокompозитных волокон на основе каменноугольной смолы и наножелеза методом электроспиннинга.....	19

Биотехнология в земледелии, растениеводстве и зоотехнике

<i>Олейченко С.Н., Егизбаева Т.К., Апушеа А.К., Нусипжанов Н.С.</i> Оценка перспективные местных форм грецкого ореха для юга и юго-востока Казахстана	27
<i>Жуманов К. Ж., Карымсаков Т.Н., Кинеев М.А., Баймуканов А.Д.</i> Оценка племенной ценности быков-производителей голштинской чёрно-пёстрой породы по качеству потомства с применением метода BLUP	35
<i>Утеулин К.Р., Жамбакин К.Ж.</i> О необходимости разработок технологий получения биопластика в Казахстане.....	42
<i>Мустафаев Ж. С., Рыскулбекова Л.М.</i> Основности водопользования на территориях водосборов бассейна реки Или.....	49
<i>Волков Д.В., Аргынбаева А.М., Дауров Д. Л., Жанар К.К., Абай Ж.С., Жамбакин К.Ж., Шамекова М.Х.</i> Ускоренное производство безвосточного посадочного материала картофеля с помощью биореактора.....	56
<i>Иванов Н.П., Егорова Н.Н., Саримбекова С.Н., Сузих В.Ю., Илимбаева А.К.</i> Биологические свойства <i>Fusobacterium Necrophorum</i> , выделенных из пораженных тканей КРС в алматинской области.....	63
<i>Чоманов У., Тултабаева Т.Ч., Шоман А.Е., Шоман А.К., Тултабаев Б.Ч.</i> Исследование биотехнологических процессов при производстве йогурта на основе кобыльего молока.....	73
<i>Ильгекбаева Г.Д., Махашов Е.Ш., Тулепова Г., Есимханкызы Д., Садиев С.Т.</i> Экспрессия поверхностного антигена <i>Brucella abortus</i> OMP16 в растении <i>Nicotiana benthamiana</i>	81

Общая биология и биотехнология в медицине

<i>Бенберин В.В., Воценоква Т.А., Нагимтаева А.А., Сибатагова А.С., Ахметова К.М., Махмутова А.Н.</i> Влияние на гомеостаз – критерий отбора однонуклеотидных полиморфизмов для исследования метаболического синдрома в казахской популяции.....	86
<i>Рахимжанова Р.И., Павалкис Д., Бенберин В.В., Дауров Т.Б., Абдрахманова Ж.С., Ельшибаева Э.С.</i> Комплексная оценка компьютерной томографии легких И клинических данных у пациентов с COVID-19, госпитализированных в клинику г. Нур-Султан.....	94
<i>Амантай А.А., Дуйсебекова К.С.</i> Применение медицинских информационных систем в образовании и научных исследованиях в медицине.....	103
<i>Алибаева К.О., Байсеркин Б.С., Сапарбеков М.К.</i> Научное обоснование внедрения интегрированной модели экспресс-тестирования на ВИЧ-инфекцию среди ключевых групп населения Казахстана.....	109

Экология

<i>Капышева У.Н., Бахтиярова Ш.К., Баимбетова А.К.</i> Отдаленные последствия пестицидного загрязнения на уровень развития когнитивных функций.....	118
<i>Акбасова А.Д., Аубакиров Н.П., Анарбекова Г.Д., Саинова Г.А.</i> Роль колодезных вод мавзолея Ходжи Ахмеда Ясави в образовании высолов	125

Достижения казахстанских ученых

Секрет успеха.....	133
--------------------	-----

CONTENTS

Obtaining nanomaterials in the fields of natural sciences, medicine and agriculture

<i>Ubaskin A. V., Tarasovskaya N. E., Akhmetov K. I., Lunkov A. I.</i> On the problem of using natural biologically active substances to activate artemia eggs.....	5
<i>Tolokonnikov E. G., Adekenova A. S., Maslova O. V.</i> Pharmacoeconomical analysis of anti-periodontosis drugs.....	13
<i>Yermagambet B.T., Kazankapova M.K., Kassenova Zh.M., Nauryzbayeva A.T.</i> Synthesis of nanocomposite fibers based on rock pitch and nanoiron by electrospinning.....	19

Biotechnology in agriculture, crop production and zootechnics

<i>Oleichenko S.N., Yegizbayeva T.K., Apushev A.K., Nusipzhanov N.S.</i> Assessment of promising local walnut forms for the south and south-east of Kazakhstan.....	27
<i>Zhumanov K.Zh., Karymsakov T.N., Kineev M.A., Baimukanov A.D.</i> Estimated breeding values of servicing bulls of the holstein black-and-white breed by quality of offspring using the BLUP method	35
<i>Uteulin K.R., Zambakin K.Zh.</i> On the need to develop technologies for producing bioplastics in Kazakhstan	42
<i>Mustafayev Zh.S., Ryskulbekova L.N.</i> Fundamentals of water use in the catchment areas of the Ili river basin.....	49
<i>Volkov D., Argynbayeva A., Daurov D., Zhapar K., Abai Zh., Zhambakin K., Shamekova M.</i> Accelerated production of virus-free potato planting material using a bioreactor.....	56
<i>Ivanov N.P., Egorova N.N., Sarimbekova S.N., Sushu V.Yu., Ilimbayeva A.K.</i> Biological properties of <i>Fusobacterium Necrophorum</i> isolated from infected cattle tissues in Almaty region.....	63
<i>Chomanov U., Tultabayeva T., Shoman A.Y., Shoman, A.K., Tultabayev B.</i> Research of biotechnological processes in the production of yogurt based on mare's milk.....	73
<i>Ilgekbaeva G.D., Makhshov E.Sh., Tulepova G., Yessimkhankyzy D., Sadiev S.T.</i> Expression of the surface antigen <i>Brucella abortus</i> OMR16 in <i>Nicotiana benthamiana</i> plant.....	81

General biology and biotechnology in medicine

<i>Benberin V.V., Voshchenkova T.A., Nagymtayeva A.A., Sibagatova A.S., Akhmetova K.M., Makhmutova A.N.</i> Influence on homeostasis as the criterion for selecting single nucleotide polymorphisms for the study of metabolic syndrom in the kazakh population.....	86
<i>Rakhimzhanova R.I., Pavalkis D., Benberin V.V., Dautov T.B., Abdrakhmanova Zh.S., Yelshibayeva E.S.</i> Complex assessment of computed tomography of the lungs and clinical data in COVID-19 patients, hospitalized in the clinic in Nur-Sultan	94
<i>Amantay A.A., Duisebekova K.S.</i> Application of medical information systems in education and research in medicine.....	103
<i>Alibayeva K. O., Baiserkin B. S., Saparbekov M. K.</i> Scientific justification for the implementation of the integrated model of rapid testing for HIV-infection among key populations of Kazakhstan.....	109

Ecology

<i>Kapysheva U.N., Bakhtiyarova Sh.K., Baimbetova A.K.</i> Remote consequences of pesticide pollution on the level of development of cognitive functions.....	118
<i>Akbasova A.D., Aubakirov N.P., Anarbekova G.D., Sainova G.A.</i> The role of the well waters of the mausoleum of Khoja Ahmed Yasavi in the formation of salts.....	125

Achievements of Kazakhstani scientists

Secret of success.....	133
------------------------	-----

**Publication Ethics and Publication Malpractice
in the journals of the National Academy of Sciences of the Republic of Kazakhstan**

For information on Ethics in publishing and Ethical guidelines for journal publication see <http://www.elsevier.com/publishingethics> and <http://www.elsevier.com/journal-authors/ethics>.

Submission of an article to the National Academy of Sciences of the Republic of Kazakhstan implies that the work described has not been published previously (except in the form of an abstract or as part of a published lecture or academic thesis or as an electronic preprint, see <http://www.elsevier.com/postingpolicy>), that it is not under consideration for publication elsewhere, that its publication is approved by all authors and tacitly or explicitly by the responsible authorities where the work was carried out, and that, if accepted, it will not be published elsewhere in the same form, in English or in any other language, including electronically without the written consent of the copyright-holder. In particular, translations into English of papers already published in another language are not accepted.

No other forms of scientific misconduct are allowed, such as plagiarism, falsification, fraudulent data, incorrect interpretation of other works, incorrect citations, etc. The National Academy of Sciences of the Republic of Kazakhstan follows the Code of Conduct of the Committee on Publication Ethics (COPE), and follows the COPE Flowcharts for Resolving Cases of Suspected Misconduct (http://publicationethics.org/files/u2/New_Code.pdf). To verify originality, your article may be checked by the originality detection service Cross Check <http://www.elsevier.com/editors/plagdetect>.

The authors are obliged to participate in peer review process and be ready to provide corrections, clarifications, retractions and apologies when needed. All authors of a paper should have significantly contributed to the research.

The reviewers should provide objective judgments and should point out relevant published works which are not yet cited. Reviewed articles should be treated confidentially. The reviewers will be chosen in such a way that there is no conflict of interests with respect to the research, the authors and/or the research funders.

The editors have complete responsibility and authority to reject or accept a paper, and they will only accept a paper when reasonably certain. They will preserve anonymity of reviewers and promote publication of corrections, clarifications, retractions and apologies when needed. The acceptance of a paper automatically implies the copyright transfer to the National Academy of sciences of the Republic of Kazakhstan.

The Editorial Board of the National Academy of sciences of the Republic of Kazakhstan will monitor and safeguard publishing ethics.

Правила оформления статьи для публикации в журнале смотреть на сайте:

www.nauka-nanrk.kz

ISSN 2518-1483 (Online), ISSN 2224-5227 (Print)

<http://reports-science.kz/index.php/en/archive>

Редакторы: *М. С. Ахметова, Д. С. Аленов, А. Ахметова*

Верстка на компьютере *А. М. Кульгинбаевой*

Подписано в печать 12.10.2020.

Формат 60x881/8. Бумага офсетная. Печать – ризограф.
8,75 п.л. Тираж 500. Заказ 5.

Уважаемые авторы научных журналов НАН РК!

Президиумом НАН РК принято решение, в целях повышения международного рейтинга академических изданий, объединить следующие 3 журнала, начиная с № 5 (сентябрь-октябрь), 2020 г., с высокорейтинговыми журналами НАН РК, входящими в международные базы Scopus, WoS и др.:

1. **«Известия НАН РК. Серия биологических и медицинских наук»** объединить с журналом «Доклады НАН РК»;
2. **«Известия НАН РК. Серия аграрных наук»** – «Доклады НАН РК»;
3. **«Известия НАН РК. Серия общественных и гуманитарных наук»** – с журналом «Вестник НАН РК».

Статьи, которые публиковались в журналах «Известия НАН РК. Серия биологических и медицинских наук» и «Известия НАН РК. Серия аграрных наук», впредь будут публиковаться в журнале «Доклады НАН РК», а статьи, публикуемые в журнале «Известия НАН РК. Серия общественных и гуманитарных наук», – в журнале «Вестник НАН РК».

При подаче статей просим указывать название журнала и отрасль науки, согласно представленного перечня (см. ниже) в данном журнале:

I. Научный журнал «Вестник НАН РК» посвящен исследованиям фундаментальной науки (гуманитарные и естественные):

Редакционная коллегия принимает статьи по следующим отраслям науки:

1. Гуманитарные (экономика, юриспруденция, история и археология, политология и социология, философия, филология, педагогика и психология, литературоведение, искусствоведение)
2. Естественные (астрономия, физика, химия, биология, география и технические науки). Примеры технических наук: космонавтика, кораблестроение, машиностроение, системотехника, электротехника, электросвязь, радиоэлектроника, ядерная энергетика и т.д.

Адрес сайта «Вестник НАН РК» – <http://www.bulletin-science.kz/index.php/en/anhive>

II. Научный журнал «Доклады НАН РК» посвящен исследованиям в области получения наноматериалов, биотехнологии и экологии.

Редакционная коллегия принимает статьи по следующим отраслям науки:

1. Получение наноматериалов в области естественных наук, медицины и сельского хозяйства.
2. Биотехнология в земледелии, растениеводстве и зоотехнике.
3. Общая биология и биотехнология в медицине.
4. Экология.

Адрес сайта «Доклады НАН РК» – <http://reports-science.kz/index.php/en/archive>

Кроме того, в журналах «Известия НАН РК. Серия физико-математическая», «Известия НАН РК. Серия химии и технологий» и «Известия НАН РК. Серия геологии и технических наук» также указаны отрасли науки, по которым будут приниматься научные статьи для экспертизы и дальнейшего опубликования:

III. Научный журнал «Известия НАН РК. Серия физико-математическая» посвящен исследованиям в области математики, физики и информационной технологии.

Редакционная коллегия принимает статьи по следующим отраслям науки:

1. Математика.
2. Информатика.
3. Интеллектуальный анализ данных и распознавание образов.
4. Математическое моделирование социальных и экономических процессов.
5. Механика.
6. Механика машин и роботов.
7. Теория управления и космические исследования.
8. Физика.
9. Ядерная физика.
10. Теоретическая физика.
11. Астрономия.
12. Ионосфера.

Адрес сайта «**Известия НАН РК. Серия физико-математическая**» –

<http://physics-mathematics.kz/index.php/en/archive>

IV. Научный журнал «**Известия НАН РК. Серия химии и технологий**» посвящен исследованиям в области химии и технологий новых материалов.

Редакционная коллегия принимает статьи по следующим отраслям науки:

1. Органическая химия.
2. Неорганическая химия.
3. Высокомолекулярные соединения.
4. Физическая химия (катализ, электрохимия).
5. Технология новых материалов.
6. Технология органических веществ.
7. Технология неорганических веществ.
8. Технология химических удобрений.
9. Технология полимерных и строительных материалов и силикаты.
10. Технология пищевых продуктов.
11. Фармацевтическая химия.

Адрес сайта «**Известия НАН РК. Серия химии и технологии**» –

<http://chemistry-technology.kz/index.php/en/arhiv>

V. Научный журнал «**Известия НАН РК. Серия геологии и технических наук**» посвящен исследованиям в области геологии и технических наук:

Редакционная коллегия принимает статьи по следующим отраслям науки:

1. Геология.
2. Региональная геология.
3. Петрология.
4. Геология нефти и газа.
5. Геология и генезис рудных месторождений.
6. Гидрогеология.
7. Горное дело и геомеханика.
8. Фундаментальные проблемы обогащения минерального сырья.
9. Инженерная геология.
10. Геофизика и сейсмология.
11. География.

Адрес сайта «**Известия НАН РК. Серия геологии и технических наук**» –

<http://www.geolog-technical.kz/index.php/en/archive>